

## When ATC meets TCAS II ...

**Editorial**

The purpose of an air traffic control service is to prevent collisions and to maintain an orderly, expeditious flow of traffic.

The objective of TCAS II is simply to prevent mid-air collision – it is an independent safety net. It is inevitable that at times there will be some interaction between ATC instructions, often as a result of STCA warning, and TCAS II.

Where an ATC avoiding instruction conflicts with a TCAS RA, flight crews have sometimes responded to the ATC instruction and have not correctly followed the RA. It must be remembered that, for aircraft in close proximity, the TCAS II knowledge of the vertical situation is much better than that of ATC. Every second, TCAS II assesses if there is a risk of collision. It immediately communicates the necessary avoidance manoeuvre to the flight crew by an aural alert and the RA display. Furthermore, if both aircraft are operating TCAS II, the RAs are coordinated. The overriding action must be to **“Follow the RA”** and then, if required, to report the RA to ATC as soon as possible.

Therefore, it is essential that both pilots and controllers receive appropriate ACAS training.

TCAS II does not attempt to achieve ATC separation. It is the last resort collision avoidance safety net. Events described in this Bulletin show why it is crucial that the manner in which it can interact with ATC is well understood.

**Readers should note that new ICAO rules relating to RAs are applicable from 22 Nov 2007 – see page 2 and page 3 of this Bulletin.**

John Law  
Mode S and ACAS  
Programme Manager,  
EUROCONTROL  
November 2007

**Event 1: Correct response to RA disregarding ATC instruction**

A B737 heading South, is maintaining FL330. On a crossing track, an A320 is cleared, by mistake, to climb from FL320 to FL340.

As the A320 begins to climb, a Short Term Conflict Alert (STCA) is displayed to the controller ①. He assesses the situation and instructs the A320 to descend back to FL320 ② and the B737 to climb immediately to FL350 ③.

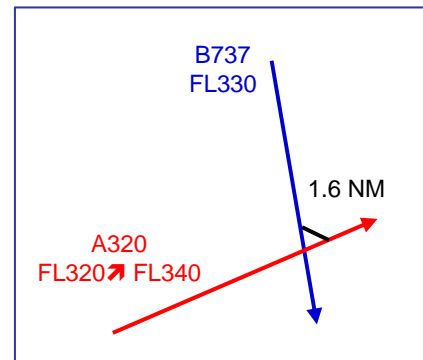

However, due to latency of the altitude display, the vertical situation shown to the controller does not match the actual one and the A320 is already above the B737 (700 ft as later reported by the A320 pilot).

The subsequent update of the controller’s radar display confirms the A320 above the B737. The controller issues an instruction to the A320 to maintain FL340 ④. However, the A320 pilot has already initiated a descent in compliance with the first instruction. Immediately after this instruction, both aircraft receive coordinated RAs ⑤ triggered by the descent initiated by the A320.

The A320 receives a “Climb” RA, which is consistent with the controller’s second avoiding instruction and the B737 a “Descend” RA contrary to the ATC instruction to climb.

**The pilots of both aircraft follow their RA and report them to the controller, who acknowledges the messages and does not provide any additional instruction.** The Closest Point of Approach is 1080 ft and 1.6 NM.

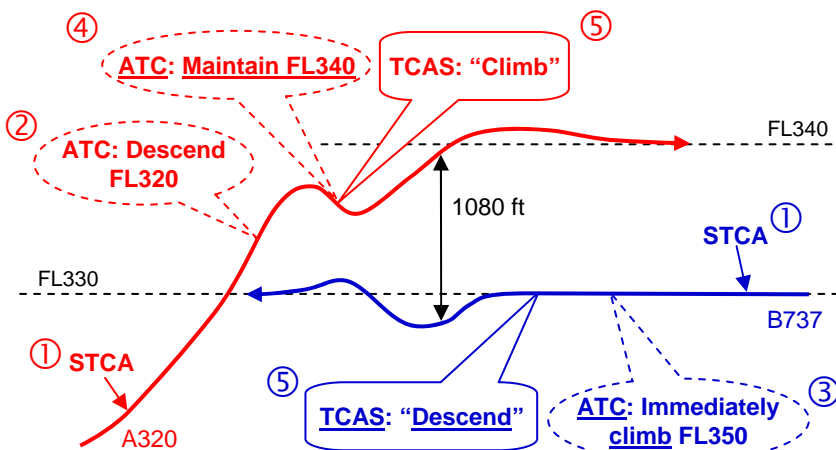

The figure depicts the aircraft vertical trajectories, not the altitudes displayed to the controller.

**“Pilots shall follow the RA even if there is a conflict between the RA and an ATC instruction to manoeuvre” (ICAO PANS-OPS)**

## Event 2: Opposite reaction to RA following ATC instruction

An A319, in contact with the approach controller, is level at FL110, heading East. A B777, heading North, is in contact with the departure controller and is cleared to FL100. The B777 pilot, however, continues to climb to FL180 by mistake.

Both controllers rapidly detect on their radar displays the unauthorised climb of the B777 and, having no time to coordinate the resolution, issue avoiding instructions for both aircraft to descend - the A319 to FL80 and the B777 to FL100. Additionally, the A319 is instructed to turn left heading 360 and the B777 to turn right heading 090.

At about the same time, both aircraft's TCAS trigger coordinated RAs:

- a "Crossing descend" for the A319
- a "Crossing climb" for the B777

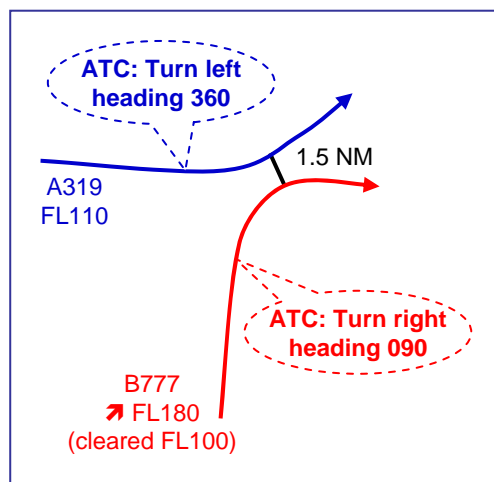
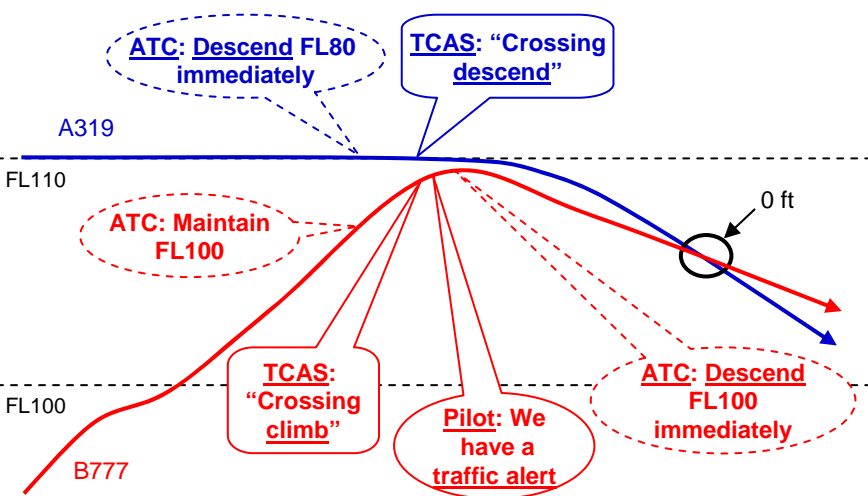

The B777 pilot reports to the controller: "We have a traffic alert". As he did not use the standard phraseology, the controller is not aware of the RA and instructs the B777 to immediately descend to FL100 and seconds later to turn further right heading 180.

In the meantime, the A319 pilot descends following the RA. However, the B777 pilot ignores the coordinated "Climb" RA and also descends in response to the ATC instruction. As a result, the aircraft are only 1.6 NM apart as they both pass FL100

**Use of correct RA reporting phraseology by the pilot will reduce the risk of ATC issuing avoiding instructions that are contradictory to the RA**

### New ICAO RA reporting procedures

On 22 November 2007 changes to ICAO PANS-OPS Doc 8168, PANS-ATM Doc 4444, and PANS-ABC Doc 8400 became effective.

Now, only those RAs that require a deviation from ATC clearance or instruction need to be reported.

The new phraseology is:

- ➔ "TCAS RA"  
(pronounced "TEE-CAS-AR-AY")

When the pilot is unable to comply with an ATC clearance or instruction because there is an RA, the appropriate message is:

- ➔ "UNABLE, TCAS RA"

Also, the pilots are required to explicitly announce the TCAS "Clear of conflict" message when the conflict is over:

- ➔ "CLEAR OF CONFLICT, RETURNING TO (assigned clearance)"; or
- ➔ "CLEAR OF CONFLICT, (assigned clearance) RESUMED"

### Examples of incorrect phraseology

Pilots often report RAs not using the ICAO standard phraseology. In some cases, the message is not explicit enough for the controller to determine whether or not a Resolution Advisory has been issued.

The figure below shows some recently documented examples.

The RA report is crucial – it serves as a notification to ATC that the aircraft is departing from its clearance as a consequence of the RA and ATC shall not issue any more clearances or instructions.

RAs requiring a departure from the current ATC clearance or instruction should be reported as quickly as possible using the standard ICAO phraseology ("TCAS RA").

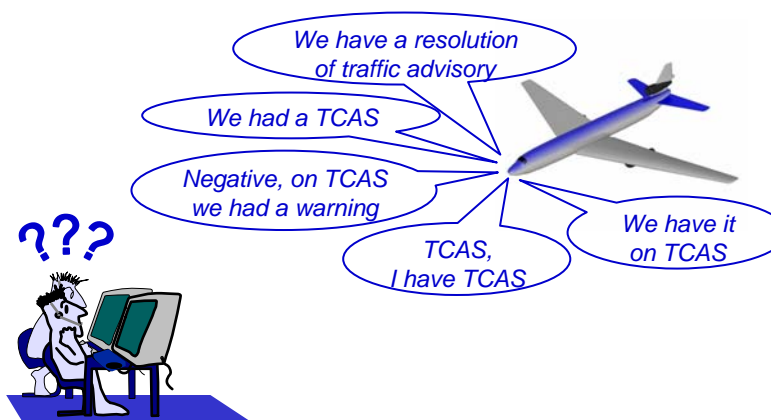

## Event 3: Efficient horizontal avoiding instructions issued by ATC

A B737, heading North, is cleared to descend from FL280 to FL200. The pilot initiates the descent and this triggers a STCA warning against a conflicting A320 at FL270, 10 NM ahead, on opposite track, that the controller has overlooked.

The controller immediately instructs the B737, which is still above the A320, to descend at the maximum rate and to turn right heading 090. Then, the controller instructs the A320 to turn immediately heading 270. While the turns begin to provide some horizontal spacing, both aircraft receive coordinated RAs.

- The B737 receives a “Climb” RA
- The A320 receives a “Descend” RA

When the B737 pilot receives the “Climb” RA, the aircraft is just increasing the rate of descent to more than 3000 fpm. Because TCAS reassesses the conflict geometry every second it reverses the RA into a “Descend now” RA. In response, the pilot increases the rate of descent to more than 4000 fpm.

In the meantime, the A320 pilot, who is following the “Descend” RA, receives a coordinated reversal “Climb now” RA. In response, the pilot only stops the descent.

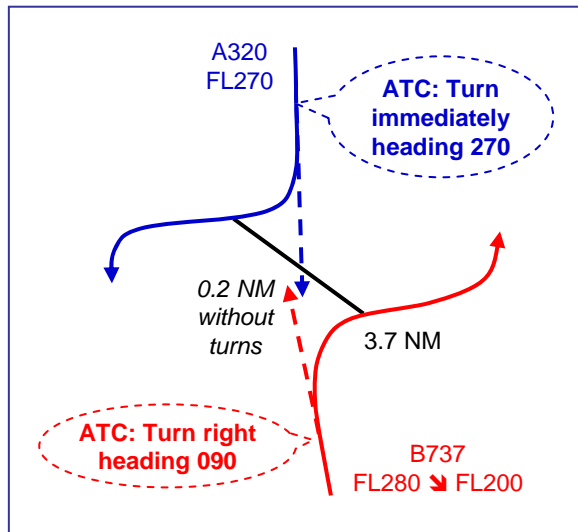
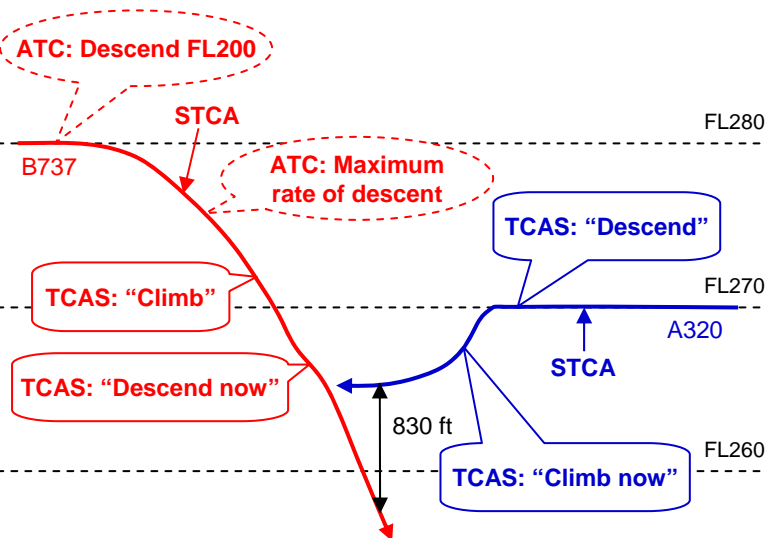

None of the RAs are reported to the controller. Consequently, when he detects on the radar display that the A320 is descending, he reminds the pilot that his clearance is FL270. The pilot then replies that he had to follow a “Descend” RA and that he is now climbing back to FL270.

As a result of the manoeuvres, both horizontal and vertical, the Closest Point of Approach is 3.7 NM and 830 ft. **Without the turns, the extrapolation of the aircraft trajectories shows that they would have passed at 0.2 NM.**

**“When a pilot reports an ACAS resolution advisory (RA), the controller shall not attempt to modify the aircraft flight path until the pilot reports “Clear of Conflict”” (PANS-ATM Doc 4444)**

**However, in the absence of an RA report, ATC horizontal avoiding instructions will not adversely affect any TCAS II RA.**

### What is STCA?

STCA is a function integrated into an ATC system. It assists the controller in preventing collision between aircraft by generating, in a timely manner, an alert of a potential or actual infringement of separation minima.

In the STCA function the current and predicted positions of aircraft with pressure altitude reporting capability are monitored for proximity. If the distance between the positions of two aircraft is predicted to be reduced to less than the applicable separation minima within a specified time period, a warning will be generated to the controller. **The parameters for determining when STCAs are generated are defined locally or regionally; there is no global standardisation.**

**No direct connection exists between STCA and TCAS II** although the aircraft transponder provides data for both TCAS II and ATC radar system. Although normally very effective in alerting controllers about actual or potential separation losses, **STCA is not as efficient as TCAS II in providing collision avoidance.**

### Amendments to PANS-ATM Doc 4444 applicable from 22 November 2007

#### Pilot – controller responsibilities during RA

**“15.7.3.3. Once an aircraft departs from its ATC clearance or instruction in compliance with an RA, or a pilot reports an RA, the controller ceases to be responsible for providing separation between that aircraft and any other aircraft affected as a direct consequence of the manoeuvre induced by the RA. The controller shall resume responsibility for providing separation for all the affected aircraft when:**

- a) the controller acknowledges a report from the flight crew that the aircraft has resumed the current clearance; or*
- b) the controller acknowledges a report from the flight crew that the aircraft is resuming the current clearance and issues an alternative clearance which is acknowledged by the flight crew.”*

## Event 4: Incorrect responses to alerts generated by TCAS and STCA

A Beech King (BE9L) aircraft, without TCAS, is heading East at FL180. A converging southbound Canadair Regional Jet (CRJ) is cleared from FL200 to FL190. There is no read-back from the CRJ pilot and so the controller repeats the descent clearance.

The pilot responds incorrectly with 'FL180' but the discrepancy is not noticed by the controller who responds "Affirm". The pilot then transmits: "Okay, descending level one eight zero, thank you" but the incorrect read-back is still not detected by the controller.

As the CRJ is passing FL192, a STCA warning is displayed on the controllers radar display, **but there is no reaction from the controller who then communicates with two other aircraft.** Finally, the controller asks the CRJ pilot to confirm his level but offers no avoiding action to either aircraft. The CRJ pilot responds: "We are level now, [callsign] and we had a TCAS... resolution advisory". The pilot, however, does not state the level that he is maintaining.

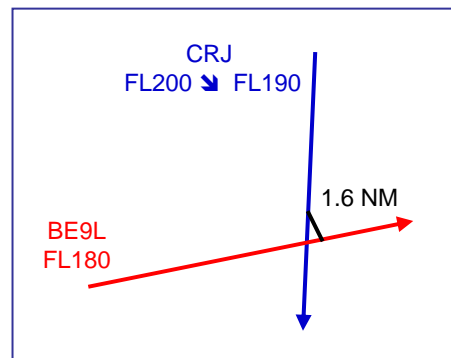

Following this, the controller and the pilot engage for almost 30 seconds in a discussion about the discrepancy in the cleared level. Although he reports the RA to ATC, **the CRJ pilot does not modify the aircraft trajectory.**

As a result, **the aircraft horizontal spacing was only 1.6 NM at the same level.** The CRJ pilot has not filed an incident report, so the type of the RA he received can not be established.

**Pilots and controllers must respond promptly to any alerts generated by TCAS and STCA to ensure that flight safety is not compromised**

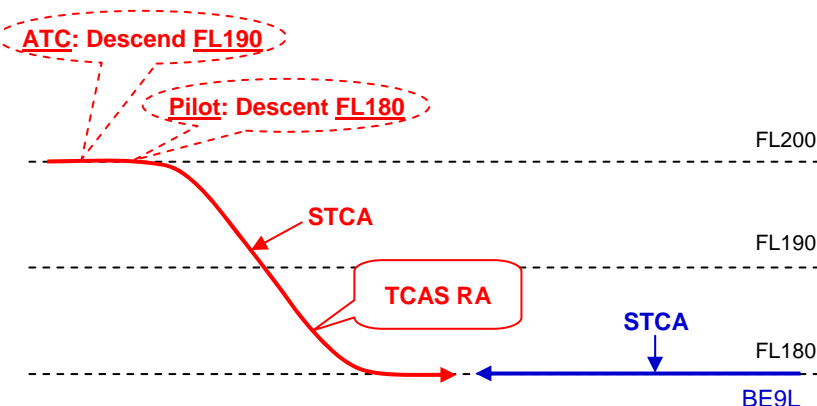

### Conclusion

When TCAS II generates an RA, **pilots must:**

- **Follow the RA, even in case of a conflicting ATC instruction;** and
- **If the RA requires a deviation from clearance, report it as soon as possible** and using the ICAO standard phraseology ("TCAS RA").

RA reporting is very important because:

- The controller is not aware of the RA until the pilot reports it; and
- It defines the moment that the controller must stop issuing instructions.

Pilots must also inform controllers about the Clear of Conflict as soon as possible.

**Controller and pilot training is essential** to ensure that procedures are appropriately applied to avoid any interference between ATC instructions and TCAS II RAs.

ANSPs and controllers are reminded that:

- **No ATC instructions must be given to a pilot who has reported an RA;**
- **ATC horizontal avoiding instructions (prior to an RA report) will not adversely affect vertical manoeuvres required by TCAS II RAs;**
- The information displayed to air traffic controllers can be several seconds old – appropriate for the provision of ATC separation but not optimized for collision avoidance purposes;
- Controllers should be given recurrent training on avoiding action techniques and applicable phraseology.

**Flight safety will be enhanced if adverse interactions between ATC and TCAS II are reduced**

**Contact: John Law**

EUROCONTROL  
Mode S and ACAS  
Programme Manager  
96, rue de la Fusée  
B-1130 Brussels

*This is one of a series of ACAS II Bulletins addressing specific TCAS operational issues. They are available on the Mode S and ACAS Programme website, as well as an ACAS II brochure and some training material.*

Tel: +32 2 729 37 66  
Fax: +32 2 729 37 19  
<http://www.eurocontrol.int/msa/acas@eurocontrol.int>