

NASA/TP-2004-213008



Flight Simulator Evaluation of Synthetic Vision Display Concepts to Prevent Controlled Flight Into Terrain (CFIT)

*Jarvis J. Arthur III, Lawrence J. Prinzel III, Lynda J. Kramer, Russell V. Parrish, and Randall E.
Bailey
Langley Research Center, Hampton, Virginia*

April 2004

The NASA STI Program Office . . . in Profile

Since its founding, NASA has been dedicated to the advancement of aeronautics and space science. The NASA Scientific and Technical Information (STI) Program Office plays a key part in helping NASA maintain this important role.

The NASA STI Program Office is operated by Langley Research Center, the lead center for NASA's scientific and technical information. The NASA STI Program Office provides access to the NASA STI Database, the largest collection of aeronautical and space science STI in the world. The Program Office is also NASA's institutional mechanism for disseminating the results of its research and development activities. These results are published by NASA in the NASA STI Report Series, which includes the following report types:

- **TECHNICAL PUBLICATION.** Reports of completed research or a major significant phase of research that present the results of NASA programs and include extensive data or theoretical analysis. Includes compilations of significant scientific and technical data and information deemed to be of continuing reference value. NASA counterpart of peer-reviewed formal professional papers, but having less stringent limitations on manuscript length and extent of graphic presentations.
- **TECHNICAL MEMORANDUM.** Scientific and technical findings that are preliminary or of specialized interest, e.g., quick release reports, working papers, and bibliographies that contain minimal annotation. Does not contain extensive analysis.
- **CONTRACTOR REPORT.** Scientific and technical findings by NASA-sponsored contractors and grantees.

- **CONFERENCE PUBLICATION.** Collected papers from scientific and technical conferences, symposia, seminars, or other meetings sponsored or co-sponsored by NASA.
- **SPECIAL PUBLICATION.** Scientific, technical, or historical information from NASA programs, projects, and missions, often concerned with subjects having substantial public interest.
- **TECHNICAL TRANSLATION.** English-language translations of foreign scientific and technical material pertinent to NASA's mission.

Specialized services that complement the STI Program Office's diverse offerings include creating custom thesauri, building customized databases, organizing and publishing research results ... even providing videos.

For more information about the NASA STI Program Office, see the following:

- Access the NASA STI Program Home Page at <http://www.sti.nasa.gov>
- E-mail your question via the Internet to help@sti.nasa.gov
- Fax your question to the NASA STI Help Desk at (301) 621-0134
- Phone the NASA STI Help Desk at (301) 621-0390
- Write to:
NASA STI Help Desk
NASA Center for AeroSpace Information
7121 Standard Drive
Hanover, MD 21076-1320

NASA/TP-2004-213008



Flight Simulator Evaluation of Synthetic Vision Display Concepts to Prevent Controlled Flight Into Terrain (CFIT)

Jarvis J. Arthur III, Lawrence J. Prinzel III, Lynda J. Kramer, Russell V. Parrish, and Randall E. Bailey
Langley Research Center, Hampton, Virginia

National Aeronautics and
Space Administration

Langley Research Center
Hampton, Virginia 23681-2199

April 2004

Acknowledgments

The authors would like to thank Mike Norman of Boeing Phantom Works for providing his expertise in developing the test scenarios, Jim Anderson of NASA Langley for making the VISTAS III research facility a reality and the CONITS team for programming the concepts.

Available from:

NASA Center for AeroSpace Information (CASI)
7121 Standard Drive
Hanover, MD 21076-1320
(301) 621-0390

National Technical Information Service (NTIS)
5285 Port Royal Road
Springfield, VA 22161-2171
(703) 605-6000

Contents

List of Tables.....	iv
List of Figures.....	iv
Abstract.....	1
Summary.....	1
Introduction	3
Controlled Flight Into Terrain	3
Terrain Awareness and Warning Systems	5
Theoretical Foundations of Synthetic Vision	6
Synthetic Vision Display Concepts	7
Retrofit Approach.....	8
Current Study.....	9
Experiment Objectives	9
Acronyms and Abbreviations	10
Methodology.....	14
VISTAS III Simulation Facility.....	14
Test Subjects.....	14
Terrain Databases	15
Experimental Test.....	17
Evaluation Tasks.....	17
Display Conditions	18
Experiment Matrix.....	20
Measures.....	20
Results	22
Quantitative Results.....	22
Rare Event CFIT Data Run.....	22
Inferences from the rare event CFIT Quantitative Results	24
Entire Approach.....	24
Entire Departure	25
Segment Analysis	27
Inferences from the Quantitative Results.....	30
Required Navigation Performance (RNP)	31
Subjective Results.....	33
Post Run Questionnaire Results.....	33
Modified Cooper-Harper Workload Scale Results for Nominal and Rare Event Runs	34
Post Run Statement Responses for Nominal Runs	35
SA-SWORD Questionnaire Results	38
Pilot Workload Rating Results	39
Pilot SA Rating Results	41
VSD Enhancement Questionnaire Results.....	43
Inferences from the On-site Qualitative Results.....	44
Post Experiment Questionnaire	44
Summary of Inferences.....	45
Conclusions	46
References	47
Appendix A: SVS Guidance.....	49
Appendix B: Required Navigation Performance	52
Appendix C: Miscellaneous Figures.....	55
Appendix D: Between Run Questionnaires	65
Appendix E: Miscellaneous Data Tables.....	67
Appendix F: Pilot Responses to Semi Structured Interview.....	68
Appendix G: Pilot Responses to Post experiment Questionnaire	91

List of Tables

Table 1. Photo-realistic image sources.....	17
Table 2. Final TerraPage database created from source data	17
Table 3. Display type variation for the ‘rare-event’ CFIT data run	19
Table 4. Experiment data run matrix; three replications for each condition	20
Table 5. Flight Segment Definitions	21
Table 6. Flight guidance symbology presented to pilot based on phase of flight and display type.....	49
Table 7. Vertical Accuracy Performance Requirements	54
Table 8. Time to Detect CFIT	67
Table 9. Subject Experience.....	67

List of Figures

Figure 1. Synthetic Vision System concept.	8
Figure 2. VISTAS III fixed-base pilot-in-the-loop workstation.....	14
Figure 3. Four databases with symbology overlays used for the experiment.....	16
Figure 4. Map view of the approach and departure (go around) task flown by the subject pilot.	18
Figure 5. Display type Variations: Baseline (top left), Size A (top right), Size X (bottom left) and HUD (bottom right).	19
Figure 6. Segmentation of subject task for statistical analysis.....	21
Figure 7. Baseline and SVS displays for nominal run (two left) and baseline and SVS displays for CFIT run (two right)	23
Figure 8. TAWS, VSD and RMI for nominal run (left) and CFIT run (right).....	23
Figure 9. Entire approach path performance errors for display concepts without texturing effects.....	24
Figure 10. Entire departure path performance errors for display concepts without texturing effects.	26
Figure 11. Lateral RMS errors for all pilots by task segment.	27
Figure 12. Vertical RMS error for all pilots.....	28
Figure 13. Summary of the approach horizontal RNP for all display types averaged across all subjects.....	32
Figure 14. Summary of approach vertical RNP for all display types averaged across all subjects.....	33
Figure 15. Subject Pilot average MCH Workload ratings for each display type.....	34
Figure 16. Average results of subjects’ responses to run statement 1.....	35
Figure 17. Average results of subjects’ responses to run statement 2.....	36
Figure 18. Average results of subjects’ responses to run statement 3.....	36
Figure 19. Average results of subjects’ responses to run statement 4.....	37
Figure 20. Average results of subjects’ responses to run statement 5.....	37
Figure 21. Average results of subjects’ responses to run statement 6.....	38
Figure 22. Comparative situational awareness among display concepts.....	39
Figure 23. Workload and SA rating scale.	39
Figure 24. Subjects’ rating of their workload for the approach and departure tasks.....	40
Figure 25. Subjects’ rating of SA for the approach and departure task.....	41
Figure 26. Subjects’ rating of SA for Texture Type for the approach and departure task.....	42
Figure 27. Percent enhancement of SA by having VSD for each display type.	43
Figure 28. Baseline approach and departure dual cue (pitch and roll command bars) flight director symbology.	49
Figure 29. SVS guidance symbology: approach (left) ghost airplane with tunnel and departure (right) integrated single cue guidance (“ball”).....	50
Figure 30. Lateral flight director for baseline concept approach tasks and for baseline and SVS concepts departure tasks.	50
Figure 31. Vertical flight director for the baseline concept approach task.....	50
Figure 32. Speed-on-pitch flight director for all display concepts departure tasks.	51
Figure 33. Lateral components of navigation error terms.....	53

Figure 34. Vertical components of navigation error terms.....	54
Figure 36. HUD with generic textured terrain.	56
Figure 37. HUD with photo-realistic textured terrain.	56
Figure 38. Size A with generic textured terrain.	57
Figure 39. Size A with photo-realistic textured terrain.	57
Figure 40. Size X with generic textured terrain.	58
Figure 41. Size X with photo- realistic textured terrain.	58
Figure 42. Baseline display on departure.	59
Figure 43. Size X display on departure.	59
Figure 44. Size X photo-textured terrain on final to EGE runway 7.....	60
Figure 45. Size X photo-realistic terrain in a left turn.....	60
Figure 46. Lateral and Vertical FTE for the baseline display.	61
Figure 47. Lateral and Vertical FTE for the SVS Size A display.	62
Figure 48. Lateral and Vertical FTE for the SVS Size X display.	63
Figure 49. Lateral and Vertical FTE for the SVS HUD.	64
Figure 50. Modified Cooper Harper scale asked between runs.....	65
Figure 51. Run Questionnaire asked between each data run.	66

Abstract

In commercial aviation, over 30-percent of all fatal accidents worldwide are categorized as Controlled Flight Into Terrain (CFIT) accidents, where a fully functioning airplane is inadvertently flown into the ground. The major hypothesis for a simulation experiment conducted at NASA Langley Research Center was that a Primary Flight Display (PFD) with synthetic terrain will improve pilots' ability to detect and avoid potential CFITs compared to conventional instrumentation. All display conditions, including the baseline, contained a Terrain Awareness and Warning System (TAWS) and Vertical Situation Display (VSD) enhanced Navigation Display (ND). Each pilot flew twenty-two approach – departure maneuvers in Instrument Meteorological Conditions (IMC) to the terrain challenged Eagle County Regional Airport (EGE) in Colorado. For the final run, flight guidance cues were altered such that the departure path went into terrain. All pilots with a synthetic vision system (SVS) PFD (twelve of sixteen pilots) noticed and avoided the potential CFIT situation. The four pilots who flew the anomaly with the conventional baseline PFD configuration (which included a TAWS and VSD enhanced ND) had a CFIT event. Additionally, all the SVS display concepts enhanced the pilot's situational awareness, decreased workload and improved flight technical error (FTE) compared to the baseline configuration.

Summary

Limited visibility is the single most critical factor affecting both the safety and capacity of worldwide aviation operations. In commercial aviation alone, over 30-percent of all fatal accidents worldwide are categorized as Controlled Flight Into Terrain (CFIT), where a mechanically sound and normal functioning airplane is inadvertently flown into the ground, water, or an obstacle, principally due to the lack of outside visual reference and situation awareness. The NASA Aviation Safety Program's Synthetic Vision Systems (SVS) Project is developing technologies with practical applications that will eliminate low visibility conditions as a causal factor to civil aircraft accidents, as well as replicate the operational benefits of flight operations in unlimited ceiling and visibility-day conditions, regardless of the actual outside weather or lighting condition. The technologies will emphasize the cost-effective use of synthetic/enhanced-vision displays, worldwide navigation, terrain, obstruction, and airport databases, and Global Positioning System (GPS)-derived navigation to eliminate "visibility-induced" (lack of visibility) errors for all aircraft categories (transports, General Aviation, rotorcraft). A major thrust of the SVS Project is to develop and demonstrate affordable, certifiable display configurations which provide intuitive out-the-window terrain and obstacle information, including guidance information for precision navigation and obstacle/obstruction avoidance for Commercial and Business aircraft.

To date, much of the SVS research has focused on introducing SVS display technology into as many existing aircraft as possible by providing a retrofit approach. This approach employs existing head down display (HDD) capabilities for glass cockpits (cockpits already equipped with raster-capable HDD's) and head-up display (HUD) capabilities for the other aircraft. Two major NASA flight tests and several simulator studies

have occurred for assessment and evaluation of the SVS developments and the retrofit approach. The HDD objective of these studies was to examine whether an SVS display could be retrofitted into an Electronic Flight Instrumentation System (EFIS) Size “A” (e.g., B-757-200) Electronic Attitude Direction Indicator (EADI) and Size “D” (e.g., B-777) Primary Flight Display (PFD). A Size “X” (8” x 10” effective display area) head-down display was also tested that may represent the display real estate available on current high-end business aircraft. The HUD objective was to examine the feasibility of the concept of retrofitting SVS display technology onto HUDs for aircraft without raster-capable HDDs. Although promising results were obtained for the SVS-HUD concept, two significant deficiencies were found in daylight HUD usage: illegible raster symbology renditions under some direct sunlight conditions and some reported terrain depiction illusions. Proposed solutions to these daylight HUD deficiencies have been identified. The feasibility of the concept of retrofitting SVS display technology with HUD’s was verified for nighttime operations. No significant deficiencies were found in nighttime HUD usage. Two terrain-texturing techniques were also evaluated during the research. One method of terrain texturing, generic texturing, involved the selection of terrain color based on absolute altitude. The other method of terrain texturing, photo-realistic texturing, employed full-color ortho-rectified aerial photographs draped over the elevation model. The results of those studies confirmed that an SVS display, with pilot-selectable field of view (FOV), could be incorporated as part of an EFIS suite and effectively replace an EADI or PFD. Regardless of HDD display size, and for both day and night HUD applications, pilots reported greater situation awareness and had lower flight technical error (FTE) while operating with the SVS displays compared to conventional displays. For both HDD and HUD applications, no significant performance effects were found between texturing techniques, although most of the pilots preferred the photo-realistic terrain texturing technique to the generic texturing technique.

The current study used the above retrofit display factors in a full factorial simulation experiment as the backdrop for conducting a ‘rare-event’ display concept comparison experiment to directly address CFIT avoidance benefits, which have been advanced as a primary motivation for SVS displays (another primary motivation is to replicate the operational benefits of flight operations in unlimited ceiling and visibility-day conditions, regardless of the actual outside weather or lighting condition). To prevent test subjects in an experiment from expecting a problem, ‘rare event’ simulation techniques require many simulation trials to produce only a few trials containing the data of interest, the rare event that allows for the potential creation of an accident scenario.

Sixteen subject pilots (15 commercial transport pilots and 1 NASA research pilot) participated in the ‘rare-event’ display concept comparison experiment recently completed in the Visual Imaging Simulator for Transport Aircraft Systems (VISTAS III) at Langley Research Center. The ‘rare-event’ (a course anomaly) was imposed only once on each pilot (with only one display condition) at the conclusion of repeated exposures to Instrument Meteorological Conditions (IMC) approach and departure operations at a terrain challenged airport using both conventional (one) and synthetic vision (six) display concepts. All seven display concepts also included an enhanced Navigation Display (ND) incorporating both a Terrain Awareness and Warning System (TAWS) display and a Vertical Situation Display (VSD), which presented a vertical profile of terrain along track. Each pilot flew twenty-two approach – departure maneuvers in IMC to the terrain challenged Eagle County Regional Airport (EGE) in Colorado. For the final run, the flight guidance cues were altered such that the departure path went into the terrain. All pilots with an SVS enhanced PFD (twelve of sixteen pilots) noticed and avoided the potential CFIT situation. The four pilots who flew the anomaly with the baseline display configuration (which included a TAWS and VSD enhanced ND) had a CFIT event. Additionally, data metrics from the experiment revealed that all of the SVS display concepts enhanced the pilots’ situational awareness, decreased workload and improved FTE compared to the baseline display configuration, during the numerous nominal and the single anomalous operations.

Introduction

Limited visibility is the single most critical factor affecting both the safety and capacity of worldwide aviation operations. In commercial aviation alone, over 30-percent of all fatal accidents worldwide are categorized as Controlled Flight Into Terrain (CFIT), where a mechanically sound and normal functioning airplane is inadvertently flown into the ground, water, or an obstacle, principally due to the lack of outside visual reference and situation awareness (Boeing, 1998; Williams et al., 2001). The NASA Aviation Safety Program's Synthetic Vision Systems (SVS) Project is developing technologies with practical applications that will eliminate low visibility conditions as a causal factor to civil aircraft accidents, as well as replicate the operational benefits of flight operations in unlimited ceiling and visibility-day conditions, regardless of the actual outside weather or lighting condition. The technologies will emphasize the cost-effective use of synthetic/enhanced-vision displays, worldwide navigation, terrain, obstruction, and airport databases, and Global Positioning System (GPS)-derived navigation to eliminate "visibility-induced" (lack of visibility) errors for all aircraft categories (transports, General Aviation, rotorcraft). A major thrust of the SVS Project is to develop and demonstrate affordable, certifiable display configurations which provide intuitive out-the-window terrain and obstacle information, including advanced pathway and guidance information for precision navigation and obstacle/obstruction avoidance for Commercial and Business aircraft.

Better pilot situation awareness (SA) during low visibility conditions can be provided by SVS displays. New technological developments in navigation performance, low-cost attitude and heading reference systems, computational capabilities, and displays allow for the prospect of SVS displays for virtually all aircraft classes. SVS display concepts employ computer-generated terrain imagery, on-board databases, and precise position and navigational accuracy to create a three dimensional perspective presentation of the outside world, with necessary and sufficient information and realism, to enable operations equivalent to those of a bright, clear, sunny day regardless of the outside weather or lighting condition.

Controlled Flight Into Terrain

Aviation has been witness to rapid advancement in technologies that have significantly improved aviation safety. The development of attitude indicators, flight management systems (FMS), radio navigation aids, and instrument landing systems (ILS) have extended aircraft operations into weather conditions with reduced forward visibility. However, as Brooks (1997) has noted, "...while standard instrumentation has served us well, enabling aviation as we see it today, literally thousands of dead souls, victims of aviation catastrophe, offer mute and poignant testimony to its imperfections. The simple, elegant dream of soaring aloft *visually, intuitively* – bird-like – remain elusive (*Italics added*, p. 17). Pilots must cope within an alphanumeric 'filter of symbology' to achieve spatial awareness; something that has repeatedly met with deadly consequences." The significant number of Part 121 CFIT accidents demonstrates how even competent and professional pilots can lose terrain awareness.

Wiener (1977) defined a CFIT accident as "one in which an otherwise-serviceable aircraft, under control of the crew, is flown (unintentionally) into terrain, obstacles or water, with no prior awareness on the part of the crew of the impending collision." Approximately 40% of all aircraft accidents are CFIT and the category accounts for 50% of all aircraft fatalities (Mathews, 1997). Khatwa and Roelen (1996) reported that 70% of CFIT accidents occurred during the descent, approach and landing phases, while only 20% occurred during the enroute portion of a flight (Scott, 1996). To date, estimates are that over 20,000 people have lost their lives in CFIT accidents.

The crash of American Airlines (AA) 965 that occurred in 1995 in Cali, Columbia is often discussed as a classic example of how CFIT accidents happen. The Boeing 757-223 struck mountainous terrain during a VOR (Very high frequency Omnidirectional Range) DME (Distance Measuring Equipment) approach under instrument flight rules and visual meteorological conditions. The Aeronautica Civil of the Republic of Columbia cited several probable causes of the accident, including “the lack of situation awareness of the flight crew regarding vertical navigation, proximity to terrain and the relative location of critical radio aids.”

CFIT accidents are often the outcome of a chain of events that contribute to a loss of situation awareness and human error, and the Cali accident was not an exception. Simmons’ (1998) identified 27 errors committed by the flight crew and air traffic control that together formed the latent and active failures for the CFIT to occur (Reason, 1990). The accident chain began with a “cleared to Cali VOR” clearance that was ambiguous and incorrectly read back, which prompted the Captain (pilot not flying) to put AA 965 on a direct course to Cali. Proceeding direct to Cali normally would not pose a terrain concern, but the action caused the Tulua (ULQ) VOR to be dropped from the active LEGS page in the FMS Control Display Unit (CDU). Later, when the Captain accepted an improper clearance to Rozo Non-Directional Beacon (NDB), he entered “R” in the direct intercept page. Unfortunately, there were two pages of SELECT DESIRED WPT (waypoint) or 12 NDBs named “R” and the Captain may have erroneously assumed that the closest R was Rozo. However, Columbia has two NDBs with an R identifier and the same frequency of 274 kHz, and the action selected the Romeo NDB instead. Because the Captain did not confirm the path on the FMS plan display, the flight crew was unaware they changed the aircraft path to an NDB located 132 nautical miles away. Although AA 965 was cleared for the approach, the Aeronautical Information Manual (AIM) (5-4-7-b) states that, “for IFR (Instrument Flight Rules) operations (Federal Aviation Regulation (FAR) Part 91.177), maintain the last-assigned altitude unless a different altitude is assigned by Air Traffic Control (ATC), or until the aircraft is established on a segment of a published route or IAP (Instrument Approach Procedure).” In other words, “cleared for approach” does not mean, “cleared to descend” and AA 965 descended from 15,000 feet before it was established on the 202-degree radial of Tulua.

The decision of AA 965 flight crew to descend despite not being established on the approach segment is incidentally the same type of error responsible for the Trans World Airlines (TWA) 514 CFIT accident at Washington Dulles International in 1974. In that accident, the Boeing 727 was cleared for VOR DME Runway 12 approach and the flight crew initiated a descent to initial approach altitude (1800 feet) before the aircraft reached the appropriate approach segment resulting in a CFIT twenty-five nautical miles northwest of the airport. The TWA 514 accident prompted the installation of ground proximity warning systems (GPWS) on all Part 121 aircraft. However, as the AA 965 accident shows, the original GPWS was not as effective at prevention of CFIT as once hoped. Once AA 965 began the descent and failed to announce their intention to ATC, the aircraft flight path put the plane in a direct trajectory with the summit of El Deluvio (8,900 feet) thirty-three miles northeast of the Cali VOR. Subsequently, a GPWS warning was sounded but was ineffective because the flight crew failed to disengage the auto-throttle and advance power to maximum, coupled with a failure to retract the speed brakes (a procedure not required by GPWS training at the time of the accident).

There is near unanimous consensus that, had the AA 965 flight crew had a graphic terrain presentation onboard, the flight crew would not had lost navigation awareness and would have realized that the aircraft was off course. This is seen in the Captain’s comments before the GPWS warning. The Captain remarked, “Ok, I’m getting it, seventeen seven. Just doesn’t look right on mine. I don’t know why.” A few seconds later, he commented, “it’s that [expletive] Tulua I’m not getting it for some reason....” Had AA 965 had an electronic display showing terrain relative to flight path, the confusion and concern of the Captain about the

approach would have been confirmed by the display. As it happened instead, moments later the GPWS sounded the “terrain, terrain, whoop, whoop, pull up ...” warning only twelve seconds before terrain impact resulting in the loss of 163 passengers with only four survivors.

Terrain Awareness and Warning Systems

The Flight Safety Foundation (FSF) CFIT Task Force reported that the absence of GPWS equipment or improper use of GPWS, and the use of “step-down” approach paths are associated with the majority of CFIT accidents. In fact, non-precision step-down approaches have a five times greater likelihood of CFIT occurrence than precision approaches. These conclusions prompted the recommendation of terrain awareness training programs and avoidance on non-precision approaches for large, transport category aircraft. In addition, the task force recommended the development of advanced technology including terrain databases, advanced GPWS, and enhanced and synthetic vision systems (Enders et al., 1996; Khatwa, & Roelen, 1996; Khatwa & Helmreich, 1999). The latter recommendation reflecting data showing that 40% of CFIT accidents involving aircraft with conventional GPWS received a late warning or improper pilot response during the years from 1988 to 1993; estimates of latency range from 10 to 15 seconds of warning (Flight International, 1996; 1997). Another 16% of CFIT accidents received no warning at all. In addition, airlines have reported hundreds of false or nuisance warnings. These figures led the Federal Aviation Administration (FAA) Human Factors Team (SA-3; 1996) to recommend the replacement of conventional GPWS with earlier, more accurate indications and warnings of potential collisions with terrain; accurate position information; prediction algorithms for aircraft flight path; and terrain depiction on electronic displays (FAA, 1996). Similar recommendations came from the National Transportation Safety Board (NTSB) in response to the AA 965 accident. The FAA (TAWS TSO C151A) and Joint Aviation Authorities (JAR OPS 1.665) have since mandated the installation of Class A Terrain Awareness and Warning Systems (TAWS) on all Part 121 aircraft.

TAWS is the generic term for warning systems that augments conventional GPWS through the presentation of terrain information on an electronic display derived from a worldwide terrain, obstacle, airport, and envelope modulation database. Currently, there are two commercially available TAWS for commercial aircraft: Enhanced GPWS (E-GPWS) and T2CAS. The E-GPWS incorporates the functions of the conventional GPWS, which has seven warning modes:

Excessive Descent Rate: “Sinkrate”, “Pull Up”

Excessive Terrain Closure Rate: “Terrain...Terrain”, “Pull Up”

Altitude Loss After Takeoff: “Don’t Sink”, “Don’t Sink”

Unsafe Terrain Clearance: “Too Low Terrain”, “Too Low Gear”, “Too Low Flaps”

Excessive Deviation Below Glideslope: “Glideslope”

Advisory Callouts: “Bank Angle”, “Minimums”, “50, 40, 30...”

Windshear Alert: “Caution Windshear”, “Windshear ... Windshear”

The E-GPWS (Honeywell MK V & MK VII) adds to these modes several “enhanced” features including envelope modulation, enhanced terrain and obstacle detection, terrain and alerting display (TAD), terrain ahead alerting, “peaks” mode, aural declutter, geometric altitude, and runway field and terrain floor clearance (Breen, 2001; Honeywell, 2000). These additional features provide a 60 second caution alert and presents terrain information to the pilot for terrain less than 2000 feet below the aircraft or within 400 feet vertical of the nearest runway elevation. The E-GPWS also can display a “peak” digital value of the highest and lowest terrain/obstacle elevation.

The second TAWS, T2CAS, combines traffic avoidance (Aircraft Collision Avoidance System; ACAS) with a ground collision avoidance system (GCAS). The GCAS provides similar features as the E-GPWS but uses a climb rate model that “looks” 132 seconds ahead and 90 degrees into a descent, turn, or climb to ensure terrain separation. Conflicts are predicted when aircraft position is compared to digital terrain and airport information, and alerts are generated when predicted flight path will intersect threatening terrain. The system then uses the climb rate model to project actual escape trajectories as part of the warning algorithm, which provides both vertical and lateral escape maneuver capability (ACSS, 2003).

Theoretical Foundations of Synthetic Vision

Research has documented the safety benefits of TAWS (e.g., de Muynck, & Khatwa, 1999; Kutchar & Hansman, 1993), and Ladkin (1997) asserted that there is near unanimity that TAWS has improved aviation safety and reduced the incidences of CFIT. However, TAWS still follows the “warn-act” model and, therefore, requires the flight crew to be reactive rather than proactive. The technology provides a warning when theoretically the flight crew has already lost spatial and situation awareness and must then perform an escape maneuver. As Moroze et al. (1999) describe, the strategy may not be optimal given the time required to adequately encode and assess the situation. The Society of Automotive Engineers (SAE) Subcommittee G-10V (1995; SAE ARD50062) echoes these concerns in detailing several human factors issues associated with terrain separation assurance displays. They stated that, “...to be effective, Terrain Separation Assurance displays must be designed to facilitate immediate interpretation, to minimize mental workload, ...and to minimize the potential for interpretation errors” (p. 54, Issue No. 6.7-6). What is needed is an intuitive system that improves pilot situation awareness with respect to spatial orientation in terms of terrain and flight path, and does not require the pilot to divert visual attention and cognitive resources away from possible external events and primary flight reference; that is, to provide a human-centered technology that can help prevent rather than just inform the flight crews of a potential collision with terrain (Snow et al., 1999). The approach requires an understanding and exploitation of the unique information processing capability of flight crews and a design of the technology and interface to accommodate perceptual and cognitive capabilities of the pilots – the difference between a “natural” and a “coded” display.

Theunissen (1997) discussed the concept of natural versus coded information. Natural information implies that the method of information acquisition by the pilot is similar to that experienced in Visual Meteorological Conditions (VMC) by looking out the window. Visual altitude judgment is an example of natural information acquisition. Coded information implies some type of information presentation to the pilot that requires interpretation to comprehend the actual value. An example of coded information is digital radio altitude. Theunissen noted that it is very important to give the pilot information required to maintain situation awareness in low-visibility conditions and that natural information presentation is intuitive and able to be perceived in a much more rapid manner than coded information. SVS displays provide a natural presentation of the outside world with information that is intuitive and easy to process. Essentially, it provides a “picture”

of the outside world, rather than disparate pieces of alphanumeric information, and best supports humans' natural acquisition and encoding of the world.

Synthetic Vision Display Concepts

A major thrust of the SVS project involves the development and demonstration of affordable, certifiable display configurations which provide intuitive out-the-window terrain and obstacle information, including advanced pathway and guidance information for precision navigation and obstacle/obstruction avoidance, for Commercial and Business aircraft. In addition to forward-fit applications, a path to retrofit this technology into today's transport aircraft fleet is also necessary to achieve the desired safety benefits, since 66% of today's transport aircraft fleet is equipped with only electro-mechanical cockpit instrumentation.

NASA's SVS concept (Figure 1) provides a real-time, unobscured synthetic view of the world for the pilot. The display is generated by visually rendering an on-board terrain database (with additional airport and obstacle database information as necessary) using precise position and navigation data obtained through GPS (Global Positioning System) data, with augmentation possibly from differential correction sources such as Local Area Augmentation Systems (LAAS) and Wide Area Augmentation Systems (WAAS), as well as blending from on-board Inertial Navigation System (INS) information. The SVS display concept includes the intuitive display of intended flight path using a tunnel or pathway-in-the-sky presentation. When coupled with a synthetic view of the outside world, the spatically integrated depiction of the intended flight path and its relation to the world provides an intuitive, easily interpretable display of flight critical information for the pilot. Active imaging sensors (e.g., Forward Looking Infra Red (FLIR), millimeter wave (MW) radar), real-time hazard information (e.g., weather and wake vortices), and traffic information as provided by Traffic Alert and Collision Avoidance System (TCAS), Automatic Dependent Surveillance – Broadcast (ADS-B) and Traffic Information Services - Broadcast (TIS-B) can additionally enhance this synthetic vision display concept (SVDC). Although the display representation to the pilot is synthetically derived, object detection and integrity monitoring functions are envisioned to ensure sufficient accuracy and reliability for certification.

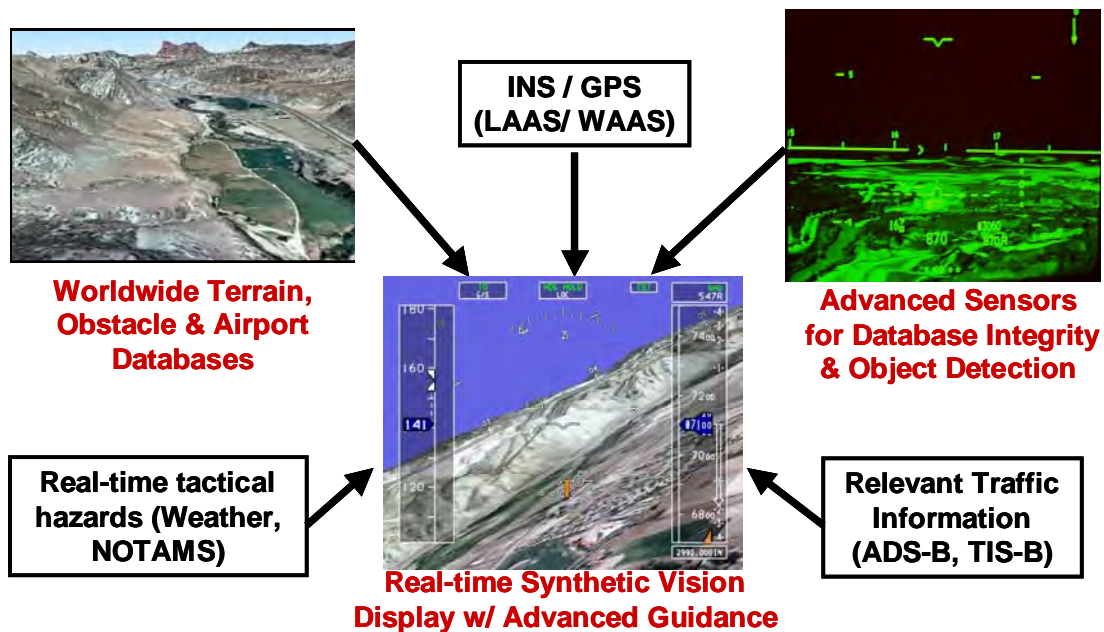

Figure 1. Synthetic Vision System concept.

Retrofit Approach

To date, much of the NASA SVS research has focused on introducing SVS display technology into as many existing aircraft as possible by providing a retrofit approach. This approach employs existing head down display (HDD) capabilities for glass cockpits (cockpits already equipped with raster-capable HDD's) and head-up display (HUD) capabilities for the other aircraft. Two major NASA flight tests have occurred for assessment and evaluation of the SVS developments. Both flight tests have used the NASA/Langley (LaRC) Research Center's Airborne Research Integrated Experimental System (ARIES) Boeing B-757-200 aircraft. The first flight test (Glaab et al., 2003) was flown Sept-Oct 2000 in nighttime operations at Dallas-Ft. Worth (FAA Identifier: DFW). The second flight test (Bailey et al., 2002A) was flown Aug-Sept 2001 in simulated daylight Instrument Meteorological Conditions (IMC) at Eagle County Regional Airport, CO (FAA Identifier: EGE).

The objective of these tests and past simulator studies was to examine whether an SVS display could be retrofitted into an Electronic Flight Instrumentation System (EFIS) Size "A" (e.g., B-757-200) Electronic Attitude Direction Indicator (EADI) and Size "D" (e.g., B-777) Primary Flight Display (PFD). In addition to these display sizes, both a Size "X" head-down display and an SVS HUD concept were evaluated. The Size X display represented the test case of display real estate that may be available on current high-end business aircraft. Each of the display size variations of the SVS HDD concepts evaluated included a pilot-selectable field of view (FOV) feature to address the fixed display size limitations. The HUD objective was to examine the feasibility of the concept of retrofitting SVS display technology onto HUDs for aircraft without raster-capable HDDs. Although promising results were obtained for the SVS-HUD concept, two significant deficiencies were found in daylight HUD usage: illegible raster symbology renditions under some direct sunlight conditions and some reported terrain depiction illusions. Proposed solutions to these daylight HUD deficiencies have been presented by Bailey (2002B). The feasibility of the concept of retrofitting SVS display technology with HUD's was verified for nighttime operations. No significant deficiencies were found in nighttime HUD usage. Two terrain-texturing techniques were also evaluated during the research. One

method of terrain texturing, generic texturing, involved the selection of terrain color based on absolute altitude. The other method of terrain texturing, photo-realistic texturing, employed full color ortho-rectified aerial photographs draped over the elevation model. The results of those studies confirmed that an SVS display, with pilot-selectable FOV, could be incorporated as part of an EFIS suite and effectively replace an EADI or PFD. Regardless of HDD display size, and for both day and night HUD applications, pilots reported greater situation awareness and had lower flight technical error (FTE) while operating with the SVS displays compared to conventional displays. For both HDD and HUD applications, no significant performance effects were found between texturing techniques, although most of the pilots preferred the photo-realistic terrain texturing technique to the generic texturing technique.

Current Study

To prevent test subjects in an experiment from expecting a problem, ‘rare-event’ simulation techniques require many simulation trials to produce only a few trials containing the data of interest, the rare event that allows for the potential creation of an accident scenario. The current study used the above retrofit display factors in a full factorial simulation experiment as the backdrop for conducting a ‘rare-event’ display concept comparison experiment to directly address CFIT avoidance benefits, which has been advanced as a primary motivation for SVS displays (another primary motivation is to replicate the operational benefits of flight operations in unlimited ceiling and visibility conditions, regardless of the outside weather). The ‘rare-event’ (a course anomaly) was imposed only once on each pilot (with only one display condition) at the conclusion of repeated exposures to IMC approach and departure operations at a terrain challenged airport (EGE) using both conventional (one) and synthetic vision (six) display concepts (two SVS HDD concepts and one HUD concept, with the two texturing techniques) without the anomaly. All seven display concepts also included an enhanced Navigation Display (ND) incorporating both a TAWS and a Vertical Situation Display (VSD, which presented a vertical profile of terrain along track). Both the TAWS (Muynck, & Khatwa, 1999) and VSD (Prevot, 1998) concepts have been researched independently. These displays by themselves have limitations; however, an integrated SVS solution involving perspective terrain on PFD, and TAWS and VSD on an enhanced ND, has the potential to provide the complete terrain depiction.

Experiment Objectives

The main purpose of the experiment was to directly address SVS CFIT avoidance benefits, but the data gathered during the backdrop retrofit display factors experiment was used to confirm/deny the results obtained in prior research efforts (Glaab et al., 2003, Bailey et al., 2002A) by:

1. Determining whether an SVS can improve the pilot’s ability to detect a potential CFIT scenario compared to a baseline 757 EFIS display system with a TAWS and VSD enhanced ND.
2. Confirming pilot usability / acceptability and Situational (Terrain) Awareness and workload benefits provided by a NASA SVDC Head-Up Display (SVDC-HUD) and the potential of the SVDC-HUD as a retrofit display solution for SVS concepts in Non-Glass cockpits (this experimental objective was constrained by the lack of high visual fidelity in simulated HUD presentations).
3. Confirming pilot usability / acceptability and Situational (Terrain) Awareness and workload benefits provided by various-sized SVDC Head-Down Displays (SVDC-HDD).
4. Confirming pilot usability / acceptability and Situational (Terrain) Awareness provided by photo-textured and generically-textured terrain database SVS concepts within NASA SVS concepts (HUD; Head-down Sizes A/B, X) in support of the retrofit display concept evaluation and SVDC development.
5. Assessing closed-loop performance during manually flown landing approach and departure (go-around) maneuvers in a terrain-challenged operational environment with and without SVS display concepts, and quantifying performance with respect to required navigation performance (RNP) procedures.

Acronyms and Abbreviations

AA	American Airlines
ACAS	Aircraft Collision Avoidance System
ADS-B	Automatic Detection Surveillance - Broadcast
AGL	Above Ground Level
AIM	Aeronautical Information Manual
ANOVA	Analysis of Variance
ARIES	Airborne Research Integrated Experiment System
ATC	Air Traffic Control
CDU	Control Display Unit
CFIT	Controlled Flight Into Terrain
COTS	Commercial Off The Shelf
DEM	Digital Elevation Model
DFW	FAA airport identifier for Dallas/Fort Worth International Airport
DME	Distance Measuring Equipment
EADI	Electronic Attitude Direction Indicator
EFIS	Electronic Flight Instrumentation System
EGE	FAA airport identifier for Eagle County, Colorado Regional Airport
E-GPWS	Enhanced Ground Proximity Warning System
FAA	Federal Aviation Administration
FAR	Federal Aviation Regulation
FLIR	Forward-Looking Infra-Red
FMS	Flight Management System
FOV	Field of View

FPA	Flight Path Angle
FSF	Flight Safety Foundation
FTE	Flight Technical Error
GCAS	Ground Collision Avoidance System
GEOTIFF	Georeferenced Tagged Image File Format
GPS	Global Positioning System
GPWS	Ground Proximity Warning System
HDD	Head-Down Display
HUD	Head-Up Display
IAP	Instrument Approach Procedure
IFR	Instrument Flight Rules
ILS	Instrument Landing Systems
IMC	Instrument Meteorological Conditions
INS	Inertial Navigation System
LAAS	Local Area Augmentation System
LaRC	Langley Research Center
MASPS	Minimum Aviation System Performance Standards
MSL	Mean Sea Level
NASA	National Aeronautics and Space Administration
ND	Navigation Display
NDB	Non-Directional Beacon
NED	National Elevation Dataset
nmi	nautical mile
NOTEM	Notice to Airmen

NTSB	National Transportation Safety Board
PC	Personal Computer
PFD	Primary Flight Display
RMI	Radio Magnetic Indicator
RMS	Root Mean Square
RNAV	RNP Area Navigation
RNP	Required Navigation Performance
SA	Situation Awareness
SAE	Society of Automotive Engineers
SA-SWORD	Situational Awareness – Subjective Workload Dominance
SNK	Student-Newman-Keuls
SV	Synthetic Vision
SVDC	Synthetic Vision Display Concepts
SVS	Synthetic Vision Systems
TAD	Terrain and Alerting Display
TAWS	Terrain Awareness and Warning System
TCAS	Traffic Collision and Avoidance System
TIS-B	Traffic Information Services - Broadcast
TOGA	Takeoff/Go-around
TWA	Trans World Airlines
USGS	United States Geological Survey
UTM	Universal Transverse Mercator
VISTAS	Visual Imaging Simulator for Transport Aircraft Systems
VMC	Visual Meteorological Conditions

VNAV	Vertical navigation
VOR	Very high frequency Omni-direction Radio
VSD	Vertical Situation Display
WAAS	Wide Area Augmentation System

Methodology

VISTAS III Simulation Facility

The experiment was conducted in the Visual Imaging Simulator for Transport Aircraft Systems (VISTAS) III part task simulator at NASA Langley Research Center (Figure 2). The single pilot fixed-based simulator consists of a 144 degree by 30 degree out-the-window visual, a simulated HUD, a large field, reconfigurable screen for HDD and pilot input controls. A HUD is simulated by independently projecting HUD symbology (in monochrome green) on the out-the-window display immediately in front of the pilot. Though the simulated HUD is projected over 9 feet away from the pilot (one of the factors that limit the fidelity of the simulated HUD), the FOV for the simulated HUD is comparable to a standard HUD. For this experiment, the out-the-window scene was used only during training.

The rudimentary pilot controls in the VISTAS III workstation are a left side-arm controller, left/right throttle controls with take-off/go-around (TOGA) button, rudder pedals, left/right toe brakes, landing gear switch and a Personal Computer (PC) track ball for display related pilot inputs. The track ball was used to select ND range scale and the SVS FOV.



Figure 2. VISTAS III fixed-base pilot-in-the-loop workstation.

Test Subjects

A total of sixteen test subjects participated in this experiment. Fifteen subjects were airline pilots and one subject was a NASA researcher. The subjects from commercial airlines consisted of four captains and eleven first officers. The NASA researcher was an experienced Air Force transport pilot with no previous knowledge of SVS concepts. All subjects had HUD experience and all airline pilots had current commercial licenses. The subjects had an average 19.6 years of flying experience with an average 8200 hours logged (Appendix E, Table 9). The subjects were given a 30-minute briefing to explain the retrofit concept and the expected subject task. After the briefing, a 1.5-hour training session was conducted to familiarize the subjects with the aircraft model, display symbologies and controls. The 'rare-event' scenario was not discussed, although the pilot's responsibility for maintaining terrain clearance at all times was stressed. Data collection

lasted approximately 4 hours followed by a 1 hour semi-structured interview. The entire session including lunch and breaks lasted approximately 8 hours.

Terrain Databases

The terrain databases used for this experiment covered a 95 nautical mile (nmi) by 95 nmi area centered at the EGE airport. Jeppesen provided the source elevation data for the EGE databases based on U.S. Geological Survey (USGS) National Elevation Dataset (NED). The delivered elevation data was 1-arcsecond (30 meter) in Digital Elevation Model (DEM) format, with a Universal Transverse Mercator (UTM) WGS84 projection and covered a 100 nmi square geographically centered about EGE. The accuracy of the source data was within 12 meters (90% of data) horizontal and 7 meters (90% of data) vertical. From this DEM, four real time rendering databases were created (Figure 3):

1. SVS-HDD full color photo-realistic texture (Figure 3, top left)
2. SVS-HDD full color elevation based (generic) texture (Figure 3, top right)
3. SVS-HUD monochrome green photo-realistic texture (Figure 3, bottom left)
4. SVS-HUD monochrome green elevation based (generic) texture (Figure 3, bottom right)

The monochrome databases were created because HUD's are monochrome green. The monochrome databases were designed for monochrome displays to ensure proper rendering (i.e., no holes in database due to lack of green color). Each EGE terrain database was built using commercially available terrain building software. The SV terrain databases were written to a UTM format and rendered using a commercially available scene graph software package. An EGE airport model was created using a commercial off the shelf (COTS) modeling software and placed into the SV database.

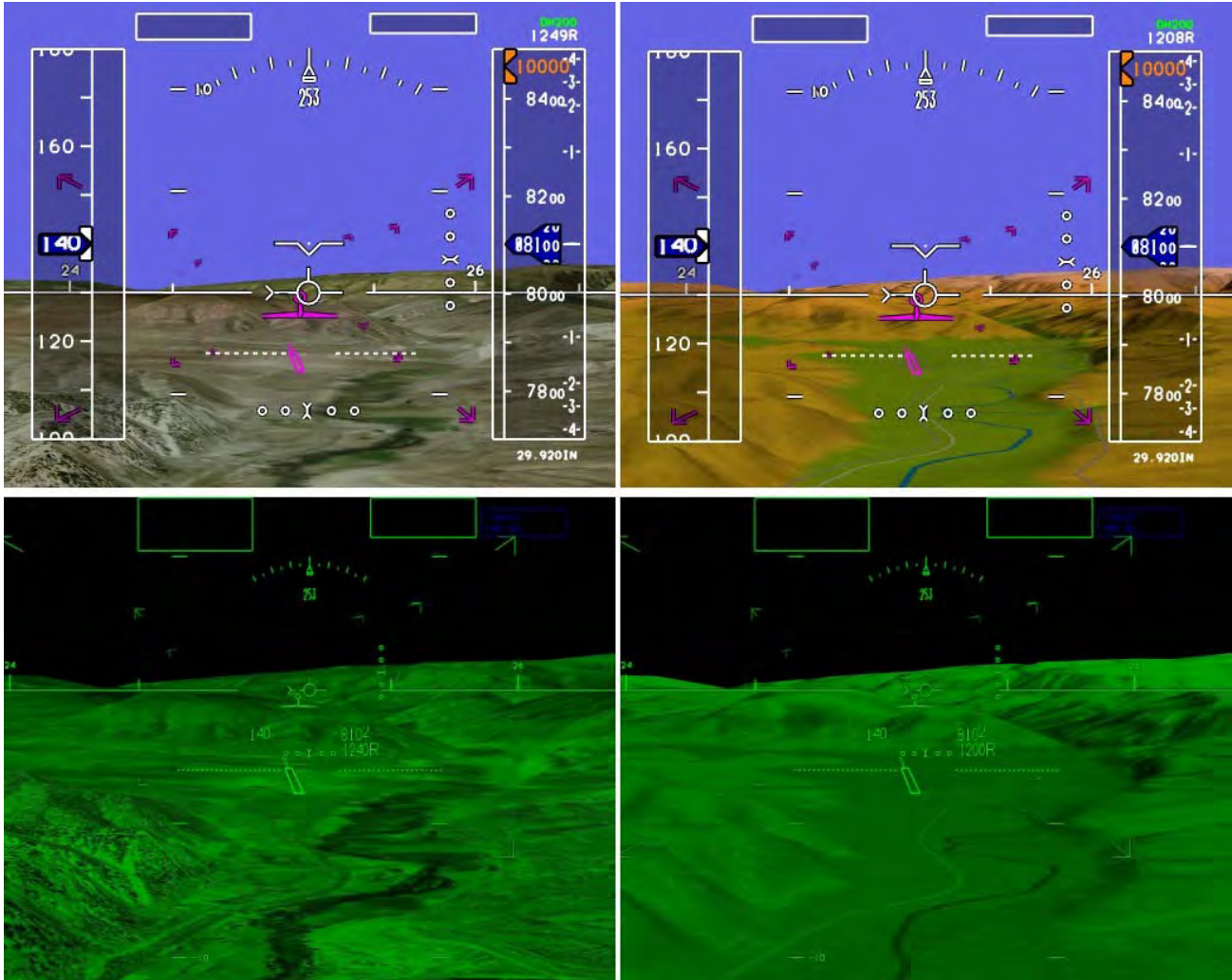

Color photo-realistic (top left), Green photo-realistic for HUD (bottom left), Color generic (top right), Green generic for HUD(bottom right).

Figure 3. Four databases with symbology overlays used for the experiment.

To create the full color photo-realistic terrain database, multi-resolution aerial imagery (Georeferenced Tagged Image File Format (GeoTIFF) ranging from 1 to 16 meters/pixel) was overlaid on the DEM database. The source data included three images sets of 1, 4, and 16 meter resolution (see Table 1), which were nested, with the highest resolutions centered about the EGE runway. The final database (Table 2) was created from the source data after a rendering trade off study. The trade off study maximized the amount of texturing to be rendered (most photo-realistic) while maintaining a 30 Hz update frame rate. A significant effort was made before the database build to color balance the various aerial images to produce a non-tiled, single brightness and contrast database appearance. To create the monochrome green photo-realistic database, full color aerial photographs were converted to a single green color with multiple shadings using a freeware image-editing tool.

Table 1. Photo-realistic image sources

Image resolution	Provider	Format	Area Coverage (centered on EGE)
1-meter per pixel	NGS	GeoTIFF WGS84 UTM Zone 13	17.2 nmi (east/west) by 6.8 nmi (north/south)
4-meter per pixel	ImageLinks	GeoTIFF WGS84 UTM Zone 13	29.7 nmi (east/west) by 32 nmi (north/south)
16-meter per pixel	ImageLinks	GeoTIFF WGS84 UTM Zone 13	104.2 nmi (east/west) by 104.2 nmi (north/south)

Table 2. Final TerraPage database created from source data

Image Resolution	Coverage
2-meter per pixel	2.1 nmi by 0.7 nmi
4-meter per pixel	25 nmi by 25 nmi
16-meter per pixel	95 nmi by 95 nmi

To create the generic textured terrain database, a color mapping technique (i.e., “elevation shading”) was developed. The color scheme chosen was similar to Aeronautical Chart legends with slight modification to show more contrast over the elevation range in the database. The colors ranged from greens (field elevation of EGE), to browns, to light tans, to off-white with the greens representing the lower elevations bands, and the off-white representing the highest elevation band. Twelve bands were used, segmented into 250-meter ranges. To create the monochrome green generic database, shades of green were used to represent elevation changes. The green color intensities associated with each elevation level varied in an incremental fashion from the lowest to highest level. Thus, no two elevation levels had the same green value. Main cultural features, such as railroads, roads, lakes, and rivers, were placed in the generic textured terrain databases.

Experimental Test

Evaluation Tasks

The test subjects were asked to fly a circling visual approach to EGE runway 7 in IMC (Figure 4) with no out-the-window visibility. At 200 feet above ground level (AGL), a go around was declared and a departure path was followed. Both the approach and departure paths were slightly modified published approach and departure paths. The simulated aircraft used for this experiment was a Boeing 757. Both the approach and departure speeds were 140 knots. All scenarios were flown with light to moderate turbulence and no wind. For the approach part of the task, auto throttles were enabled, flaps were set to 30 degrees and the landing gear was down. At 200 ft AGL, a go around was executed (the pilot pressed the TOGA button) and the loss of one engine was simulated (for this study, both throttles were set to 40% power to simulate single engine power, a condition that entailed remaining low in the terrain during departure). Then, the pilot raised the landing gear and the flaps were set to 5 degrees. The task for the departure path was to follow a heading of 050 degrees until the aircraft was at 6.8 DME from the Snow VOR. At the 6.8 DME point, the pilot was then to follow the 059 radial from the Snow (FAA designation SXW) VOR. The data collection run ended at the 12.0 DME point from SXW. For the final data run of the experiment, the rare event scenario, the flight guidance was altered on the departure path (dotted path in Figure 4). Both the flight path and guidance cues directed the airplane into the side of a mountain peak.

TAWS aural alerts were demonstrated during the training session but were disabled for data runs. Because of the nature of the scenarios, the TAWS aural alerts were frequent and distracting even when following a known correct path (in the actual flight tests operations at EGE, it was necessary to disable the aural warning for the more rudimentary ground proximity warning system, GPWS, of the LaRC Boeing 757). It should be mentioned that the aural alerts would have occurred on all runs including the non CFIT scenarios, thus, the aural alert would not have aided in CFIT detection for these scenarios.

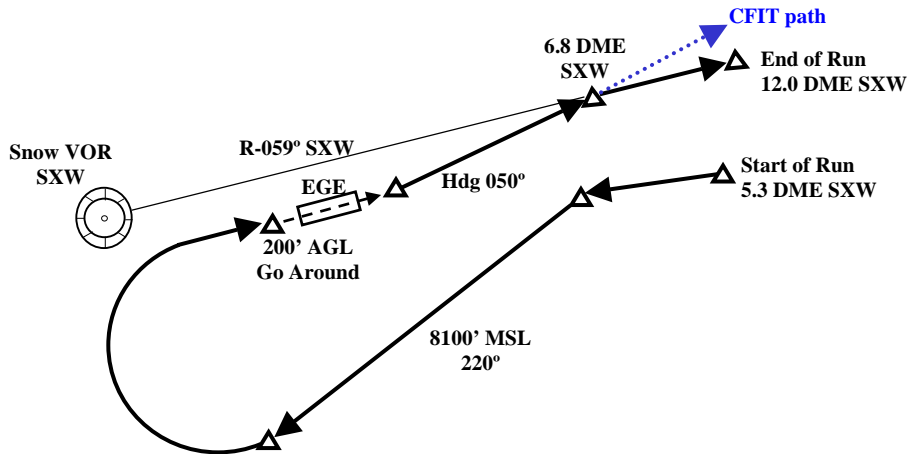

Figure 4. Map view of the approach and departure (go around) task flown by the subject pilot.

Display Conditions

The subjects flew the same approach-departure task with three replications of each of the seven varying display presentations for a total of twenty-one data runs. The display variations were based on four tactical display types (Figure 5; baseline EADI, Size A (5" x 5.25") SVS EADI, Size X SVS PFD, SVS HUD) and terrain texturing type (photo-realistic or generic). For all display presentations, the ND with TAWS and VSD was on a size B (4" x 6") display. A Radio Magnetic Indicator (RMI) showing off path position for the Snow 059 degree radial (SXW R-059), for use during the final part of the departure path, was also provided for all display presentations. For the SVS HUD display condition, the HDD was the baseline (EADI, TAWS and VSD enhanced ND) concept. The tactical display variations (Appendix C, Figures 35 – 41 presents all of the different display types) were:

1. Baseline Size A (5" x 5.25") EFIS 757 EADI display
2. Size A SVS EADI display with color generic textured terrain
3. Size A SVS EADI display with color photo-realistic textured terrain
4. Size X (8"x10") SVS PFD with color generic textured terrain
5. Size X SVS PFD with color photo-realistic textured terrain
6. HUD (24 degree x 18 degree FOV) enhanced with SVS monochrome green generic textured terrain
7. HUD enhanced with SVS monochrome green photo-realistic textured terrain

The final run was a 'rare-event' scenario where the flight guidance directed the airplane into a mountain peak. The display type for the final run (Table 3) was varied across all sixteen test subjects. For the SVS displays

on the final run, only the photo-realistic database was used. Thus only four display variations were tested, with four replicates each.

Table 3. Display type variation for the ‘rare-event’ CFIT data run

Number of subjects	Display type for CFIT data run
4	Baseline EADI with TAWS and VSD enhanced ND, and with a RMI
4	Size A EADI with color photo-realistic textured terrain, with TAWS and VSD enhanced ND, and with an RMI
4	Size X PFD with color photo-realistic textured terrain, with TAWS and VSD enhanced ND, and with an RMI
4	HUD with monochrome photo-realistic textured terrain, with TAWS and VSD enhanced ND, and with an RMI
Total 16 subjects	

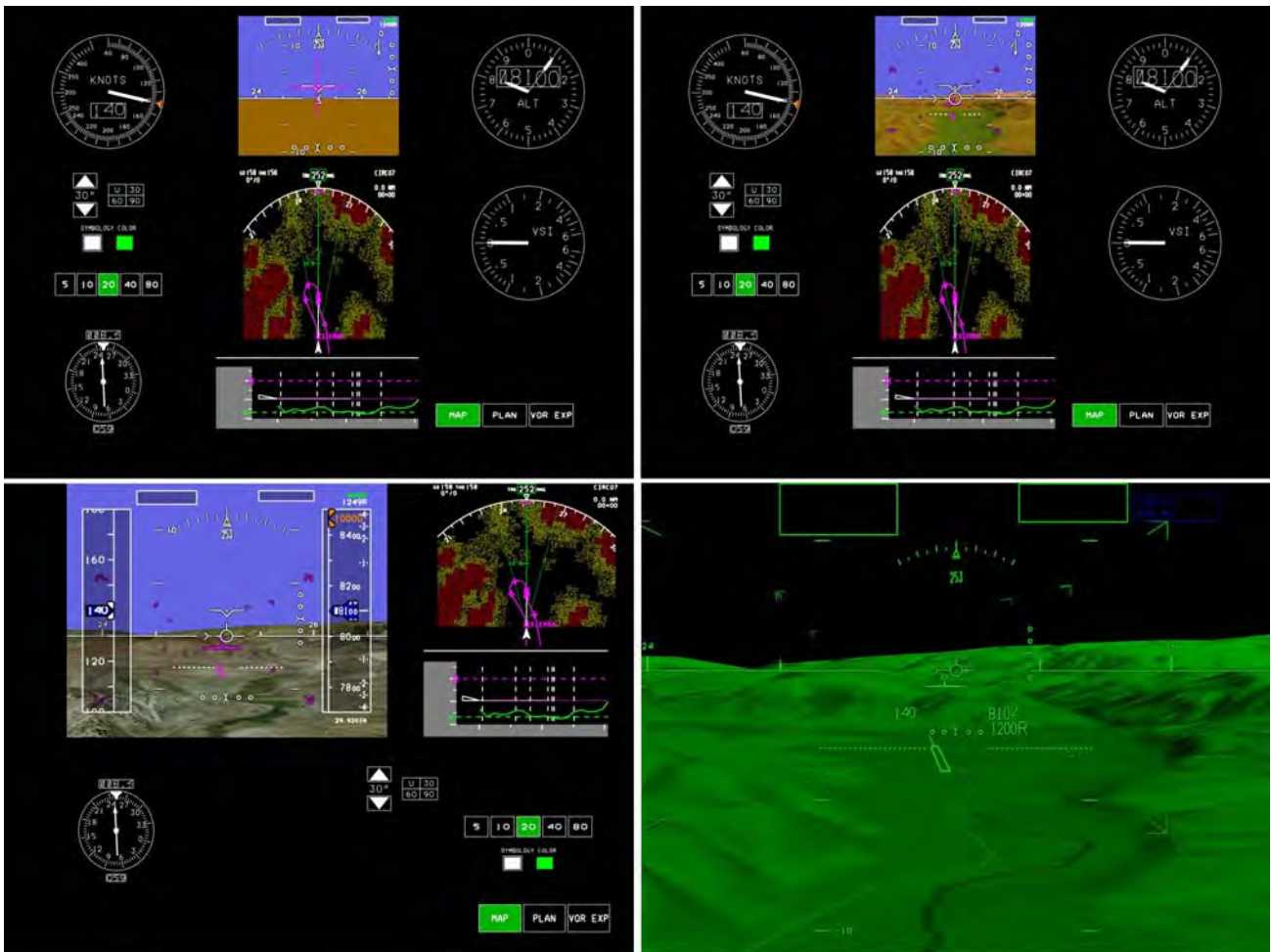

Note that the HUD head down display was the baseline (top left). Examples of generic texturing are shown on the top and bottom right displays, while the bottom left display shows photo-realistic texturing.

Figure 5. Display type Variations: Baseline (top left), Size A (top right), Size X (bottom left) and HUD (bottom right).

Experiment Matrix

Table 4. Experiment data run matrix; three replications for each condition

Repetitions per pilot	Photo textured terrain	Generic textured terrain
Size A	3	3
Size X	3	3
HUD	3	3

In addition to the 18 SVS data runs indicated above in Table 4, each pilot flew three EFIS baseline runs and a final CFIT run. Other than the last run being the ‘rare-event’ CFIT, the data runs were randomized for each pilot.

For the final data run of the experiment session, a ‘rare-event’ CFIT scenario was presented to the subject pilot. The FMS was set such that the flight path and associated flight directors provided guidance into the terrain (dotted line path in Figure 4). The pilots were not briefed that the final run was any different than previous runs. In addition, the subjects were verbally instructed to fly the simulator as if it was an actual airplane with passengers on board and that they should take any necessary action to avoid the terrain. Information sources available to the pilot for potential detection of the anomaly included the TAWS and VSD terrain depictions, and a RMI showing off path position from the same path they had already flown twenty one times before (three times with the baseline). Twelve of the sixteen subject pilots also had terrain information on the SVS HDD (size A or X) or HUD. The photo-realistic textured database was used for all of the SVS ‘rare-event’ data runs.

Measures

Root mean square (RMS) metrics were computed from the measures for vertical and lateral deviations of the simulated B-757 from the defined approach path, and for lateral deviations from the defined departure path, along with speed error for the speed-on-pitch departure task. Pilots were asked structured questions after each run, and at the end of the day, a semi-structured interview was conducted, along with a Situation Awareness – Subjective Workload Dominance (SA-SWORD) questionnaire (Vidulich & Hughes, 1991). Additionally, subjects were given a “take home” questionnaire that was to be mailed back (all responses are in Appendix G).

The approach and departure paths for the task were analyzed using a flight segment analysis approach (see Figure 6 and Table 5). Flight segments were used since the segments contain well-defined piloting tasks in which specific and clear performance expectations were given to the pilots, and control of statistical variability could thus be anticipated. FTE computations (which are one component of RNP calculations) were made from the recorded quantitative path error data for the task. These data were analyzed over the entire approach and departure path (all segments) using histogram analyses (Appendix C, Figures 46 – 49). For lateral path performance, the bin width definitions used were 0.05 nmi. For vertical path performance, the bin width definitions used were 50 feet. The number of occurrences in each bin was totaled and the total number of occurrences divided this total bin value over the entire approach or departure to determine the percentage of occurrences for each bin to form the histograms.

For the rare-event CFIT data runs, impact or close proximity (within 100 feet) of the terrain was the main measure. For cases where the CFIT was detected, the distance from the SXW VOR, where the pilot noticed the potential CFIT, was recorded. The distance measure was converted to ‘time to impact’ based on distance to the impact point and ground speed. In addition, subjects were asked CFIT specific questions in the semi-structured interview.

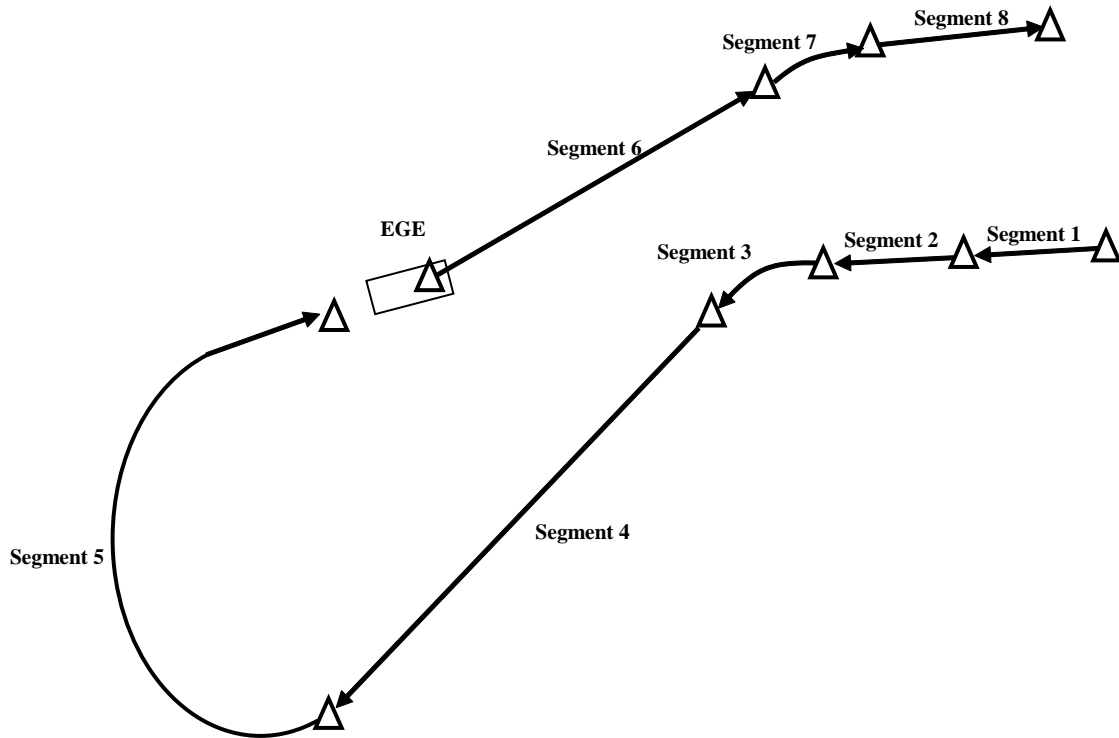

Figure 6. Segmentation of subject task for statistical analysis.

Table 5. Flight Segment Definitions

Segment #	Task	Starting Point	Ending Point
1	Straight 4.43 degree descent	5.3 DME SXW	4.5 DME SXW
2	Halt descent at 8100 ft MSL	4.5 DME SXW	4.0 DME SXW
3	turn left to 220 degrees at 4.0 DME; maintain 8100 ft MSL	4.0 DME SXW	Heading 220 degrees
4	Straight & level at 8100 ft	9.2 nmi along path from touchdown zone of runway 7	4.5 nmi from start of segment
5	Continuous right turn and 3.0 degree descent	4.7 nmi along path from touchdown zone of runway 7	200 ft AGL
Between 5 & 6	Subject over-flies runway, reconfigures airplane, establishes straight 50 degree heading at 140 knots; maintain climb with speed-on-pitch	Missed approach at 200 ft AGL	6000 ft from runway 7 threshold
6	Straight 50 degree heading at 140 knots; maintain climb with speed-on-pitch	6000 ft from runway 7 threshold	DME 6.8 SXW
7	Turn on to 059 degree radial from SXW	DME 6.8 SXW	On 059 radial of SXW
8	Straight 59 degree heading at 140 knots; maintain climb with speed-on-pitch	End of turn of segment 7	12.0 DME SXW

Results

Results from this experiment are presented for quantitative and qualitative data. Analyses of the rare-event CFIT data runs are presented first, followed by the pilot performance data, then the RNP-type data analyses, and finally the qualitative results are discussed. Data analysis of the quantitative path data (RMS vertical and lateral deviation) and speed maintenance (where appropriate) were done for the entire approach and the entire departure task, and by Task Segments for segments of moderate length (segments 1, 2, 3, and 7 were considered to be short transitions with potential for considerable statistical variability and thus were not analysed individually). The data were analyzed by univariate Analysis of Variance (ANOVA) across Subject, Display Type, and, where appropriate, Texture Type (SVS-only Display Types). Student-Newman-Keuls (SNK) tests (at a 5-percent significance level) of individual means were performed at appropriate stages in the analyses. Analyses of pilot performance data are presented first for the entire flight phase of the experiment, and then by individual segments, for both approach and the departure tasks.

Quantitative Results

The quantitative results presented are from statistical analyses of path and speed error performances (where appropriate). All analyses were conducted as full factorial within subject designs, and as expected for a precision task, the main effect of pilot variability was always highly significant for all measures. Only the statistically significant results of the other factors and second order interactions of interest are discussed.

Rare Event CFIT Data Run

For the CFIT scenario, twelve of the sixteen test subjects flew the CFIT scenario with an SVS enhanced PFD (four pilots with Size A, four pilots with Size X) or HUD (four pilots). All twelve pilots with the SVS display detected and avoided the potential CFIT. On average, pilots with an SVS display noticed the potential CFIT 53.6 seconds (the standard deviation was 19.1 seconds) before impact with the terrain. Four of the sixteen pilots flew the CFIT scenario with the baseline display and all four pilots had a CFIT event. Three of the four pilots impacted the terrain while one passed within 58 feet of a mountain peak without awareness of any terrain separation problem. Even though the baseline concept had a TAWS and VSD enhanced ND, and an RMI, none of the subjects were aware of a CFIT event based on either the pilots' maneuvers or post-run elicited comments.

Figure 7 shows four snapshots taken at the same point in time for four Size A displays. The snapshots were taken on departure at 10.1 DME from SXW. The left two displays show the nominal departure and the right two displays show the CFIT departure. The SVS displays clearly show the surrounding terrain while the baseline EADI display provides no terrain awareness. Figure 8 shows the TAWS, VSD and RMI displays (which were common for all display concepts) at the same 10.1 DME point from SXW for the nominal (left) and CFIT (right) runs. The range shown for both the ND and the VSD is 20 nmi. For nominal runs, the departure task was aimed at a notch between two mountain peaks that could be seen on the SVS PFD. Because of the low resolution of the TAWS terrain database, the nominal TAWS showed a terrain warning (solid red, terrain impact within 30 seconds) over the notch region. The TAWS display correctly showed solid red for the CFIT scenario; however, the CFIT TAWS display is very similar in appearance to the nominal TAWS. The RMI was tuned to the 059 radial for SXW, and as seen in Figure 8, there is little difference between the nominal and CFIT RMI reading. Thus for the baseline display configuration, the display elements discussed so far provide few differences between the nominal and CFIT scenarios. However, the VSD information content is quite different. The peak shown on the VSD for the nominal run (left display of Figure 8) is 10 nmi (over four minutes) away; however, the run ends 1.9 nmi (at 12 DME from

SXW) from the present point, and so that peak is of no concern within the scenario. The VSD for the CFIT scenario (right display of Figure 8) clearly shows an imminent CFIT event (1 nmi, 26 seconds to impact).

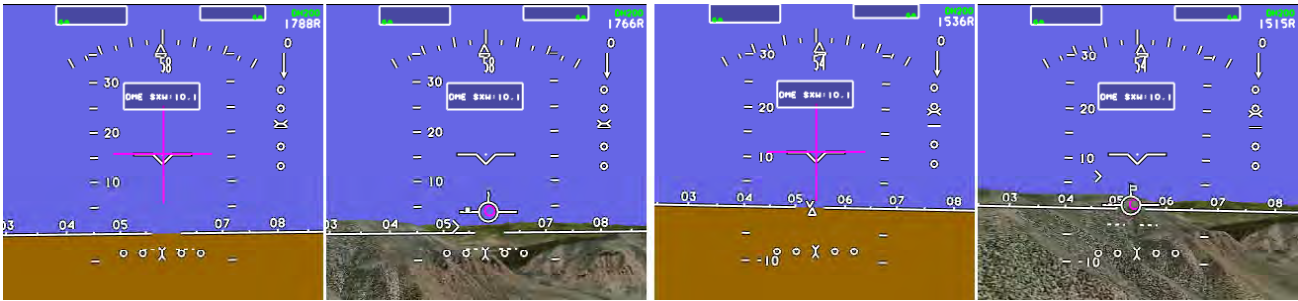

Figure 7. Baseline and SVS displays for nominal run (two left) and baseline and SVS displays for CFIT run (two right)

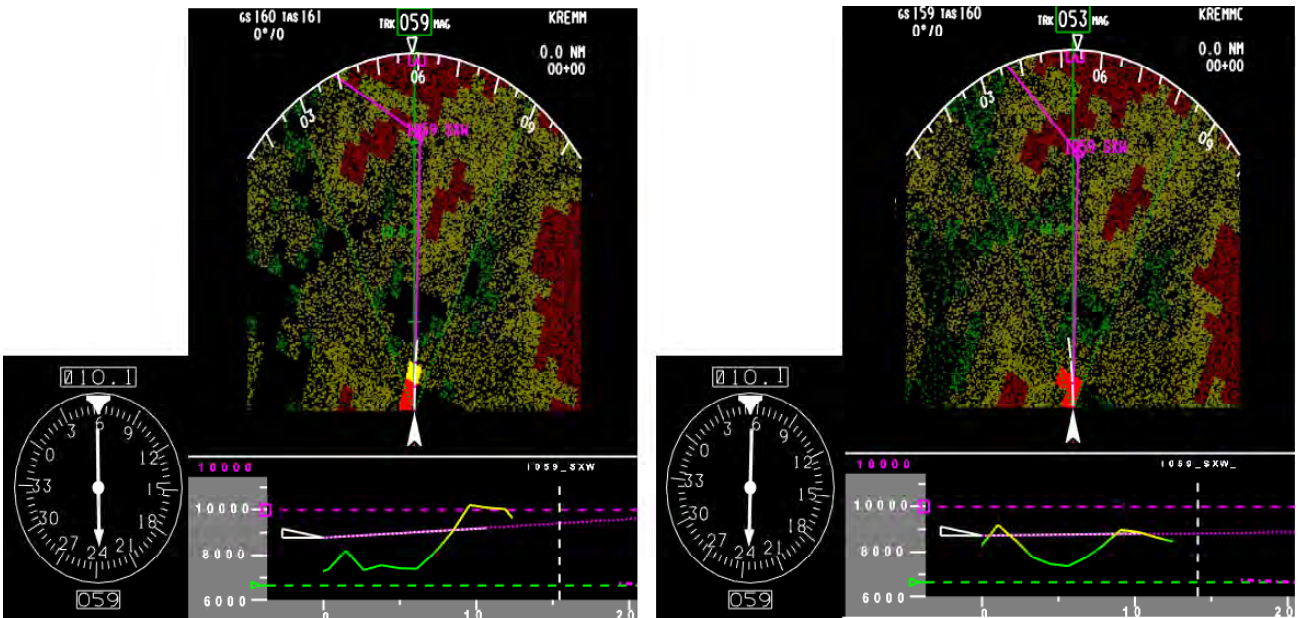

Figure 8. TAWS, VSD and RMI for nominal run (left) and CFIT run (right)

Aside from the rare event CFIT scenario, it should be noted that two CFIT's occurred during nominal data runs (i.e., ground impact short of the runway during nominal circling maneuvers in segment 5). Both unplanned CFIT's occurred with the baseline display during the turn to final for two subjects, each during their first data runs with the baseline concept (note that the subject training included the baseline concept flying this task). With the baseline concept, a CFIT does not affect the simulator in any way; that is, the airplane continues to fly with no effects on its flight path. One of the unplanned CFIT's was clearly a statistical outlier, which would increase the statistical variability enormously and was therefore excluded from the analysis. The second unplanned CFIT occurred because the turn to final was overshoot somewhat and resulted in terrain collision with Snow mountain. However, the subject, unaware of the CFIT event, was able to quickly correct the overshoot and continue the data run, and the RMS path error results were not atypical of baseline concept performances.

Inferences from the rare event CFIT Quantitative Results

All of the subjects with an SVS display avoided the departure CFIT scenario. Subjects commented that they knew “something was wrong” from the presentation of the terrain on the PFD. It was clear on the SVS display that the velocity vector was overlaying vertical terrain directly in the path of the airplane, indicating an imminent terrain collision. Upon noticing a problem on the SVS PFD, most subjects crosschecked with the VSD to confirm there was a terrain collision imminent, and concluded that the guidance was erroneous. In addition, having 3-D perspective terrain gave awareness to the pilot for strategic escape maneuvering. The SVS displays gave subjects an intuitive view of the terrain, which is the theoretical basis for SVS CFIT prevention. As one subject stated, “Pilots don’t fly into mountains they can see.”

Subjects who flew the CFIT scenario with the baseline concept, which included a TAWS and VSD enhanced ND, all had a CFIT event. For the baseline CFIT runs, the TAWS was very similar to the nominal runs which had annunciated warnings for all data runs. The CFIT path was offset by approximately 1 degree from the nominal run. The resulting erroneous indication on the RMI was not noticed by the subjects. The baseline EADI provides no terrain awareness; therefore the only indication of a terrain collision was on the VSD. This finding implies that in order for a VSD to aid in the prevention of a CFIT, sufficient training would be necessary so that pilots would always include the VSD in their scan.

Entire Approach

Baseline/SVS Displays - Analyses of variance were conducted on the main factors of Pilot and Display Type (baseline, Size A, Size X, HUD) for the path error performance measures with the following results:

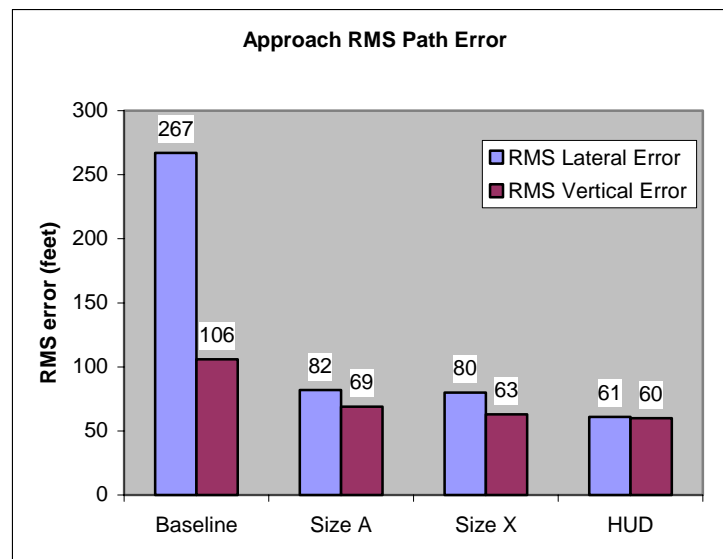

Figure 9. Entire approach path performance errors for display concepts without texturing effects.

RMS lateral approach path error results (Figure 9) - Display Type ($F(3,331)=98.754$, $p<.001$) was highly significant for the measure of RMS lateral path error during the entire approach. Post hoc tests (using Student-Newman-Keuls, SNK, with $\alpha=.05$) showed that with the baseline concept (mean=267 ft), significantly poorer tracking of the lateral path was obtained as compared to the three SVS concepts: Size A (mean=82 ft), Size X (mean=80 ft) and HUD (mean=61 ft). The comparison between the SVS concepts is

presented in the SVS Displays/Texture analysis below (the latter analysis has more statistical power to discriminate differences because the error term, even with fewer degrees of freedom, is so much smaller).

RMS vertical approach path error results (Figure 9) - Display Type ($F(3,331)=5.789$, $p<.001$) was highly significant for the measure of RMS vertical path error during the entire approach. Post hoc test (using SNK with $\alpha=.05$) showed that with the baseline concept (mean=106 ft), significantly poorer tracking of the vertical path was obtained as compared to the three SVS concepts: Size A (mean=69 ft), Size X (mean=63 ft) and HUD (mean=60 ft). The comparison between the SVS concepts is presented in the SVS Displays/Texture analysis below (the latter analysis has more statistical power to discriminate differences).

SVS Displays/Texture - SVS-only Analyses of variance were conducted on the main factors of Pilot, SVS Display Type (Size A, Size X and HUD) and Texture Type for the path error performance measures with the following results:

RMS lateral approach path error results (Figure 9) - SVS Display Type ($F(2,279)=14.208$, $p<.001$) was highly significant for the measure of RMS lateral path error during the entire approach. Post hoc tests (using SNK with $\alpha=.05$) showed that performance with the HUD (mean=61 ft) was statistically better than with Size A (mean=82 ft) and Size X (mean=80 ft). The differences between Size A and Size X could not be discriminated. The improved performance was attributed to the HUD's unity magnification factor, but the performance differences were not considered operationally significant for the entire approach maneuver measure. Neither terrain Texture Type nor the interaction between Display Type and Texture Type were significant for this measure.

RMS vertical approach path error results (Figure 9) - SVS Display Type ($F(2,279)=4.660$, $p<.010$) was highly significant for the measure of RMS vertical path error during the entire approach. Post hoc tests (using SNK with $\alpha=.05$) showed that with the Size A (mean=69 ft) concept, significantly poorer tracking of the vertical path was obtained as compared to the other two SVS concepts: Size X (mean=63 ft) and HUD (mean=60 ft). The differences between Size X and the HUD could not be discriminated. The decreased performance was attributed to the increased minification factor of the Size A display, although the effect was not considered to be operationally significant for the entire approach maneuver measure. Neither terrain Texture Type nor the interaction between Display Type and Texture Type were significant for this measure.

Entire Departure

Baseline/SVS Displays - Analyses of variance were conducted on the main factors of Pilot and Display Type (baseline, Size A, Size X, HUD) for the lateral path error and speed-on-pitch performance measures with the following results:

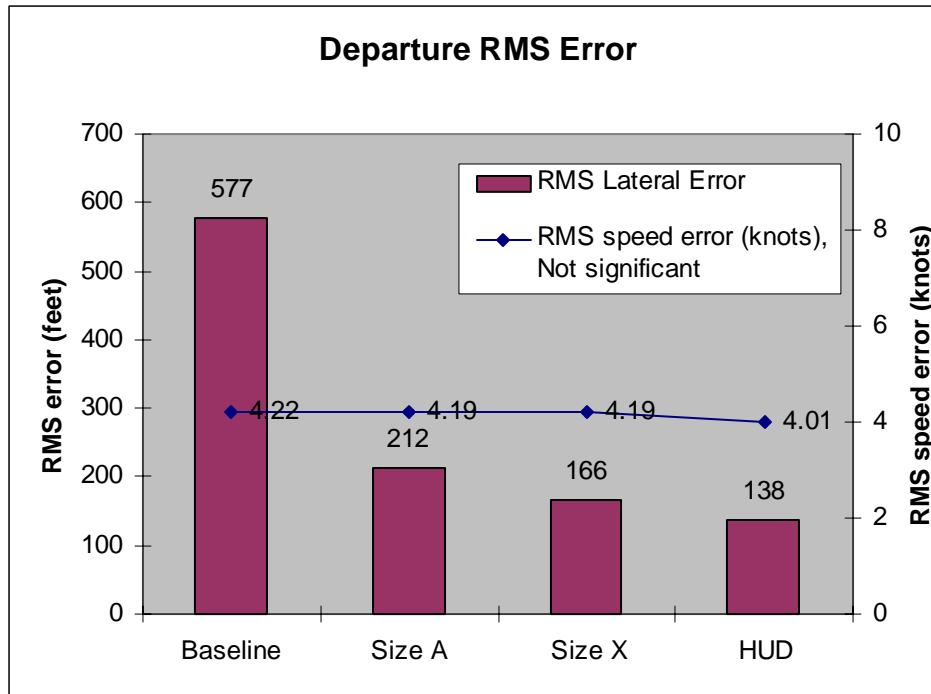

Figure 10. Entire departure path performance errors for display concepts without texturing effects.

RMS lateral departure path error results (Figure 10) - Display Type ($F(3,331)=34.008$, $p<.001$) was highly significant for the measure of RMS lateral path error during the departure. Post hoc tests (using SNK with $\alpha=.05$) showed that with the baseline concept (mean=577 ft), significantly poorer tracking of the lateral path was obtained as compared to the three SVS concepts: Size A (mean=212 ft), Size X (mean=166 ft) and HUD (mean=138 ft). The comparison between the SVS concepts is presented in the SVS Displays/Texture analysis below.

RMS speed-on-pitch error results –Display Type ($F(3,331)=.164$, $p>.05$) was not significant as measured over the entire departure task.

SVS Displays/Texture - SVS-only Analyses of variance were conducted on the main factors of Pilot, SVS Display Type (Size A, Size X, HUD) and Texture Type for the error performance measures with the following results:

RMS lateral departure path error results (Figure 10) - SVS Display Type ($F(2,279)=3.629$, $p<.028$) was significant for the measure of RMS lateral path error as measured over the entire departure task. Post hoc tests (using SNK with $\alpha=.05$), showed that with the HUD concept (mean=138 ft), significantly better tracking of the lateral path was obtained as compared to the Size A concept (mean=212 ft), but no appreciable differences were detectable with the Size X concept (mean=166 ft). Two distinct, overlapping subsets were formed: 1) HUD and Size X, and 2) Size X and Size A. In addition, there were no significant differences between Size A and Size X tracking performances. Although SVS Display Type was statistically significant for RMS lateral path error during the departure, it was not considered to be particularly meaningful operationally for an entire departure task. Performance differences varied directly with the display minification factor (at FOV= 60 degrees, minification factors were: A, 5.0; X, 2.6; HUD, 1.0), with the best performance occurring with the conformal HUD. Neither terrain Texture Type nor the interaction between Display Type and Texture Type were significant for this measure.

RMS speed-on-pitch error results –Display Type ($F(2,279)=.187, p>.05$), Texture Type ($F(1,279)=.012, p>.05$) and the interaction between Display Type and Texture Type ($F(2,279)=.491, p>.05$) were not significant for this measure over the entire departure task.

Segment Analysis

Baseline/SVS Displays – Segment analyses of variance were conducted on the main factors of Pilot and Display Type (baseline, Size A, Size X, HUD) for the individual segments of the approach and departure tasks for lateral and vertical path error and speed-on-pitch performance measures. Analysis of the data in segments 1, 2, 3 and segment 7 was not performed due to the small time spent in each segment (approximately 20 seconds or less for each segment). Note that the data in these excluded segments were included in the analysis presented above for the entire approach and departure.

Approach Segment 4 – Straight and level at 8100 feet MSL

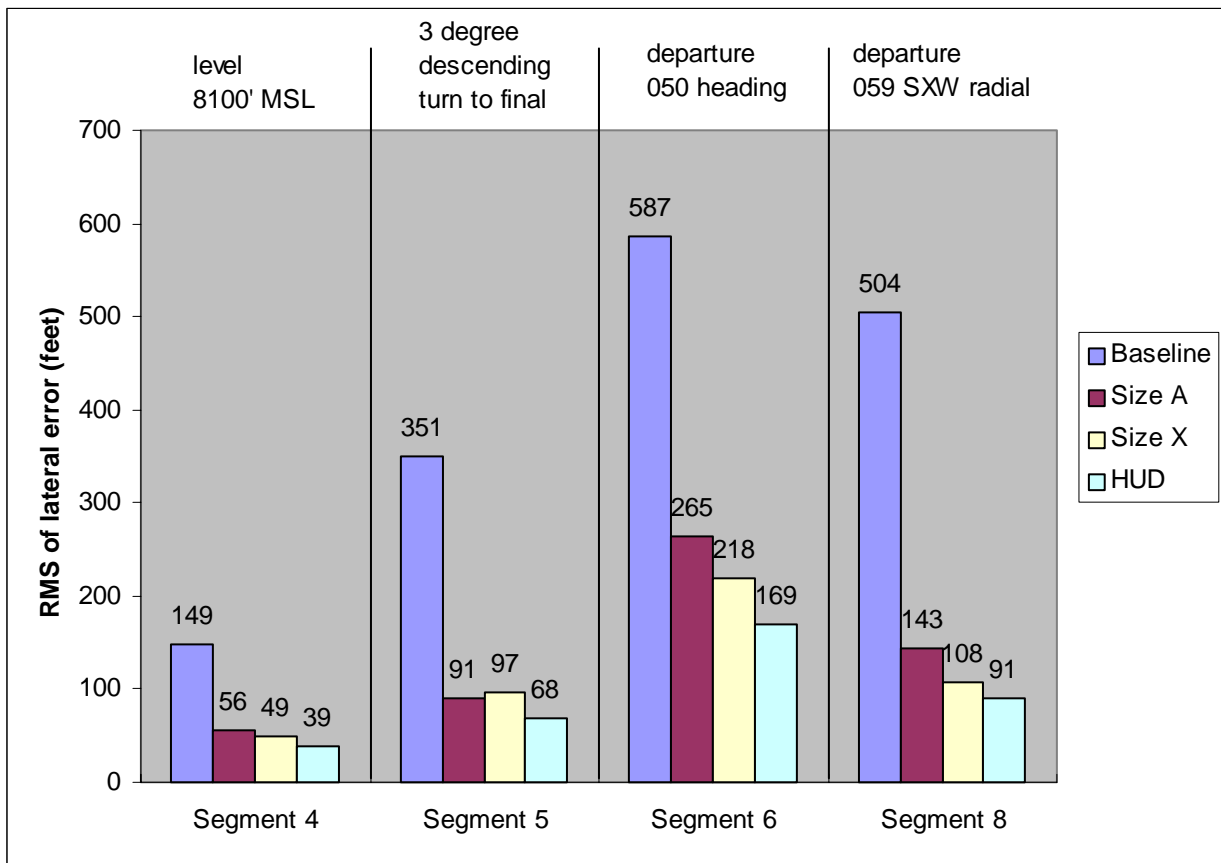

Figure 11. Lateral RMS errors for all pilots by task segment.

RMS lateral path error results (Figure 11) - Display Type ($F(3,331)=57.656, p<.001$) was highly significant for the measure of RMS lateral path error during segment 4. Post hoc tests (using SNK with $\alpha=.05$) showed that the baseline concept (mean=149 ft) produced significantly poorer tracking of the lateral path as compared to the three SVS concepts: Size A (mean=56 ft), Size X (mean=49 ft) and HUD (mean=39ft). There were no significant differences among the SVS concepts for this measure, although differences were

found in the SVS Displays/Texture analysis below (the latter analysis has more statistical power to discriminate differences).

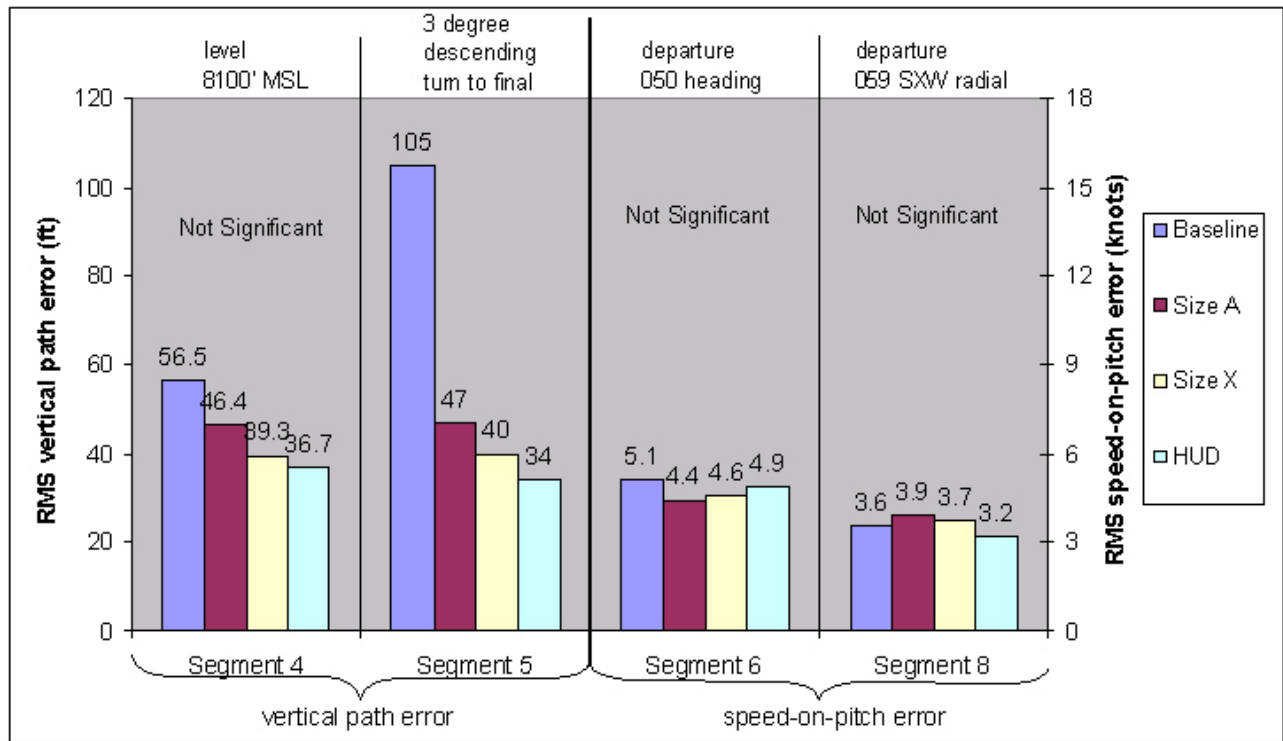

Figure 12. Vertical RMS error for all pilots.

RMS vertical path error results (Figure 12) - Display Type ($F(3,331)=.816, p<.486$) was not significant for the measure of RMS vertical path error during segment 4.

SVS Displays/Texture – SVS-only Analyses of variance were conducted on the main factors of Pilot, SVS Display Type and Texture Type for the lateral and vertical error performance measures with the following results:

RMS lateral path error results (Figure 11) - SVS Display Type ($F(2,279)=9.168, p<.001$) was significant for the measure of RMS lateral path error during segment 4. Post hoc tests (using SNK with $\alpha=.05$) showed that performance with the HUD (mean=39 ft) was statistically better than Size A (mean=56 ft) and Size X (mean=49 ft). The differences between Size A and Size X could not be discriminated. The improved performance was attributed to the HUD's unity magnification factor, but the performance differences were not considered particularly meaningful operationally for this segment. Neither terrain Texture Type nor the interaction between Display Type and Texture Type were significant for this measure.

RMS vertical path error results (Figure 12) –SVS Display Type ($F(2,279)=5.683, p<.004$) was significant for the measure of RMS vertical path error during segment 4. Post hoc tests (using SNK with $\alpha=.05$) showed that with the Size A concept (mean=46 ft), significantly poorer tracking of the vertical path was obtained as compared to the other two SVS concepts: Size X (mean=39 ft) and HUD (mean=37 ft). The differences between Size X and the HUD could not be discriminated. The decreased performance was attributed to the increased minification factor of the Size A display, although the effect was not considered to be particularly

meaningful operationally for this segment. Neither terrain Texture Type nor the interaction between Display Type and Texture Type were significant for this measure.

Approach Segment 5 – 3 degree descending turn to final

RMS lateral path error results (Figure 11) - Display Type ($F(3,331)=60.864$, $p<.001$) was highly significant for the measure of RMS lateral path error during segment 5. Post hoc tests (using SNK with $\alpha=.05$), showed that the baseline concept (mean=351 ft) produced significantly poorer tracking of the lateral path as compared to the three SVS concepts: Size A (mean=91 ft), Size X (mean=97 ft) and HUD (mean=68 ft). There were no significant differences among the SVS concepts for this measure, although differences were found in the SVS Displays/Texture analysis below (the latter analysis has more statistical power to discriminate differences).

RMS vertical path error results (Figure 12) - Display Type ($F(3,331)=13.741$, $p<.001$) was highly significant for the measure of RMS vertical path error during segment 5. Post hoc tests (using SNK with $\alpha=.05$), showed that the baseline concept (mean=105 ft) produced significantly poorer tracking of the vertical path as compared to the three SVS concepts: Size A (mean=47 ft), Size X (mean=40 ft) and HUD (mean=34 ft). There were no significant differences among the SVS concepts for this measure, although differences were found in the SVS Displays/Texture analysis below (the latter analysis has more statistical power to discriminate differences).

SVS Displays/Texture – SVS-only Analyses of variance were conducted on the main factors of Pilot, SVS Display Type and Texture Type for the lateral and vertical error performance measures with the following results:

RMS lateral path error results (Figure 11) - SVS Display Type ($F(2,279)=10.105$, $p<.001$) was significant for the measure of RMS lateral path error during segment 5. Post hoc tests (using SNK with $\alpha=.05$) showed that performance with the HUD (mean=68 ft) was statistically better than Size A (mean=91 ft) and Size X (mean=97 ft). The differences between Size A and Size X could not be discriminated. The improved performance was attributed to the HUD's unity magnification factor, but the performance differences were not considered particularly meaningful operationally for this segment because of the limited fidelity of the simulated HUD. Neither terrain Texture Type nor the interaction between Display Type and Texture Type were significant for this measure.

RMS vertical path error results (Figure 12) –SVS Display Type ($F(2,279)=4.143$, $p<.017$) was significant for the measure of RMS vertical path error during segment 5. Post hoc tests (using SNK with $\alpha=.05$) showed that the Size A concept (mean=47 ft) produced significantly poorer tracking of the vertical path as compared to the HUD (mean=34 ft) concept. The differences between Size X (mean=40 ft) and the HUD could not be discriminated as well as the differences between Size X and Size A. The decreased performance was attributed to the increased minification factor of the Size A display, although the effect was not considered to be particularly meaningful operationally for this segment because of the limited fidelity of the simulated HUD. Neither terrain Texture Type nor the interaction between Display Type and Texture Type were significant for this measure.

Departure Segment 6 – 050 degree heading with speed-on-pitch

RMS lateral path error results (Figure 11) - Display Type ($F(3,315)=26.571$, $p<.001$) was highly significant for the measure of RMS lateral path error during segment 6. Post hoc tests (using SNK with $\alpha=.05$), showed that the baseline concept (mean=587 ft) produced significantly poorer tracking of the lateral path as compared to the three SVS Concepts: Size A (mean=265 ft), Size X (mean=218 ft) and HUD (mean=169 ft). There

were no significant differences among the SVS concepts for this measure, although differences were found in the SVS Displays/Texture analysis below (the latter analysis has more statistical power to discriminate differences).

RMS speed-on-pitch error results (Figure 12) - Display Type ($F(3,315)=.901$, $p>.05$) was not significant for the measure of RMS speed-on-pitch error during segment 6.

Other RMS error results - Within the SVS-only analyses, neither terrain Texture Type nor the interaction between Display Type and Texture Type were significant ($p>.05$) for either RMS lateral path error or RMS speed-on-pitch error during segment 6. However Display Type ($F(2,267)=4.738$, $p<.01$) was significant for RMS lateral path error. Post hoc tests (using SNK with $\alpha=.05$) showed that the Size A concept (mean=265 ft) produced significantly poorer tracking of the lateral path as compared to the HUD concept (mean=169 ft). The differences between Size X (mean=218 ft) and the HUD could not be discriminated, nor could the differences between Size X and Size A. The decreased performance was attributed to the increased minification factor of the Size A display, although the effect was not considered to be particularly meaningful operationally for this segment because of the limited fidelity of the simulated HUD.

Departure Segment 8 – 059 Radial from SXW VOR

RMS lateral path error results (Figure 11) - Display Type ($F(3,331)=22.612$, $p<.001$) was highly significant for the measure of RMS lateral path error during segment 8. Post hoc tests (using SNK with $\alpha=.05$), showed that the baseline concept (mean=504 ft) produced significantly poorer tracking of the lateral path as compared to the three SVS concepts: Size A (mean=143 ft), Size X (mean=108 ft) and HUD (mean=91 ft). There were no significant differences among the SVS concepts for this measure.

RMS speed-on-pitch error results (Figure 12) - Display Type ($F(3,315)=.958$, $p>.05$) was not significant for the measure of RMS speed-on-pitch error during segment 8.

Other RMS error results - Within the SVS-only analyses, neither Display Type, terrain Texture Type nor the interaction between Display Type and Texture Type were significant ($p>.05$) for either RMS lateral path error or RMS speed-on-pitch error during segment 8.

Inferences from the Quantitative Results

Approach Path

In almost all of the approach analyses, significantly poorer tracking of both the lateral and vertical paths was obtained with the baseline concept as compared to the three SVS Concepts. While the guidance commands to correct for lateral and vertical path errors during approach were somewhat different, the magnitudes of the differences obtained may not be attributed to that factor alone. In the pre-experiment testing, approximate performance was obtained using both control laws. Improved tracking may be more attributed to the guidance symbology differences - specifically, to the tunnel or pathway and flight path marker symbology versus the conventional attitude flight director symbology. Note that the control law was the same for the departure, yet performance differences were obtained there as well. Similar results have been reported in numerous research studies confirming the advantages of making manual approaches using a tunnel because of the anticipatory nature of the display. Research has long established the benefits of prediction and preview (e.g., Lintern, Roscoe, & Sivier, 1990) and presentation of this information in a 3-D perspective (Haskell & Wickens, 1993; Wickens & Prevelt, 1995; Theunissen, 1997). Therefore, the finding that the SVS guidance consisting of an integrated single cue flight guidance symbol (the ghost airplane on approach) with a tunnel

and velocity vector compared to a baseline concept with no tunnel was not surprising, but did confirm the desirability to include the use of a “pathway-in-the-sky” as an essential element in a synthetic vision system.

Among the three SVS concepts, statistically significant tracking performance effects for both the lateral and vertical paths were not considered to be operationally meaningful. When they did occur, performance differences usually varied directly with the display minification factor, with the best performance occurring with the conformal HUD. Similar results have been reported in the previous SVS flight and simulation tests, and the current results verify the finding that with pilot selectable FOV, effective applications of SVS display technology can be accomplished in aircraft equipped with HDDs as small as Size-A (5.25” wide by 5” tall), thus confirming the potential of these SVS concepts as retrofit candidates for replacing current displays with synthetic vision technology.

Additionally, no significant differences were found for Texture Type or the interaction between Display Type and Texture Type. These results also agree with the previous findings of SVS flight and simulation tests in which no objective measures revealed texture effects.

Departure Path

The lateral path tracking performance results for departure mirrored the approach path results. This finding was something of a surprise, in that, unlike the SVS concepts for approach, no tunnel was presented during the departure task for the SVS concepts. Also, the guidance commands used to drive the guidance symbologies were identical. Thus the only elements available to which the performance differences might be attributed include the dual cue, attitude-based symbology of the baseline concept versus the single cue, flight path marker-based symbology of the SVS concepts, and the fact that the baseline concept would require the pilot to redirect attention to the Navigation Display (TAWS, VSD) to acquire terrain information, while terrain information was present on the SVS tactical display. Either or both potential explanations imply a direct correspondence with workload results for the departure task (i.e., poorer tracking performance because of increased workload demands), which are presented in a later section. While most of the within SVS display concepts comparisons produced no statistically meaningful results, they, too, mirrored the approach path results in that the trends in performance differences always varied directly with the display minification factor, with the best performance occurring with the conformal HUD.

Required Navigation Performance (RNP)

RNP is a statement of the navigation performance accuracy necessary (see Appendix B) for operation within a defined airspace (RTCA DO-236A, 2000). RNP airspace is a generic term referring to airspace, routes, and legs, where minimum navigation performance requirements have been established and aircraft must meet or exceed that performance to fly in that airspace. RNP type is a designator according to navigational performance accuracy in the horizontal plane (lateral and longitudinal position fixing). This designator invokes all of the navigation performance requirements associated with the applicable RNP number, which is a containment value. For example, RNP-1 means that for at least 95% of the time the navigational performance in the horizontal plane, or the total horizontal system error, is less than 1.0 nmi. In addition to requiring 95% positioning accuracy for RNP operations, these types of procedures also require integrity of the positioning accuracy at 99.999% at 2 x RNP number. In our example above with an RNP-1, the position accuracy within 2.0 nmi of the ownship (2 x RNP value of 1.0 nmi) would have to be guaranteed to be correct 99.999% of the time to enable RNP-1 operations. Vertical navigation (VNAV) capability further enhances flight operations by enabling the specification of a flight path vertically for the lateral flight path. VNAV ensures that for at least 99.7% of the time the navigational performance in the vertical plane, or the total vertical system error, is less than a specified altitude deviation measure based on the airspace being flown in

(below 5000 feet MSL, 5000-10000 feet MSL, above 10000 feet MSL) and the type of flight operation (level flight/climb/descent or flight along specified vertical profile) being performed. For the approach-departure task in this experiment, the approach begins at 8200 feet MSL and is never lower than 5000 feet MSL. Therefore, since the pilot was flying a specified vertical profile, the required RNP vertical accuracy was 300 feet.

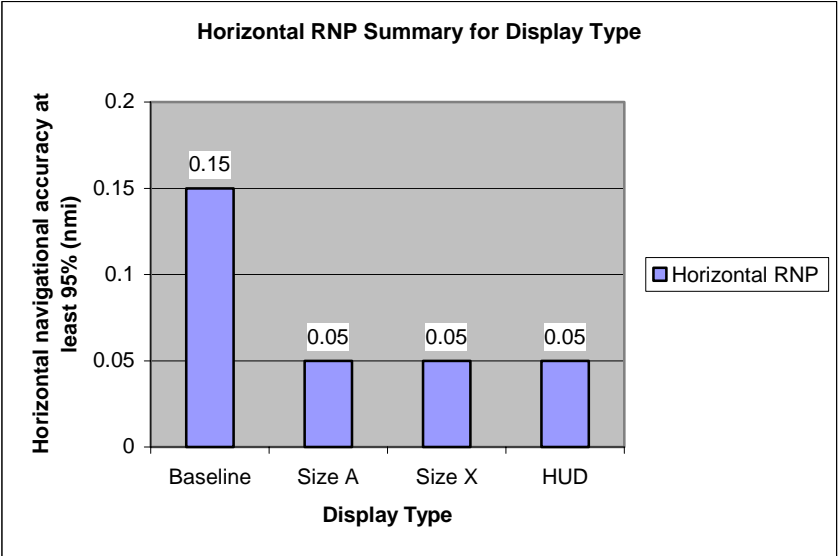

Figure 13. Summary of the approach horizontal RNP for all display types averaged across all subjects.

Figure 13 shows the horizontal FTE distribution for the display concepts using the bin widths of 0.05 nmi for the simulated EGE Visual 07 Approach. The path steering error component of the RNP calculation includes both FTE and display error. For this analysis, display error was assumed to be negligible; therefore FTE was the only component of path steering error. Also assumed for this analysis was that the other two components (path definition error and position estimation error) of the RNP calculation would be equivalent across the display concepts evaluated. The SVS concepts were able to achieve a horizontal FTE navigational accuracy of 0.05 nmi at least 95% of the time; while the baseline concept was able to achieve a horizontal FTE navigational accuracy of 0.15 nmi at least 95% of the time. As such, based on the FTE distributions shown, the SVS concepts (Size A, Size X, HUD) would enable horizontal RNP-type operations that were three times smaller than those that would be allowed with the baseline EADI concept. The complete RNP results can be found in Appendix C in Figures 46 through 49.

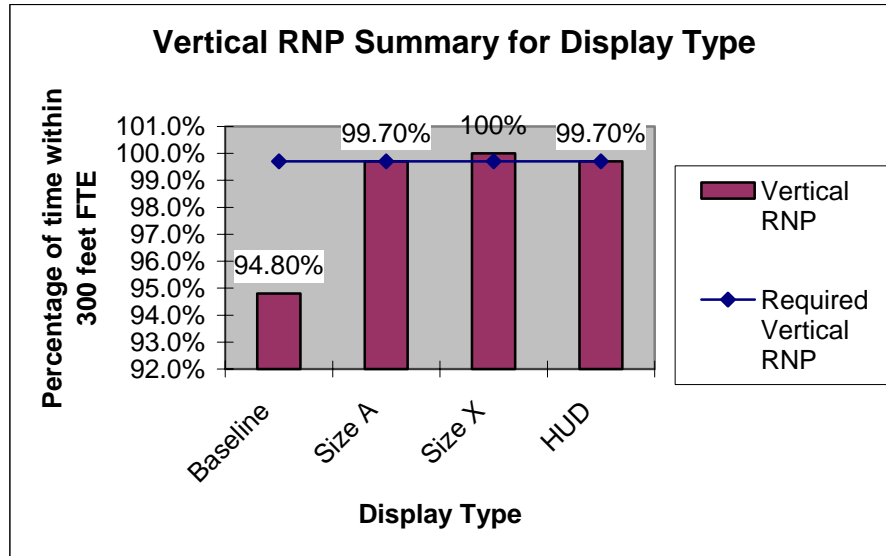

Figure 14. Summary of approach vertical RNP for all display types averaged across all subjects.

Figure 14 shows the vertical FTE distribution for the display concepts using the bin widths of 50 feet. The vertical path steering error component of the vertical navigation (VNAV) performance calculation includes both FTE and display error. For this analysis, display error was assumed to be negligible therefore the FTE was the only component of vertical path steering error. Also assumed for this analysis was that the other three components (altimetry system error, vertical path definition error, and horizontal coupling error) of the VNAV performance calculation would be equivalent across the display concepts evaluated. All SVS concepts (Size A, Size X, and HUD) were able to achieve a vertical FTE navigational accuracy of 300 feet at least 99.7% of the time, while the baseline concept was unable to achieve this required RNP accuracy. As such, based on the FTE distributions shown, the SVS concepts would enhance flight operations by enabling the specification of a flight path vertically for the lateral flight path.

Subjective Results

Pilots were asked structured questions after each run. At the end of the day, a semi-structured interview was conducted along with a SA-SWORD questionnaire (Vidulich & Hughes, 1991). Qualitative results in the form of pilot comments are summarized below:

Post Run Questionnaire Results

After each individual data run, subjects were asked to rate their mental workload for the combined task (both approach and departure) using the Modified Cooper-Harper (MCH) Workload Scale (Boff et al., 1998). A low MCH Workload rating represented a low mental workload task. They were also asked to respond to six statements (See Appendix D). The responses to the statements are reported in the positive sense for ease in data interpretation. For example, one statement used during the experiment was “It was difficult to interpret the guidance cues”; however, in this paper, the results are reported as if the statement were phrased “It was easy to interpret the guidance cues.” Although MCH Workload ratings were solicited, responses to the six statements were not sought after the rare-event runs because they were not relevant.

Modified Cooper-Harper Workload Scale Results for Nominal and Rare Event Runs

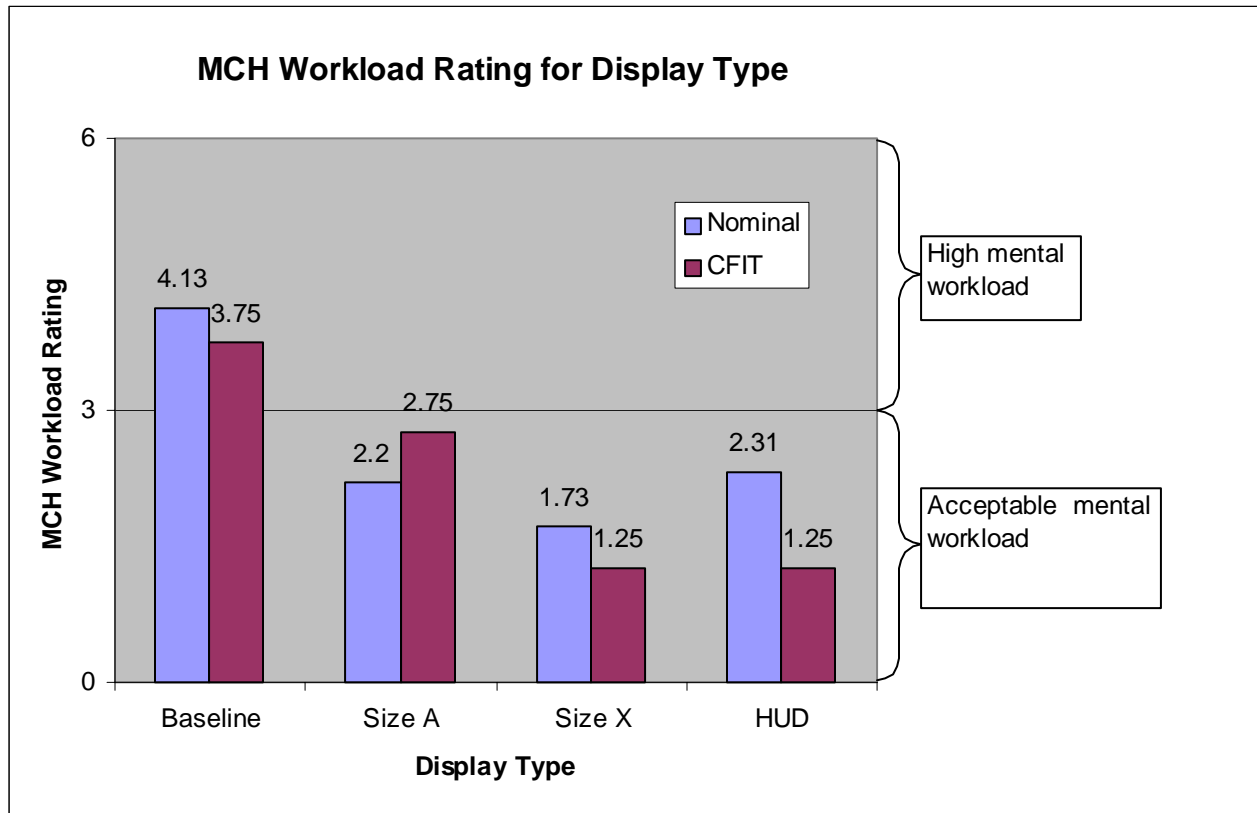

Figure 15. Subject Pilot average MCH Workload ratings for each display type

MCH Workload results for nominal runs (Figure 15) Baseline/SVS Displays - Display Type ($F(3,314)=110.77, p<.001$) was highly significant for the pilots' mental workload (MCH Workload) rating. Post hoc tests (using SNK with $\alpha=.05$) showed that the baseline concept (rating=4.13) with TAWS and VSD enhanced ND increased the pilots' mental workload rating as compared to the three SVS concepts: Size A (rating=2.20), Size X (rating=1.73) and HUD (rating=2.31). The Size X concept taxed the pilots' mental workload less than the other two SVS concepts but this difference was not considered practically significant. Consistent with previous results within the SVS Project, the Size A display is considered less effective because of the increased minification factors entailed by its small size, and the HUD is considered less effective because of its fixed field of regard. But the differences were not considered practically significant. In general, the baseline concept required a moderately high operator mental effort to attain adequate system performance, while the SVS concepts required a low operator mental effort and better performance was obtained.

MCH Workload results for rare event CFIT runs (Figure 15) baseline/SVS Displays - Display Type ($F(3, 15)=10.286, p<.001$) was highly significant for the MCH Workload ratings. Post Hoc tests (using SNK with $\alpha=.05$) indicated two unique subsets: 1) Size X and HUD and 2) Size A and baseline. The HUD concept (mean rating=1.25) and Size X concept (mean rating=1.25) were judged to require less pilot workload (minimal to low operator mental effort) than the Size A concept (mean rating=2.75) and the baseline concept (mean rating=3.75). Although the Size A concept (low to acceptable operator mental effort) had a lower workload rating than the baseline concept, the difference was not statistically differentiable. The rating for

the baseline concept with TAWS and VSD enhanced ND (moderately high operator mental workload) indicated that the mental work level was not acceptable and should be reduced.

MCH Workload results SVS Displays/Texture - The Display Type results from the SVS-only analysis were consistent with the above Baseline/SVS Displays analysis. Terrain Texture Type ($F(1,264)=6.602, p<.011$) was statistically significant (but was not considered to be operationally significant) for the pilot's mental workload rating. The mean rating was 1.98 for the photo-realistic texturing and 2.18 for the generic texturing, both equating to a low operator mental workload requirement. The interaction between SVS Display Type and Texture Type was not significant for this measure.

Post Run Statement Responses for Nominal Runs

Subjects were asked to rate each statement with a value between 1 and 6, where a 1 indicated a strong disagreement with the statement and a 6 represented strong agreement. Ratings of 2 and 5 were moderate disagreement or agreement, respectively, and ratings of 3 and 4 were slightly disagree or agree, respectively.

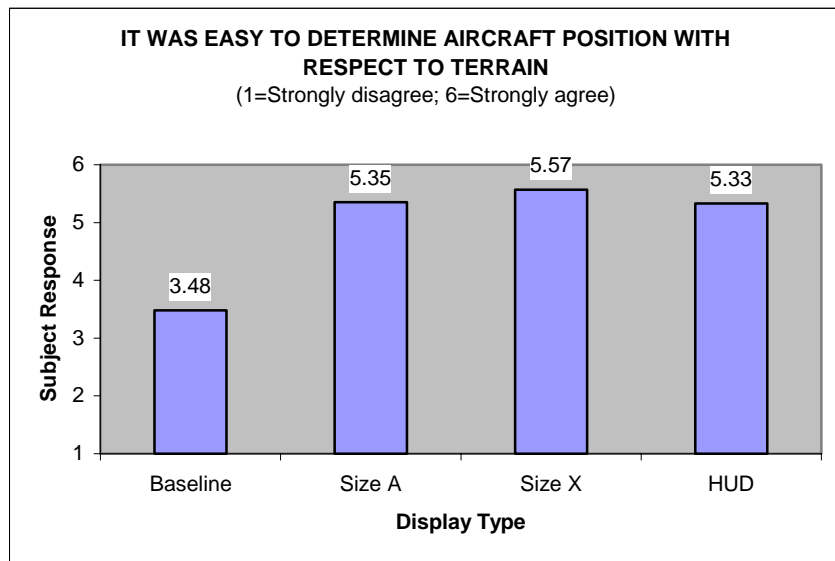

Figure 16. Average results of subjects' responses to run statement 1.

Run Statement 1 (Figure 16) - *It was easy to determine aircraft position with respect to the terrain*: Display Type ($F(3,314)=111.140, p<.001$) was highly significant for the measure of ease of determining aircraft position with respect to terrain. Post hoc tests (using SNK with $\alpha=.05$) showed that it was judged harder to determine aircraft position with respect to terrain with the baseline concept (rating=3.48) with TAWS and VSD enhanced ND than it was with the three SVS concepts: Size A (rating=5.35), Size X (rating=5.57) and HUD (rating=5.33). There were no appreciable differences between the SVS concepts (even within the more powerful SVS-only ANOVA).

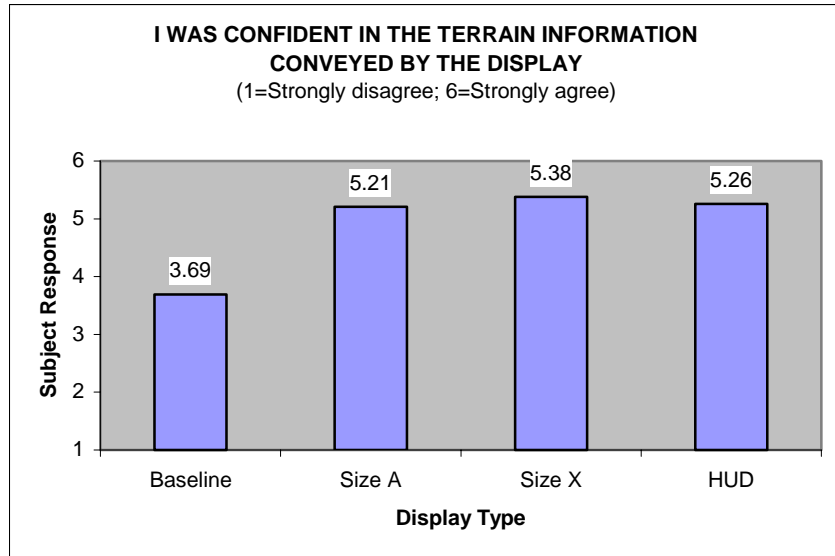

Figure 17. Average results of subjects' responses to run statement 2.

Run Statement 2 (Figure 17) - *I was confident in my knowledge of separation from the terrain*: Display Type ($F(3,314)=79.454, p<.001$) was highly significant for the measure of a pilot's confidence in his knowledge of the aircraft's separation from the terrain. Post hoc tests (using SNK with $\alpha=.05$) showed that the pilots were less confident in the knowledge of terrain clearance with the baseline concept (rating=3.69) with TAWS and VSD enhanced ND than with the three SVS concepts: Size A (rating=5.21), Size X (rating=5.38) and HUD (rating=5.26). There were no appreciable differences between the SVS concepts (even within the more powerful SVS-only ANOVA).

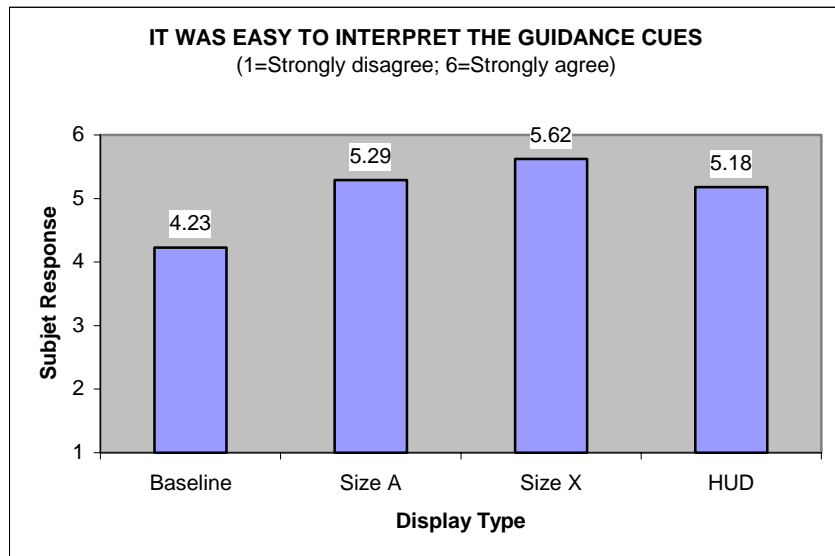

Figure 18. Average results of subjects' responses to run statement 3.

Run Statement 3 (Figure 18) - *It was easy to interpret the guidance cues*: Display Type ($F(3,314)=50.372, p<.001$) was highly significant for the measure of ease of interpreting guidance cues. Post hoc tests (using SNK with $\alpha = .05$) showed that it was judged slightly harder to interpret the guidance cues with the baseline

display concept (dual cue guidance symbol, rating=4.23) than it was with the three SVS display concepts (single cue ball guidance symbol), which were indistinguishable (even within the more powerful SVS-only ANOVA): Size A (rating=5.29), Size X (rating=5.62) and HUD (rating=5.18).

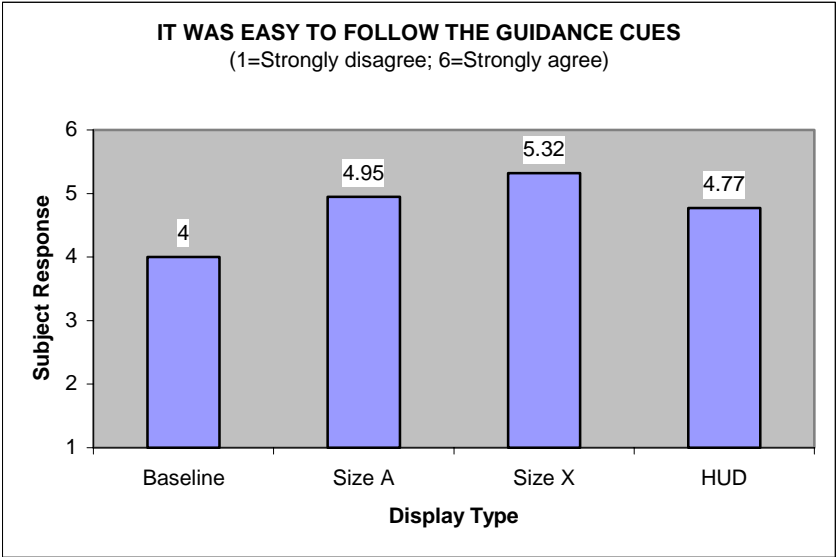

Figure 19. Average results of subjects' responses to run statement 4.

Run Statement 4 (Figure 19) – *It was easy to follow the guidance cues*: Display Type ($F(3,314)=33.717$, $p<.001$) was highly significant for the measure of ease of following the guidance cues. Post hoc tests (using SNK with $\alpha = .05$) showed that it was judged slightly harder to follow the guidance cues with the baseline display concept (dual cue guidance symbol, rating=4.00) than it was with the three SVS display concepts (single cue ball guidance symbol), which were indistinguishable (even within the more powerful SVS-only ANOVA): Size A (rating=4.95), Size X (rating=5.32) and HUD (rating=4.77).

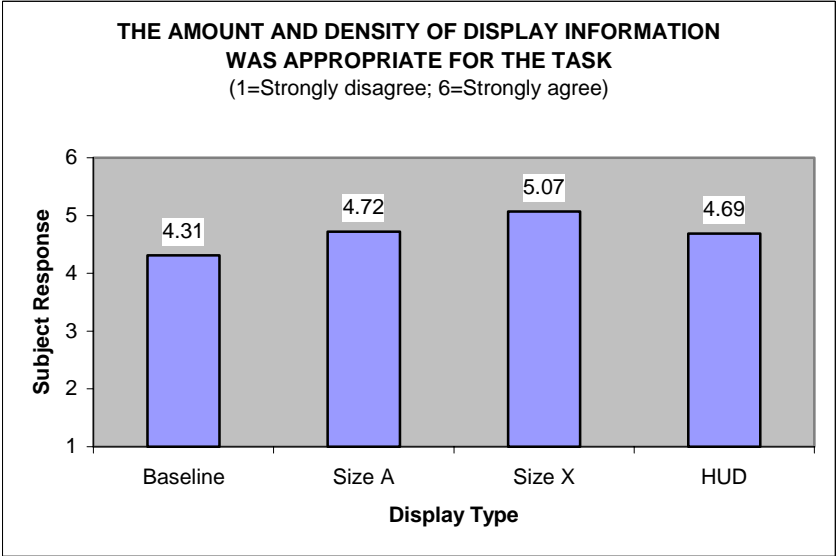

Figure 20. Average results of subjects' responses to run statement 5.

Run Statement 5 (Figure 20) – *The amount and density of display information was appropriate to the task*: Subject pilots were briefed during the training session that this statement referred to amount of clutter on the display. Display Type ($F(3,314)=10.907$, $p<.001$) was highly significant for the measure of interpretability of display information. Post hoc tests (using SNK with $\alpha = .05$) showed that it was judged slightly harder to interpret the display information with the baseline display concept (rating=4.31) than it was with the three SVS display concepts, which were indistinguishable (even within the more powerful SVS-only ANOVA): Size A (rating=4.72), Size X (rating=5.07) and HUD (rating=4.69).

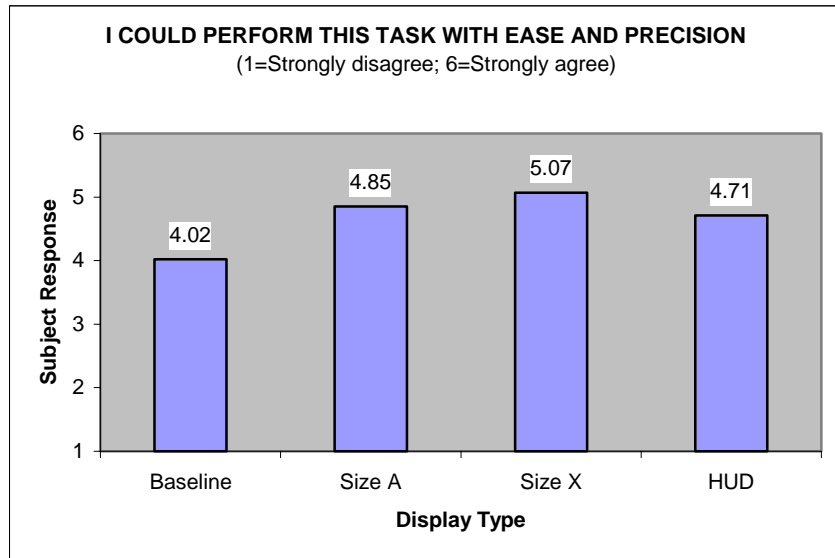

Figure 21. Average results of subjects' responses to run statement 6.

Run Statement 6 (Figure 21) – *I could perform the task with ease and precision*: Display Type ($F(3,314)=19.842$, $p<.001$) was highly significant for the measure of performing the flying task with ease and precision. Post hoc tests (using SNK with $\alpha = .05$) showed that it was judged slightly harder to perform the flying task with the baseline display concept (rating=4.02) than it was with the three SVS display concepts, which were indistinguishable (even within the more powerful SVS-only ANOVA): Size A (rating=4.85), Size X (rating=5.07) and HUD (rating=4.71).

SA-SWORD Questionnaire Results

The SA-SWORD (Vidulich & Hughes, 1991) for this experiment was administered to allow a statistical analysis of the pilot's subjective assessment of the SA for each of the seven Display Configurations (baseline and photo-realistic and generic texturing on Size A, Size X and HUD). The definition of SA was defined as: *The pilot's awareness and understanding of all factors that will contribute to the safe flying of their aircraft under normal and non-normal conditions.*

Display Configuration was highly significant for the SA-SWORD ratings ($F(6,90)=14.443$, $p<0.001$). Post hoc tests (using SNK with $\alpha = .05$) showed that the photo-textured Size X display was judged to provide significantly better SA than all other display concepts tested. The photo-textured HUD was judged to provide significantly better SA than both Size A (generic and photo) concepts and the baseline concept but had no appreciable statistical differences from the generic-textured Size X or generic-textured HUD (Figure 22).

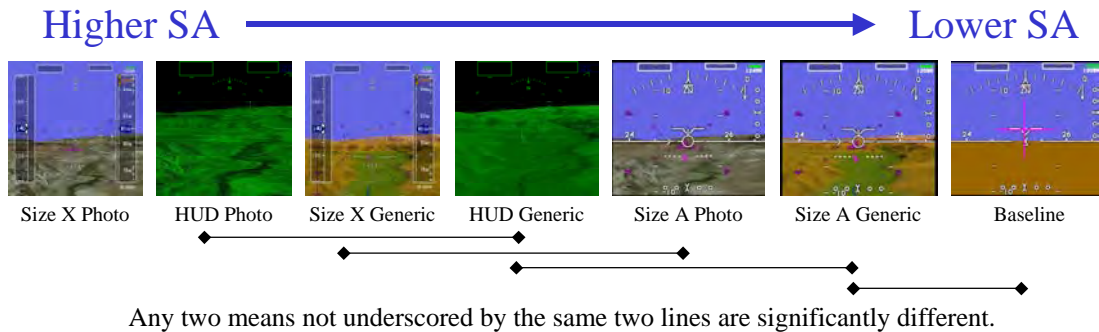

Figure 22. Comparative situational awareness among display concepts.

Among the three types of SVS concepts (Size A, Size X, HUD), statistically the photo-realistic database was judged to afford significantly more SA than generic texturing for the Size-X display concept only. All other texturing effects within a given size were not discriminable.

Pilot Workload Rating Results

The subjects were asked to rate the workload using each display concept (baseline, Size A, Size X and HUD) for both the approach and departure separately. Workload was defined as: “the degree of cognitive processing capacity required to perform the flight task approach adequately”. Figure 23 shows the scale that the pilots used for the workload and SA ratings.

Workload and SA Rating Scale									
1	2	3	4	5	6	7	8	9	
Very High		Somewhat High			Somewhat Low			Very Low	

Figure 23. Workload and SA rating scale.

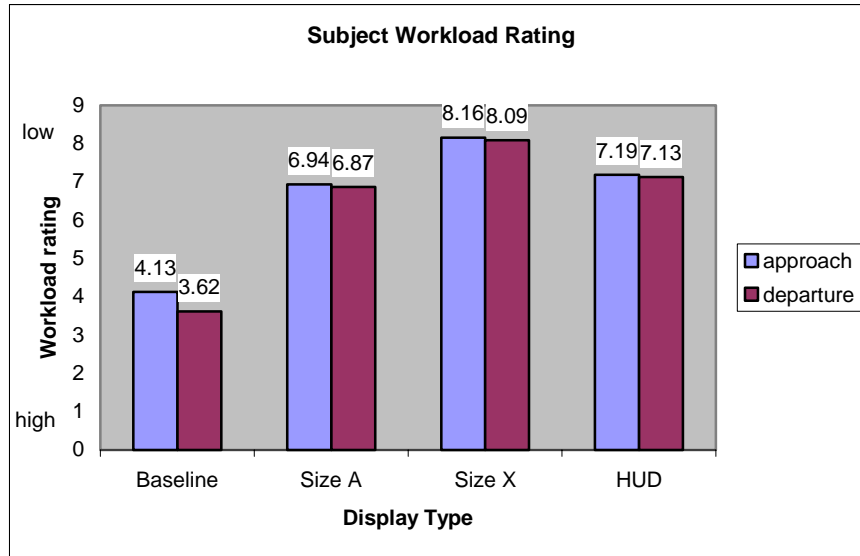

Figure 24. Subjects' rating of their workload for the approach and departure tasks.

Approach Path

Baseline/SVS Displays (Figure 24) - Display Type ($F(3,93)=67.310$, $p<.001$) was highly significant for the measure of pilot workload rating during the approach. Post hoc tests (using SNK with $\alpha = .05$), showed that the baseline concept (rating=4.13) increased the pilots' workload rating as compared to the three SVS concepts: Size A (rating=6.94), Size X (rating=8.16) and HUD (rating=7.19). The Size X concept taxed the pilots' workload less than the other two SVS concepts. Consistent with previous results, the Size A display is considered less effective because of the increased minification factors entailed by its small size, and the HUD is considered less effective because of its fixed field of regard. In general, the baseline concept workload rating was somewhat high and the pilots' workload rating with the SVS concepts was somewhat low during the approach.

SVS displays/texture - The Display Type results from the SVS-only analysis were consistent with the above Baseline/SVS Displays analysis. Neither terrain Texturing Type or the interaction between SVS Display Type and Texture Type was significant for this measure during the approach.

Departure Path

Baseline/SVS Displays (Figure 24) - Display Type ($F(3,93)=93.651$, $p<.001$) was highly significant for the measure of pilot workload rating during the departure. Post hoc tests (using SNK with $\alpha = .05$) showed that the baseline concept (rating=3.62) increased the pilots' workload rating as compared to the three SVS Concepts: Size A (rating=6.87), Size X (rating=8.09) and HUD (rating=7.13). The Size X concept taxed the pilots' workload less than the other two SVS concepts. Consistent with previous results, the Size A display is considered less effective because of the increased minification factors entailed by its small size, and the HUD is considered less effective because of its fixed field of regard. In general, the baseline concept workload rating was somewhat high and the pilots' workload rating with the SVS concepts was somewhat low during the departure.

SVS displays/texture - The Display Type results from the SVS-only analysis were consistent with the above Baseline/SVS Displays analysis. Neither terrain Texturing Type or the interaction between SVS Display Type and Texture Type was significant for this measure during the departure.

Pilot SA Rating Results

Subjects were asked to rate their level of SA experienced during both the approach and departure task separately, for each display concept (See Figure 23 for rating scale). Note that the SA ratings were reversed scored (ie, 9 was very high SA and 1 was very low SA).

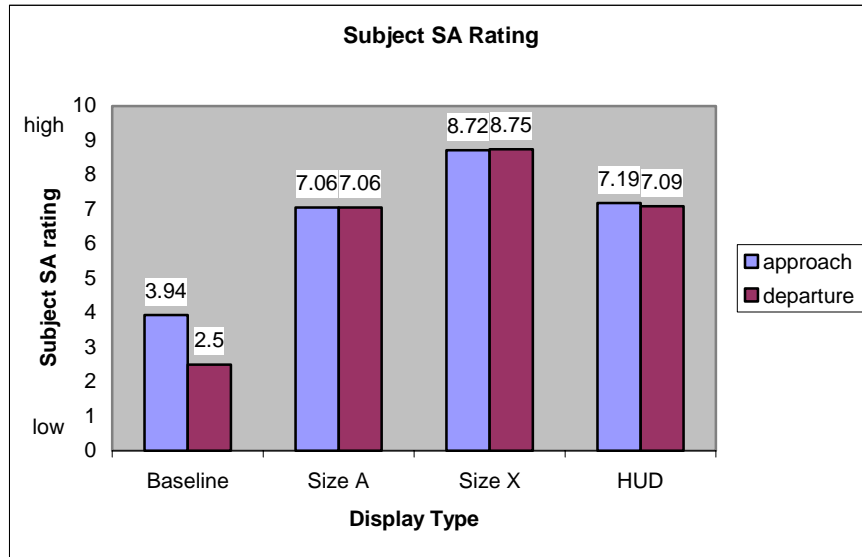

Figure 25. Subjects’ rating of SA for the approach and departure task.

Approach Path

Baseline/SVS Displays (Figure 25) - Display Type ($F(3,93)=154.272, p<.001$) was highly significant for the pilot’s SA rating during the approach. Post hoc tests (using SNK with $\alpha = .05$), showed that the baseline concept (rating=3.94) was judged to have less situation awareness as compared to the three SVS concepts: Size A (rating=7.06), Size X (rating=8.72) and HUD (rating=7.19). The Size X concept was judged to provide better SA than the other two SVS concepts. Consistent with previous results, the Size A display is considered less effective because of the increased minification factors entailed by its small size, and the HUD is considered less effective because of its fixed field of regard. In general, the pilots’ SA with the baseline concept was somewhat low and their SA with the SVS concepts was high during the approach.

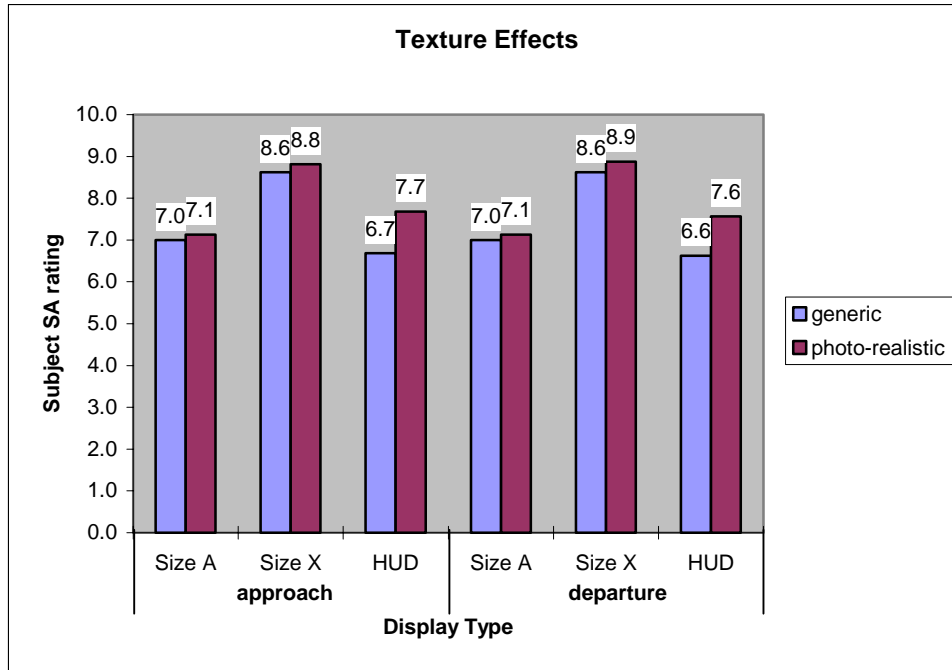

Figure 26. Subjects' rating of SA for Texture Type for the approach and departure task.

SVS displays/texture - The Display Type results from the SVS-only analysis were consistent with the above Baseline/SVS Displays analysis. Terrain Texture ($F(1,75)=11.239$, $p<.001$) and the interaction between SVS Display Type and Texture Type ($F(2,75)=4.664$, $p<.012$) were significant for this measure during approach. The photo-realistic texture (mean = 7.88) obtained a higher mean situation awareness rating for the approach task than did the generic texture (mean = 7.44), but the significant interaction between SVS Display Type and Texture Type (shown in Figure 26) indicated that this effect was only present for the HUD (see Figure 26). The Texture Type effect was negligible for the HDDs. Operationally, these results were considered not significant, as the situation awareness ratings (varying from 6.6 to 8.9) were all high.

Departure Path

Baseline/SVS Displays (Figure 25) - Display Type ($F(3,93)=283.305$, $p<.001$) was highly significant for the pilot's SA rating during the departure. Post hoc tests (using SNK with $\alpha = .05$), showed that the baseline concept (rating=2.50) was judged to have considerably less situation awareness as compared to the three SVS concepts: Size A (rating=7.06), Size X (rating=8.75) and HUD (rating=7.09). The Size X concept yielded better pilot SA than the other two SVS concepts. Consistent with previous results, the Size A display is considered less effective because of the increased minification factors entailed by its small size, and the HUD is considered less effective because of its fixed field of regard. In general, the pilots' SA rating with the baseline concept was low and their SA rating with the SVS concepts was high during the approach.

SVS displays/texture - The Display Type results from the SVS-only analysis were consistent with the above Baseline/SVS Displays analysis. Terrain Texture ($F(1,75)=11.800$, $p<.001$) and the interaction between SVS Display Type and Texture Type ($F(2,75)=3.933$, $p<.024$) were significant for this measure during departure. The photo-realistic texture (mean = 7.85) obtained a higher mean situation awareness rating for the departure task than did the generic texture (mean = 7.42), but the significant interaction between SVS Display Type and Texture Type (shown in Figure 26) indicated that this effect was only present for the HUD (see Figure 26).

The Texture Type effect was negligible for the HDDs. Operationally, these results were considered not significant, as the situation awareness ratings were all high.

VSD Enhancement Questionnaire Results

Subjects were asked to rate how much their SA was increased with the VSD during the approach and departure tasks using the: 1) baseline EADI with TAWS and VSD enhanced ND; 2) SVS Size A; 3) SVS Size X; and 4) SVS HUD. Subjects were asked to rate the VSD addition to the ND on a scale of 0 to 10 (0 being 0% enhancement and 10 being 100% enhancement).

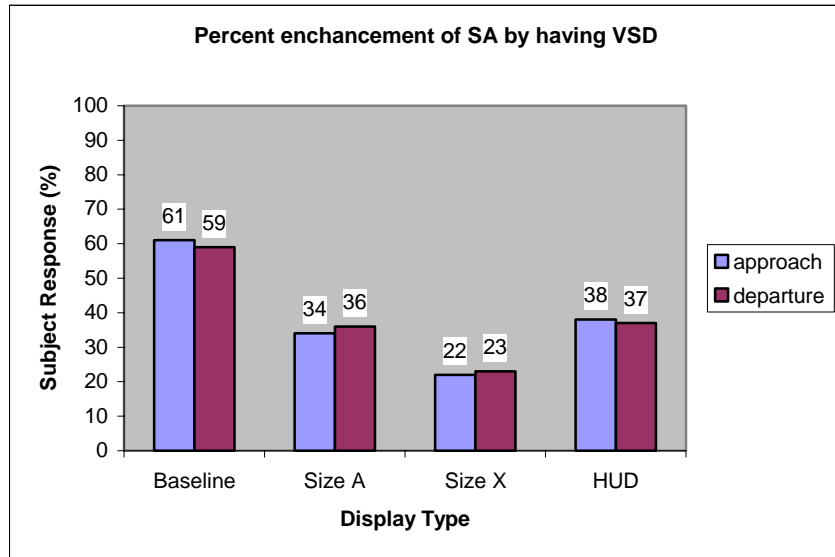

Figure 27. Percent enhancement of SA by having VSD for each display type.

Approach Path

During approach (Figure 27), Display Type ($F(3, 63)=12.201, p<.001$) was highly significant for the measure of the VSD percentage enhancement to SA. Post Hoc tests (using SNK with $\alpha=.05$) indicated that the VSD was judged to have significantly enhanced SA for the baseline concept (mean=61 percent enhancement) with TAWS and VSD enhanced ND as compared to the SVS concepts (mean=34 percent for Size A, mean=22 percent for Size X and mean=38 percent for HUD). Also, the SNK test showed that the Size X rating was significantly different from that of the HUD but had no appreciable difference from that of the Size A rating. In addition, there were no significant differences between the ratings for the Size A and the HUD. These within-SVS concept results are consistent with the previously found subjective preferences for the Size X display concept (interpreting the results as meaning that the Size X display required less terrain enhancement).

Departure Path

During the departure (Figure 27), Display Type ($F(3, 63)=11.125, p<.001$) was highly significant for the measure of the VSD percentage enhancement to SA. Post Hoc tests (using SNK with $\alpha=.05$) indicated that the VSD was judged to have significantly enhanced SA for the baseline concept (mean =59 percent enhancement) with TAWS and VSD enhanced ND as compared to the SVS concepts (mean=36 percent for

Size A, mean=23 percent for Size X and mean=37 percent for HUD). The SVS concept rating differences were not statistically detectable.

Inferences from the On-site Qualitative Results

In all analyses of ratings related to workload and situation awareness, pilots judged the baseline concept to have higher workload and lower situation awareness as compared to the three SVS Concepts. Among the SVS concepts, rating differences were small, but the Size X display garnered the better ratings, followed by the HUD and the Size A display. These results are entirely consistent with the numerous research studies previously discussed. The Size A display is considered less effective because of the increased minification factors entailed by its small size, and the HUD is considered less effective because of its fixed field of regard. Not surprisingly, the VSD was judged to improve terrain awareness most for the baseline concept, where the only other terrain information was present on the TAWS. Among the SVS concepts, the ratings varied in a manner reflective of the workload and SA results above.

Of particular interest in light of the objective data results concerning the guidance commands and symbology differences during approach and departure are the associated subjective results. On approach, the tunnel or pathway and flight path marker symbology were judged easier to use and interpret than the conventional attitude flight director. On departure, the single cue ball referenced to the flight path marker garnered better ratings than the dual cue flight director bars referenced to the attitude symbol. These subjective results for departure, along with the findings that the baseline concept increased the pilots' workload rating as compared to the three SVS Concepts, are in direct correlation with the potential explanations of lateral path tracking performance results for departure advanced earlier in the "Inferences from the Quantitative Data" section (i.e., poorer tracking performance with the baseline concept because of increased workload demands imposed by the guidance symbology and the requirement to scan for terrain information).

Post Experiment Questionnaire

At the conclusion of the experiment, each subject was given a "take home" questionnaire packet to be completed and mailed back. Fourteen of the sixteen questionnaires were returned and the responses are included in Appendix G. The purpose of the questionnaire was to provide feedback for improving SVS displays. In addition, the pilot subjects were asked for their opinion on possible operational benefits of SVS. A summary of the subjects' responses are provided below:

1. The Size X with photo-realistic terrain was the preferred display. Though photo-realistic texturing was preferred, subjects rated the generic texture as acceptable. The larger Size X provided more SA compared to the Size A display. The Size A was adequate to perform the task; however, its small size made symbology interpretation difficult. Color terrain was preferred over the monochrome terrain due to its intuitive view of the outside world. Also, color symbology made interpretation of the Size X display easier than the monochrome HUD.
2. Subjects felt the HUD with a terrain database image enhanced SA. For crew coordination purposes, subjects recommended both the pilot and co-pilot have an SVS enhanced HUD if it were to be implemented in the commercial fleet without SVS head down displays. The pilots recommended that the presentation of synthetic terrain on the HUD be pilot selectable. They were concerned that the synthetic terrain would clutter the HUD in VMC or when breaking out of a cloud bank.
3. Overall, pilots liked the tunnel and ghost airplane guidance concept on the SVS displays. The pilots liked the anticipatory cues the tunnel gave for path changes. The ghost airplane provided a target for the velocity vector, making it easy to fly the path.
4. Pilots preferred having selectable FOV. A 30 degree FOV was preferred for approach and 60 degree FOV for the departure. The smaller FOV allowed pilots to "fine tune" the approach on final. The larger FOV was used

for departure mainly because of the large angle of attack imposed, which required more vertical SA. In addition, 60 degree FOV provided more horizontal terrain awareness for the departure maneuver.

5. Subjects recommended both a HUD and HDD SVS solution for current and future aircraft.
6. Pilots felt that SVS would best support arrival and approach operations, although they felt SVS would be beneficial in all phases of flight including taxi operations.

Summary of Inferences

SVS concepts are dramatically different from the displays of today's commercial cockpit, yet with little training the subjects were able to fly the complex task with better performance compared to a typical EFIS display, with which they were very familiar. In addition, the SVS reduced mental workload and provided better SA for terrain awareness. Combining this precision guidance capability with the intuitive nature of the SVS terrain information has the potential to eliminate precursors to accidents that have low visibility as a causal factor. The results of the present experiment confirm the efficacy of SVS to enhance a flight crew's terrain awareness and be proactive to avoid CFIT accidents. Although TAWS and VSD provide a graphical presentation of terrain information, these displays require the flight crew to integrate the information from the two separate 2-D displays in order to form a mental image of the 3-dimensional terrain. Because SVS provides a dynamic and accurate display of the outside world, synthetic vision allows the flight crew to cognitively map the terrain information to an analog of what it naturally represents; a mountain in the synthetic vision display looks like a mountain in the real world. Thus, interpretation of these displays is intuitive and allows the flight crew to identify emergent situations that can cause CFIT accidents.

The scenario used in the present experiment represents such an example. In this case, the pilot flew multiple approaches before being exposed to the CFIT scenario. Often, these accidents happen with an otherwise experienced flight crew who had flown the same route many times previous to the CFIT encounter. Rather than one major error on the part of the flight crew, CFIT situations often arise from a series of small seemingly inconsequential events that collectively result in an accident. Numerous examples of such accidents illustrate this point (e.g., Cali, 1995; Khatmandu, 1990; Madrid, 1983), and the CFIT scenario used in the experiment was no different than conditions that caused these accidents. Instead, many of the pilots that experienced a CFIT noted that they were lulled into a state of complacency. They had flown the same departure twenty-one times previously and each time they noted that they were getting TAWS indications that high terrain was present, but also knew that the safe passage was available through the "notch" in the mountain. They never expected that something may go wrong with their flight guidance and, therefore, "trusted" that they were on-path despite indications on the VSD that something was wrong. Essentially, they lost their vigilance. A similar situation happened to the pilots who flew the SVS, but they had one advantage --- synthetic vision. They, too, reported that the last departure did not initially appear to be any different than the previous twenty-one missed approaches. However, there was one key difference. The velocity vector seemed to be leading them directly into the mountain rather than through the path between the peaks. Therefore, this allowed for "recognition primed" decision making to know that something was "not right" and that they needed to crosscheck other instruments. In fact, even before TAWS would have alerted the flight crew, several pilots began to change their flight path and began to laterally maneuver the aircraft so they could continue the approach through the mountain pass. With the baseline displays, there would be no way that a flight crew could have executed such a maneuver because of the limited resolution of the terrain presentation. Rather, upon hearing the TAWS alert, the flight crew is left with the singular solution of "pull up, pull up" which because of reduce climb performance would not have allowed them to escape colliding with the terrain. Although new technologies are being developed to allow TAWS to provide both lateral and vertical escape guidance, it still cannot equate to the situation awareness provided by having a realistic "picture" of the outside world available to the flight crew at all times. As one of the evaluation pilots observed, "a picture may be worth a thousand words, but with synthetic vision, a picture is worth a thousand lives."

The quantitative analyses showed the subject pilots flew the SVS displays with greater precision compared to the baseline concept. These results were obtained for the approach task for both lateral and vertical error over the entire approach and within each individual segment, with the single exception of vertical error for segment 4. For that segment, which involved flying a straight and level path with no changes, no vertical path differences were detectable. Similar results were obtained for the lateral error for the departure task, where the control law guidance provided to the pilot was the same between the baseline and SVS display concepts. The major difference on departure between the baseline concept and its SVS Size A display counterpart was the terrain presentation and the velocity vector. No pathway was present. And yet the lateral FTE was significantly lower for the SVS displays. Differences in the RMS speed-on-pitch error were not significant throughout the departure task.

Thus for both the approach and departure tasks, the flight guidance symbologies embodied within the SVS displays provided superior performance compared to the flight guidance symbologies embodied within the baseline concept. Also, the run questionnaires support this conclusion, as pilots rated the baseline flight guidance as requiring high mental workload and as being more difficult to follow than the SVS display guidance. From these data, the conclusion is the presentation of the guidance symbology is highly beneficial, enhancing the pilot's ability to perform the task. Though the tunnel and ghost presentation of approach guidance used very different guidance laws from the departure guidance, the subject task is the same as the single integrated guidance symbol (the "ball") used for departure. The task for both of these guidance concepts is to simply put the velocity vector on the guidance cue while the dual cue flight director requires zeroing two separate guidance symbols. Subjective comments showed pilots liked the "look ahead" features that the tunnel and ghost airplane provided over the ball. The ghost airplane gave subjects an indication of where the guidance was going. Additionally, the tunnel pathway allowed pilots to anticipate on-coming turns in the path.

Among the SVS concepts, objective performance differences and subjective rating differences were small. When such differences existed in FTE, the trends always varied directly with the display minification factor, with the best performance occurring with the conformal HUD. When such differences existed in subjective rating differences, the Size X display garnered the better ratings, followed by the HUD and the Size A display. The Size A display is considered less effective because of the increased minification factors entailed by its small size, and the HUD is considered less effective because of its fixed field of regard and its monochrome presentation. Both objective and subjective results are entirely consistent with the numerous research studies conducted within the SVS Project.

Conclusions

The rare event portion of the simulation experiment demonstrated quite dramatically that a synthetic vision system (SVS) will improve the pilot's ability to detect and avoid a potential Controlled Flight Into Terrain (CFIT) event compared to the baseline 757 EFIS display system. This CFIT benefit has been advanced as one primary motivation for SVS displays (another primary motivation is to replicate the operational benefits of flight operations in bright, clear, sunny day conditions, regardless of the outside weather). In addition, the backdrop retrofit display simulation experiment confirmed once again the prior flight test and simulator results revealing the enhanced situation awareness, reduced workload, and reduced flight technical error provided by all of the SVS (HDD and HUD) concepts compared to the baseline display configuration, regardless of display size. These additional results firmly establish the SVS HDD retrofit concept approach as viable for operations in a realistic, terrain-challenged environment.

References

- Aviation Communication and Surveillance Systems (ACSS; 2003). T2CAS product description. Phoenix, AZ: ACSS.
- Bailey, R.E., Parrish, R.V., Arthur III, J.J., & Norman, R.M. (April 2002). Flight Test Evaluation of Tactical Synthetic Vision Display Concepts in a Terrain-Challenged Operating Environment. In Proceedings of SPIE, Enhanced and Synthetic Vision 2002. Editor: Jacques G. Verly, Volume 4713, pp. 178-189.
- Bailey, R. E.; Parrish, R. V.; Kramer, L. J.; Harrah, S. D.; and Arthur, J. J., III (September 2002). Technical Challenges In the Development of a NASA Synthetic Vision System Concept, Proceedings of the North Atlantic Treaty Organization (NATO) Symposium on Enhanced and Synthetic Vision Systems. <http://avsp.larc.nasa.gov/pdfs/csrp25.pdf>
- Baize, D.G. & Allen, C.L. (November 5, 2001). Synthetic Vision Systems Project Plan, Version IIIId. NASA Langley Research Center.
- Boeing (1998). Statistical summary of commercial jet aircraft accidents, Worldwide Operations, 1959-1997. Seattle, WA: Airplane Safety Engineering, Boeing Commercial Airplane Group.
- Boff, Kenneth R.; & Lincoln, Janet, eds.(1988): Engineering Data Compendium-Human Perception and Performance, Volume II, pp. 1644-1645. Harry G. Armstrong Aerosp. Med. Res. Lab., Wright-Patterson Air Force Base.
- Breen, B.C. (2001). Enhanced situation awareness. In C. Spitzer (Ed.), Avionics Handbook. Boca Raton, FL: CRC Press.
- Brooks, P.E. (1997). Highway in the sky: Our legacy is safety on the road ahead. Flightline, July/August, 16-22.
- De Muynck, R.J., & Khatwa, R. (1999). Flight simulator evaluation of the safety benefits of terrain awareness and warning systems. AIAA Guidance, Navigation, and Control Conference (AIAA 99-3965). Reston, VA: AIAA
- Enders, J.H., Dodd, R., Tarrel, R., Khatwa, R., Roelen, A.L.C., & Karwal, A.K. (1996). Airport safety: A study of accidents and available approach-and-landing aids. Flight Safety Digest, 1996(3), 1-36.
- Federal Aviation Administration (1996). National plan for civil aviation human factors: An initiative for research and application. Washington, D.C.: FAA.
- Glaab, L. J., Kramer, L. J., Arthur, J. J., & Parrish, R. V. (May 2003). Flight Test Comparisons of Synthetic Vision Display Concepts at Dallas/Fort Worth International Airport. NASA TP-2003-212177.
- Honeywell (2000). Description of the Enhanced Ground Proximity Warning System. Redmond, WA: Honeywell International.
- Khatwa, R., & Roelen, A. (1996). An analysis of controlled-flight-into-terrain (CFIT) accidents of commercial operators, 1988 through 1994. Flight Safety Digest, 1996(4), 1-19.
- Kuchar, J.K. & Hansman, R.J. (1993). Part-Task Simulator Evaluations of Advanced Terrain Displays. SAE Aerotech '93 paper 932570.
- Ladkin, P. B. (1997). Risks of technological remedy. Communications of the ACM, 40, 160.
- Lintern, G., Roscoe, S.N., & Sivier, J.E. (1990). Display principles, control dynamics, and environmental factors in pilot training and transfer. Human Factors, 32, 299-317.

- Matthews, S. (1997). Proposals for improving aviation safety and changing the system. International Conference on Aviation Safety and Security in the Twenty-First Century. Washington, D.C.: U.S. Government.
- Merrick, V.K., Jeske, J.A. (April 1995). Flight Path Synthesis and HUD Scaling for V/STOL Terminal Area Operations. NASA TM-110348
- Minimum Aviation System Performance Standards: Required Navigation Performance for Area Navigation (RTCA; 2000). RTCA DO-236A. Washington, D.C.: RTCA, Incorporated.
- Moroze, M.L., & Snow, M.P. (1999). Causes and remedies of controlled flight into terrain (CFIT) in military and civil aviation. Proceedings of the 10th International Symposium on Aviation Psychology. Columbus, OH: Ohio State University.
- Muynch, R.J. & Khatwa, R. (September 1999). Flight Simulator Evaluation of the Safety Benefits of Terrain Awareness and Warning Systems. NLR-TP-99379.
- Prevot, T. (May 1998). A Display for Managing the Vertical Flight Path – an Appropriate Task with Inappropriate Feedback. Proceedings of HCI-Aero. Montreal, Canada.
- Prinzel, L.J., Kramer, L.J., Bailey, R., Hughes, M., & Comstock, R. (2002). NASA Eagle-Vail Synthetic Vision Flight Test. Proceedings of the Human Factors and Ergonomics Society 46th Annual Meeting, 46.135-139.
- Reason, J. (1990). Human error. Cambridge: Cambridge University Press.
- Scott, W.B. (November 4, 1996). New technology, training target CFIT losses. Aviation Week & Space Technology, 73-77.
- Simmon, D.A. (1998). Boeing 757 CFIT Accident at Cali, Columbia, becomes focus of lessons learned. Flight Safety Digest, 17, 1-31.
- Snow, M.P., & Reising, J.M. (1999). Effect of pathway-in-the-sky and synthetic terrain imagery on situation awareness in a simulated low-level ingress scenario. In 4th Annual Symposium on Situation Awareness in Tactical Air Environment pp 198-207, Patuxent River, MD, NAWCAD.
- Society of Automotive Engineers (1995). Human factors issues associated with terrain separation assurance display technology. SAE Aerospace Resource Document ARD50062. Warrendale, PA: SAE.
- Theunnisen, E. (1997). Integrated design of a man-machine interface for 4-D navigation. Delft University Press.
- Vidulich, M.A., & Hughes, E.R. (1991). Testing a subjective metric of situation awareness. In Proceedings of the Human Factors & Ergonomics Society 35th Annual Meeting (pp. 1307-1311). Santa Monica, CA: Human Factors & Ergonomics Society.
- Wickens, C.D., & Prevett, T. (1995). Exploring Dimension of Egocentricity in Aircraft Navigation Display: Influence on Local Guidance and Global Situation Awareness. Journal of Experimental Psychology: Applied, 1, 110-135.
- Wiener, E. L. (1977). Controlled flight into terrain accidents: System-induced errors. Human Factors, 19, 171-181.
- Williams, D., Waller, M., Koelling, J., Burdette, D., Doyle, T., Capron, W., Barry, J., & Gifford, R. (2001). Concept of operations for commercial and business aircraft synthetic vision systems. NASA Langley Research Center: NASA Technical Memorandum TM-2001-211058.

Appendix A: SVS Guidance

The guidance presented to the pilot depended on the task (approach or departure) and display type (baseline or SVS). Table 6 indicates the guidance symbology presented to the pilot. For baseline data runs, the flight guidance was a typical dual cue (Figure 28) flight director providing guidance to the approach and departure path. However, the vertical guidance for the departure path was speed on pitch. For the SVS data runs, pilots flew the approach procedure with tunnel (or highway-in-the-sky) and ghost airplane guidance (Figure 29, Merrick & Jeske, 1995). The ghost airplane, rendered as two triangles and an aiming circle, is pursuit type guidance which is 30 seconds ahead on the intended path. The ghost airplane would pitch and yaw giving the pilot the intended movement of the guidance. The departure guidance symbology for the SVS runs was an integrated single cue symbol (or “the ball”) providing the same lateral and vertical path guidance as the baseline display concept. The guidance laws for the flight directors are shown in Figures 30 - 32. In addition, DME on the 059 radial of SXW was displayed for the departure. The ghost airplane pursuit guidance is described in the Merrick reference.

Table 6. Flight guidance symbology presented to pilot based on phase of flight and display type

	Baseline display	SVS display
Approach	Dual cue (pitch & roll bars)	Ghost airplane and tunnel
Departure	Dual cue (pitch & roll bars)	Integrated ball (speed on pitch/lateral path)



Figure 28. Baseline approach and departure dual cue (pitch and roll command bars) flight director symbology.

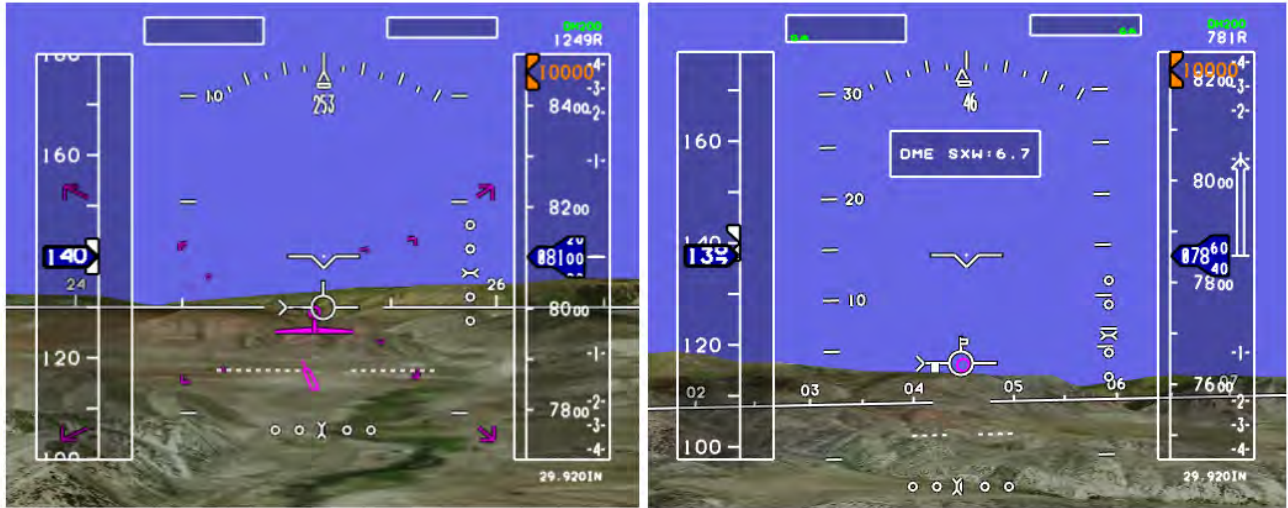

Figure 29. SVS guidance symbology: approach (left) ghost airplane with tunnel and departure (right) integrated single cue guidance (“ball”).

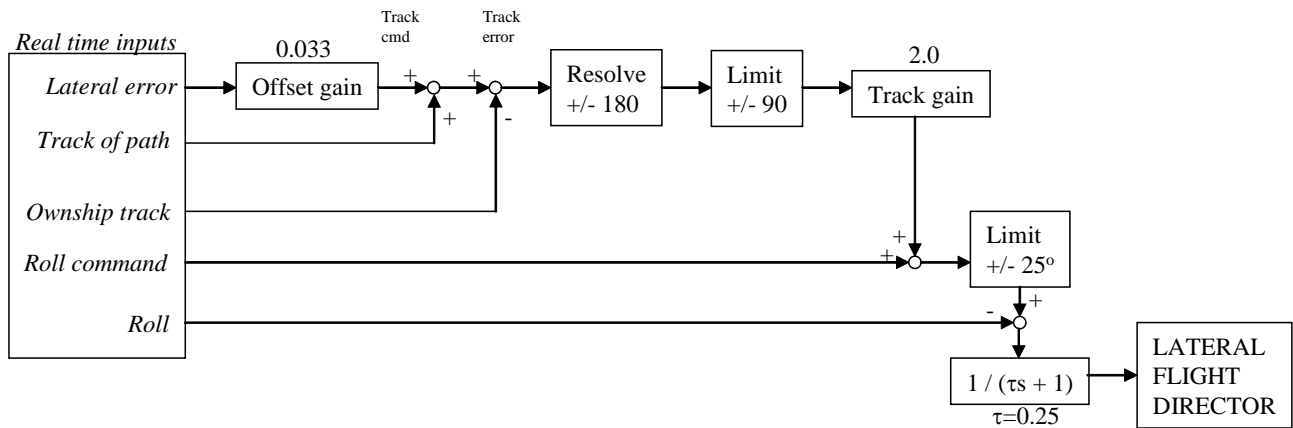

Figure 30. Lateral flight director for baseline concept approach tasks and for baseline and SVS concepts departure tasks.

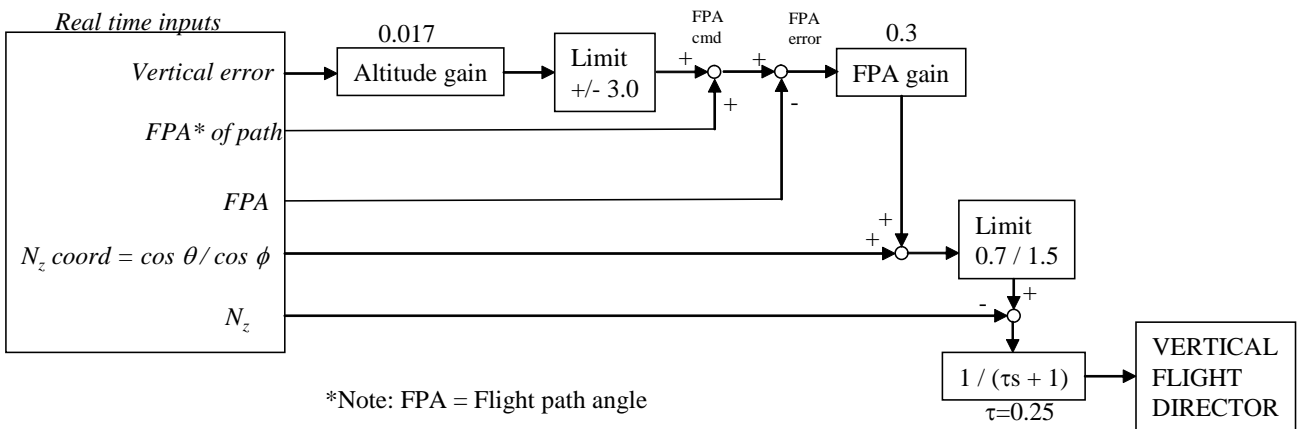

Figure 31. Vertical flight director for the baseline concept approach task.

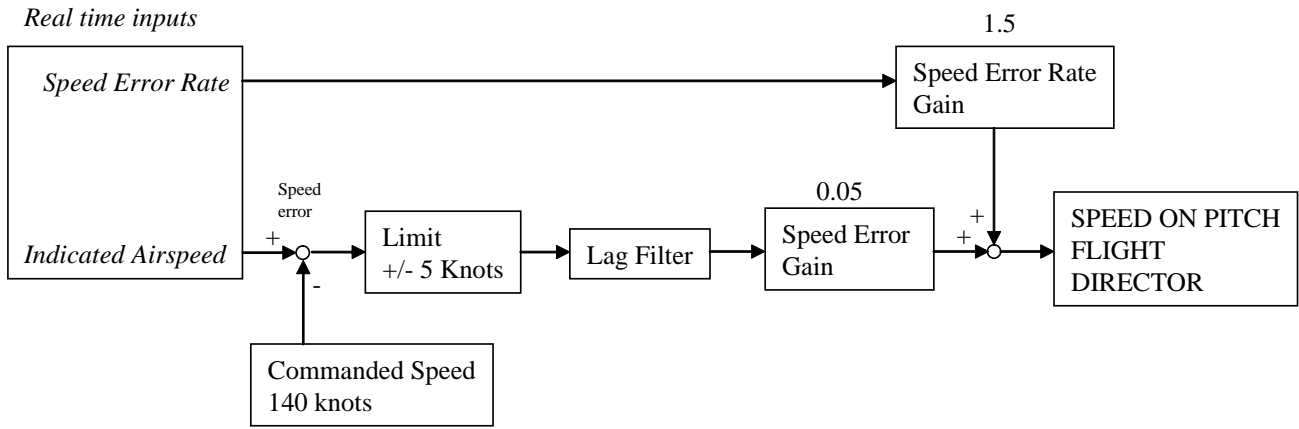

Figure 32. Speed-on-pitch flight director for all display concepts departure tasks.

Appendix B: Required Navigation Performance

Required navigation performance (RNP) is a statement of the navigation performance accuracy necessary for operation within a defined airspace. RNP airspace is a generic term referring to airspace, routes, and legs, where minimum navigation performance requirements have been established and aircraft must meet or exceed that performance to fly in that airspace. The system performance requirements for RNP Area Navigation (RNAV) is that each aircraft operating in RNP airspace shall have total system error components in the cross-track and along-track directions that are less than the RNP value 95% of the flying time. RNP type is a designator according to navigational performance accuracy in the horizontal plane (lateral and longitudinal position fixing). This designator invokes all of the navigation performance requirements associated with the applicable RNP number, which is a containment value. For example, RNP-1 means that for at least 95% of the time the navigational performance in the horizontal plane, or the total horizontal system error, is less than 1.0 nautical mile (nmi). In addition to requiring 95% positioning accuracy for RNP operations, these types of procedures also require integrity of the positioning accuracy at 99.999% at $2 \times$ RNP number. In our example above with an RNP-1, the position accuracy within 2.0 nmi of the ownship ($2 \times$ RNP value of 1.0 nmi) would have to be guaranteed to be correct 99.999% of the time to enable RNP-1 operations.

There are three lateral components of navigation error: path definition error, path steering error, and position estimation error (RTCA, 2000). These errors, defined in the following, represent the total horizontal system error of the airplane and are the difference between the aircraft's true position and desired position (Figure 33):

The path definition error is the difference between the defined path and the desired path at a specific point.

The path steering error is the distance from the estimated position to the defined path. It includes both the flight technical error (FTE) and display error. FTE is the accuracy with which the aircraft is controlled as measured by the indicated aircraft position with respect to the indicated command or desired position.

The position estimation error, also referred to as the ship's actual navigation performance (ANP), is the difference between the true position and the estimated position.

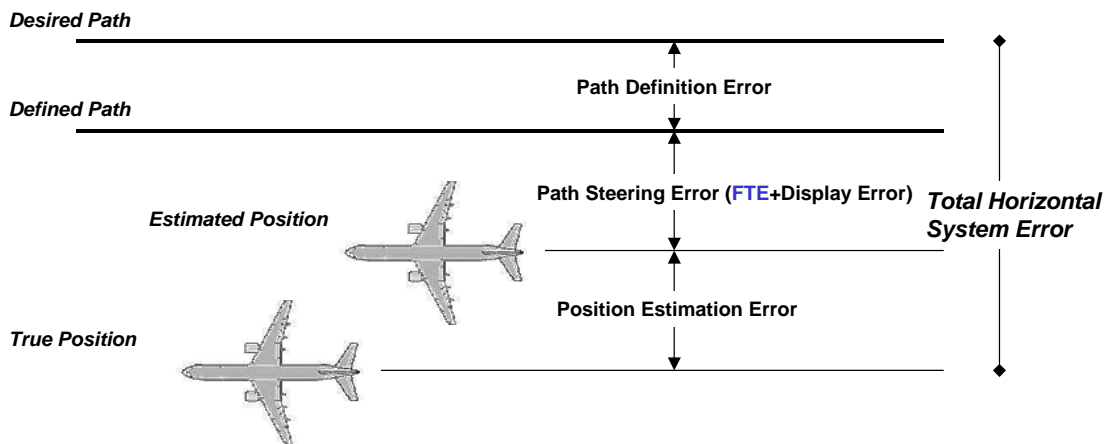

Figure 33. Lateral components of navigation error terms

Vertical navigation (VNAV) capability further enhances flight operations by enabling the specification of a flight path vertically for the lateral flight path. The system performance requirements for VNAV are that for at least 99.7% of the time the navigational performance in the vertical plane, or the total vertical system error, is less than a specified altitude deviation measure based on the airspace being flown in (below 5000 feet MSL, 5000-10000 feet MSL, above 10000 feet MSL) and the type of flight operation (level flight/climb/descent or flight along specified vertical profile) being performed (Table 7).

There are four vertical components of navigation error: altimetry system error, vertical path steering error, vertical path definition error, and horizontal coupling error (RTCA, 2000). These errors, defined in the following, represent the total vertical system error of the airplane and are the difference between the aircraft's true vertical position and desired vertical position at the true lateral position (Figure 34):

Altimetry system error is the error attributable to the aircraft altimetry installation, including position effects resulting from normal aircraft flight attitudes.

The vertical path steering error is the distance from the estimated vertical position to the defined path. It includes both FTE and display error.

The vertical path definition error is the vertical difference between the defined path and the desired path at the estimated lateral position.

The horizontal coupling error is the vertical error resulting from horizontal along track position estimation error coupling through the desired path.

Table 7. Vertical Accuracy Performance Requirements

Error Source	Level Flight Segments and Climb/Descent Intercept of Clearance Altitudes (MSL)			Approach along Specified Vertical Profile (MSL)		
	At or Below 5000 ft	5000 ft to 10000 ft	Above 10000 ft	At or Below 5000 ft	5000 ft to 10000 ft	Above 10000 ft
Altimetry	90 ft	200 ft	250 ft	140 ft	265 ft	350 ft
RNAV Equipment	50 ft	50 ft	50 ft	100 ft	150 ft	220 ft
Flight Technical	150 ft	240 ft	240 ft	200 ft	300 ft	300 ft
Total Root-Sum-Square (RSS)	190 ft	320 ft	350 ft	265 ft	430 ft	510 ft

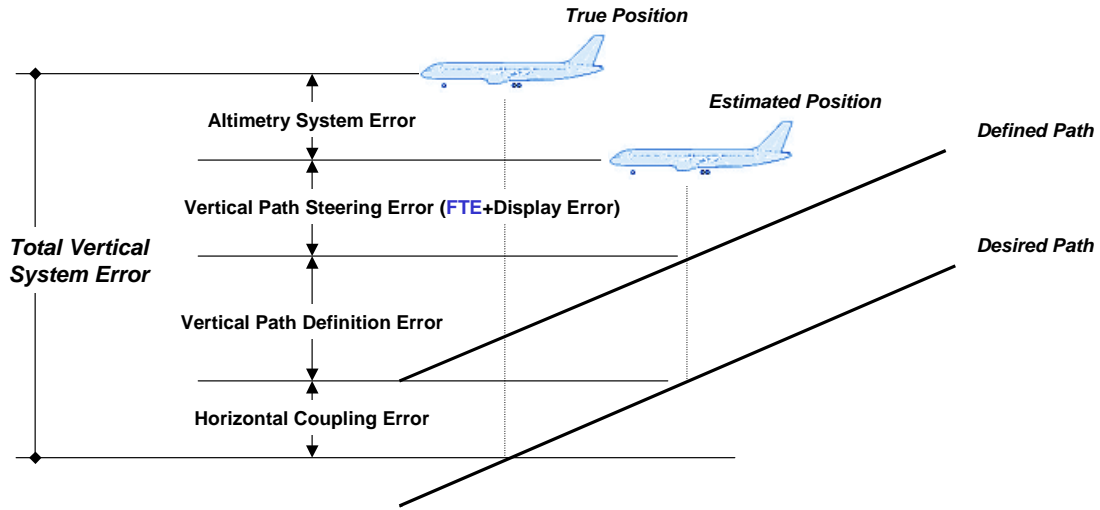

Figure 34. Vertical components of navigation error terms

Appendix C: Miscellaneous Figures



Figure 35. Baseline display.

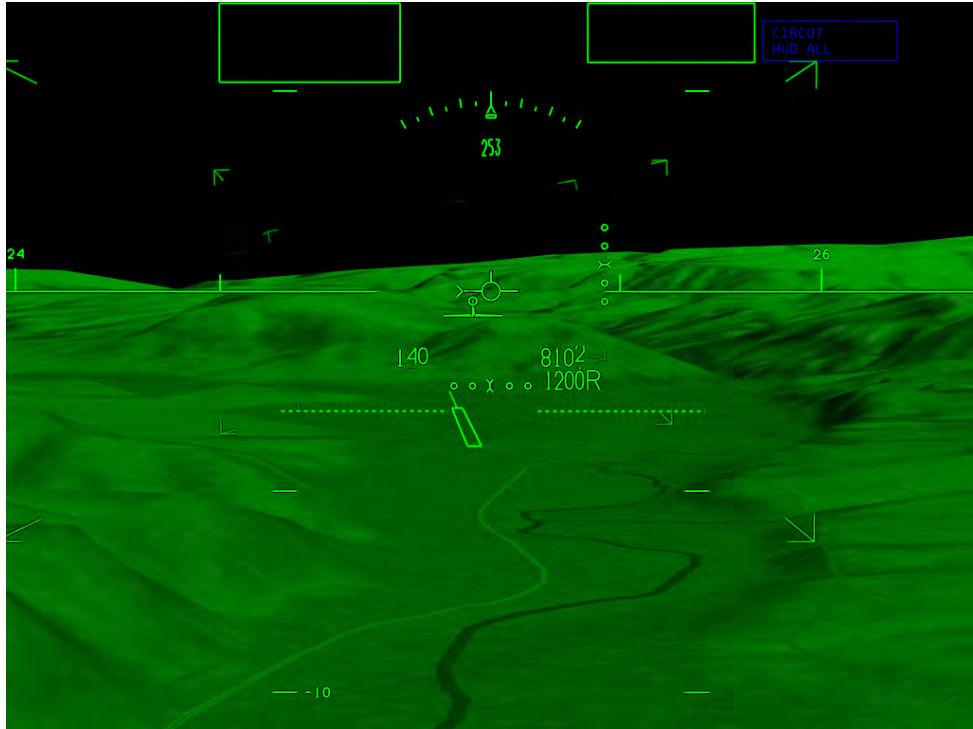

Figure 36. HUD with generic textured terrain.

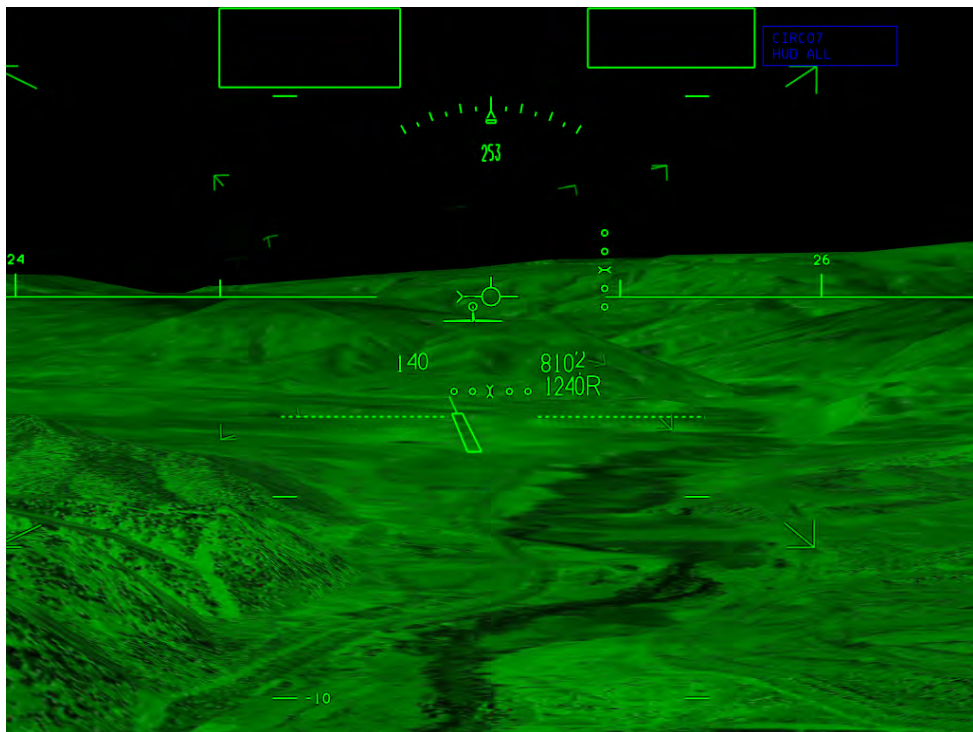

Figure 37. HUD with photo-realistic textured terrain.



Figure 38. Size A with generic textured terrain.



Figure 39. Size A with photo-realistic textured terrain.



Figure 40. Size X with generic textured terrain.

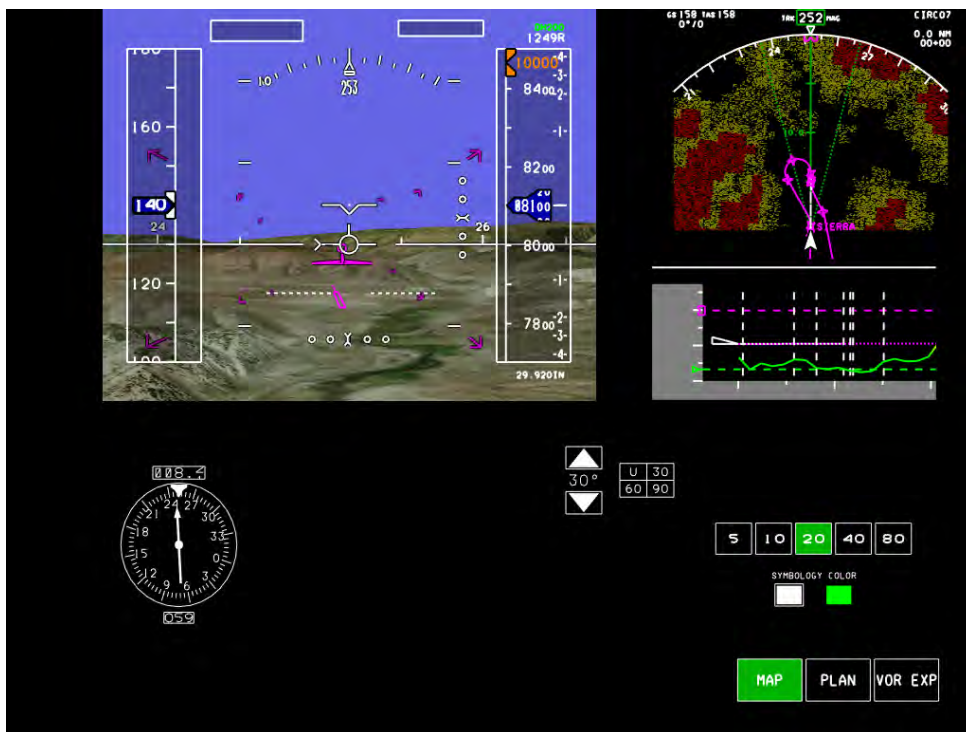

Figure 41. Size X with photo-realistic textured terrain.



Figure 42. Baseline display on departure.

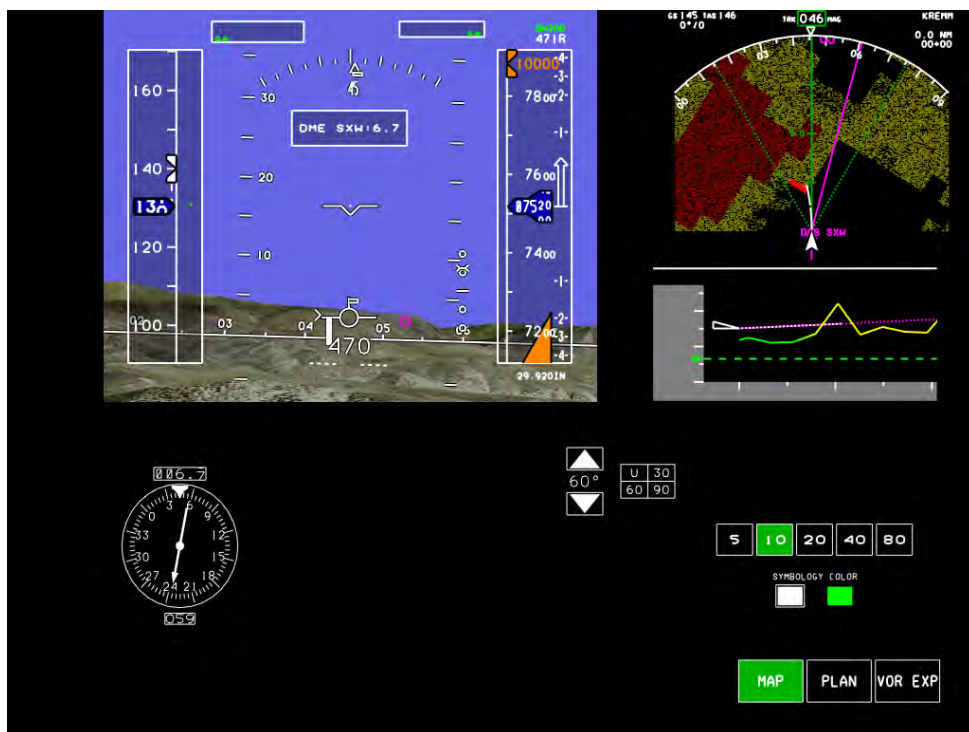

Figure 43. Size X display on departure.



Figure 44. Size X photo-textured terrain on final to EGE runway 7.

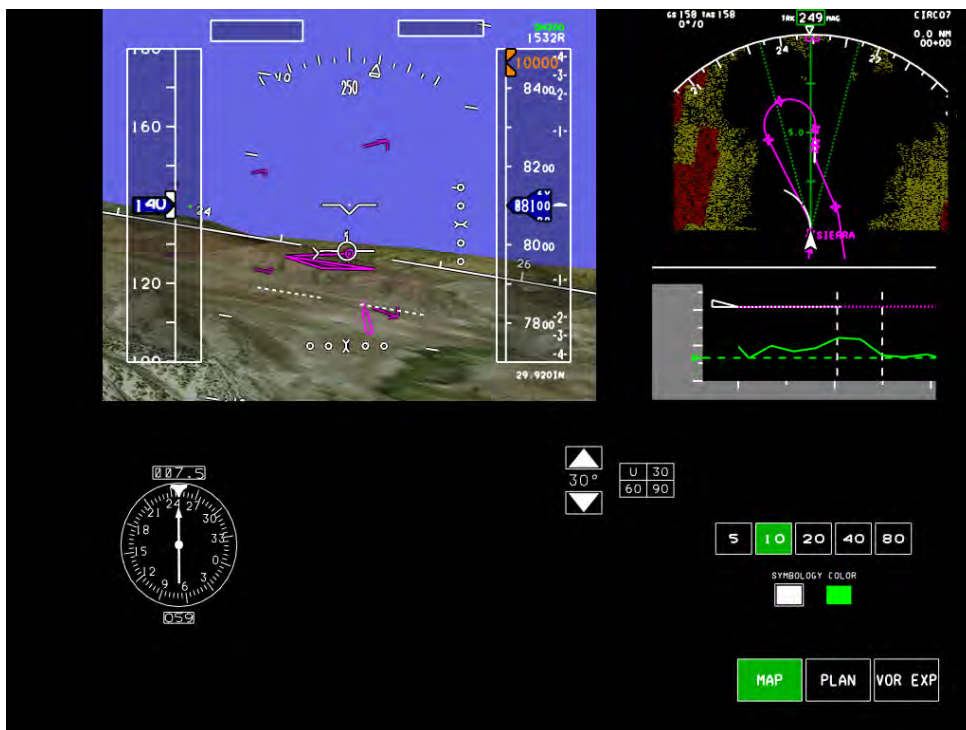

Figure 45. Size X photo-realistic terrain in a left turn.

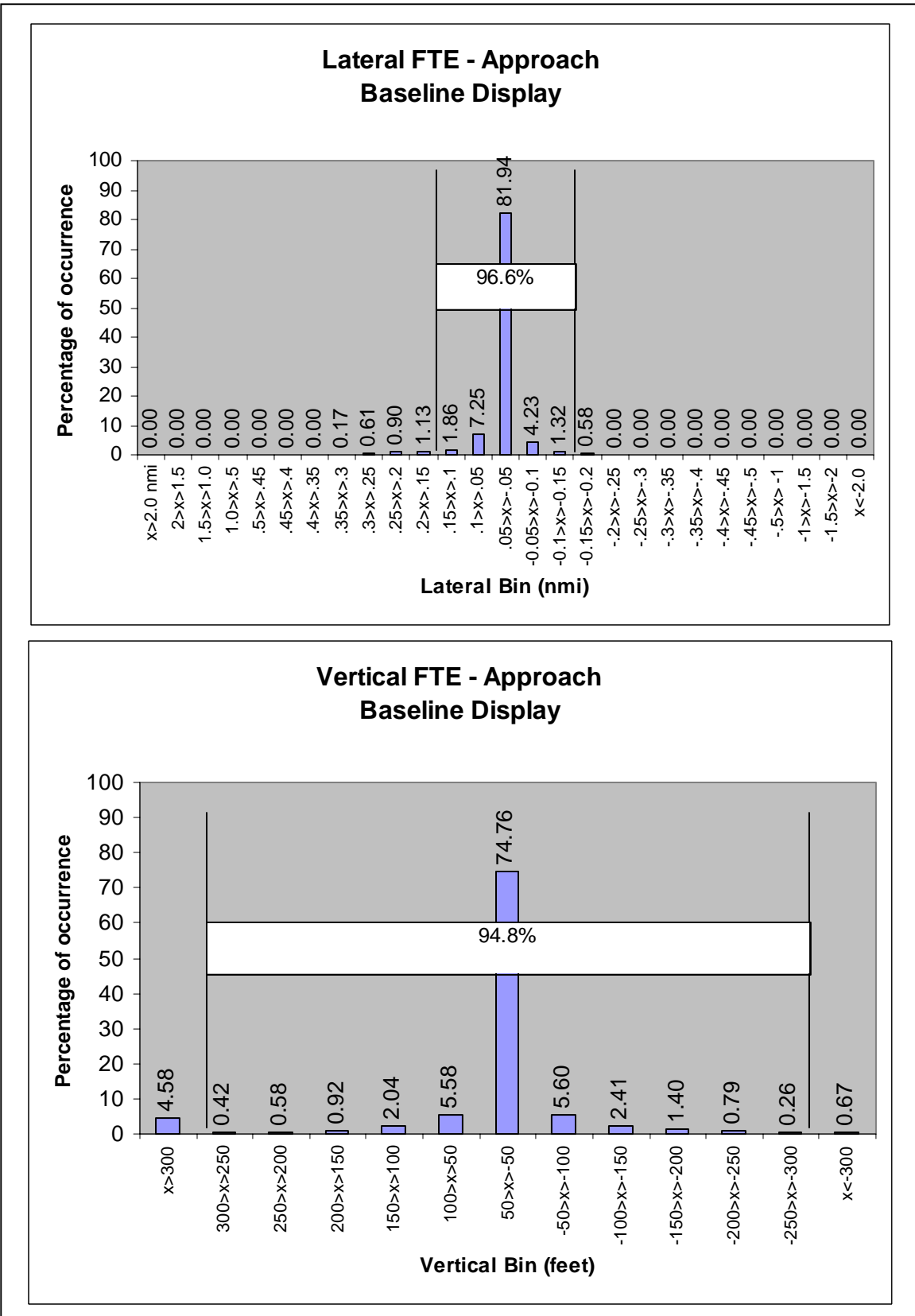

Figure 46. Lateral and Vertical FTE for the baseline display.

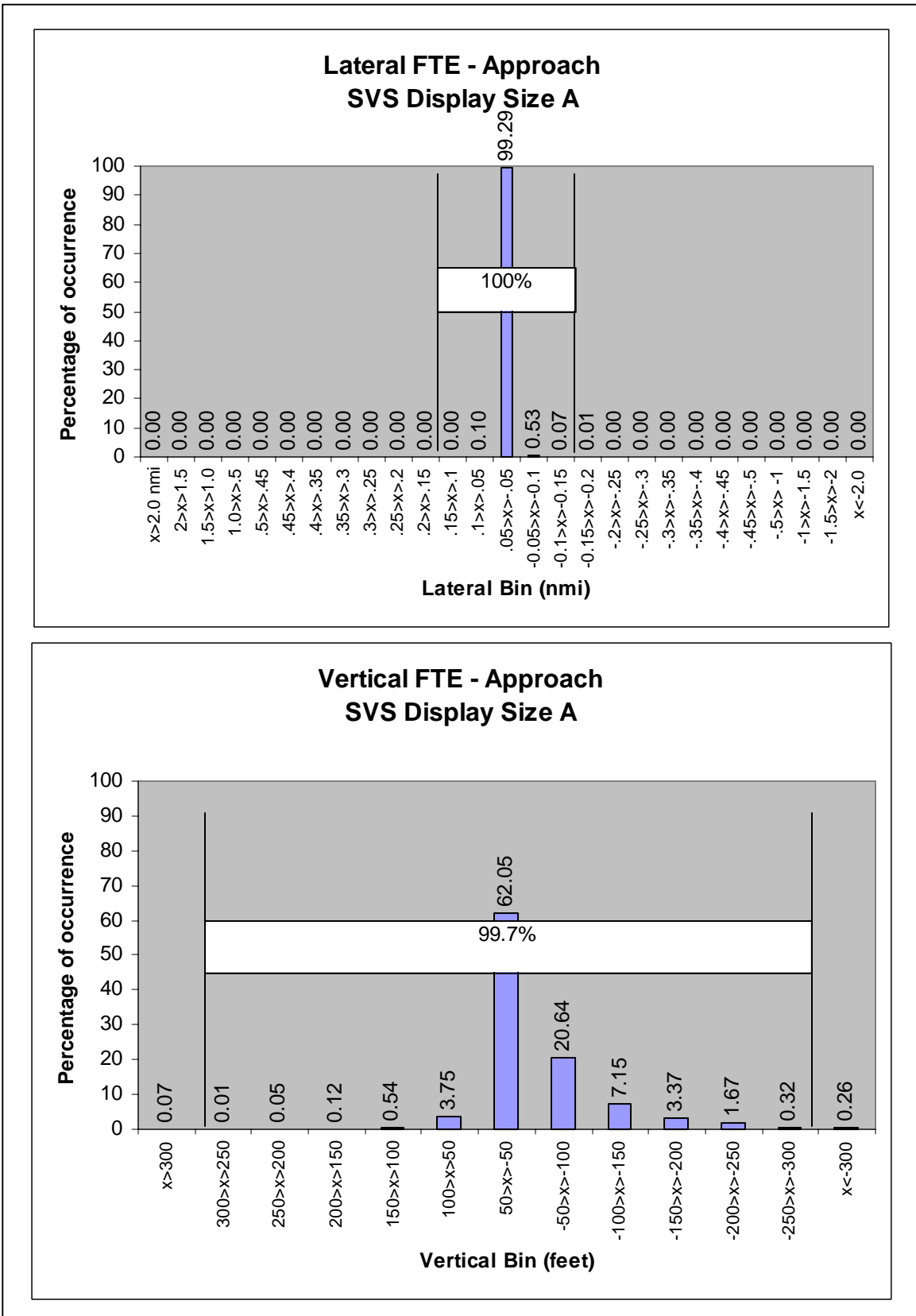

Figure 47. Lateral and Vertical FTE for the SVS Size A display.

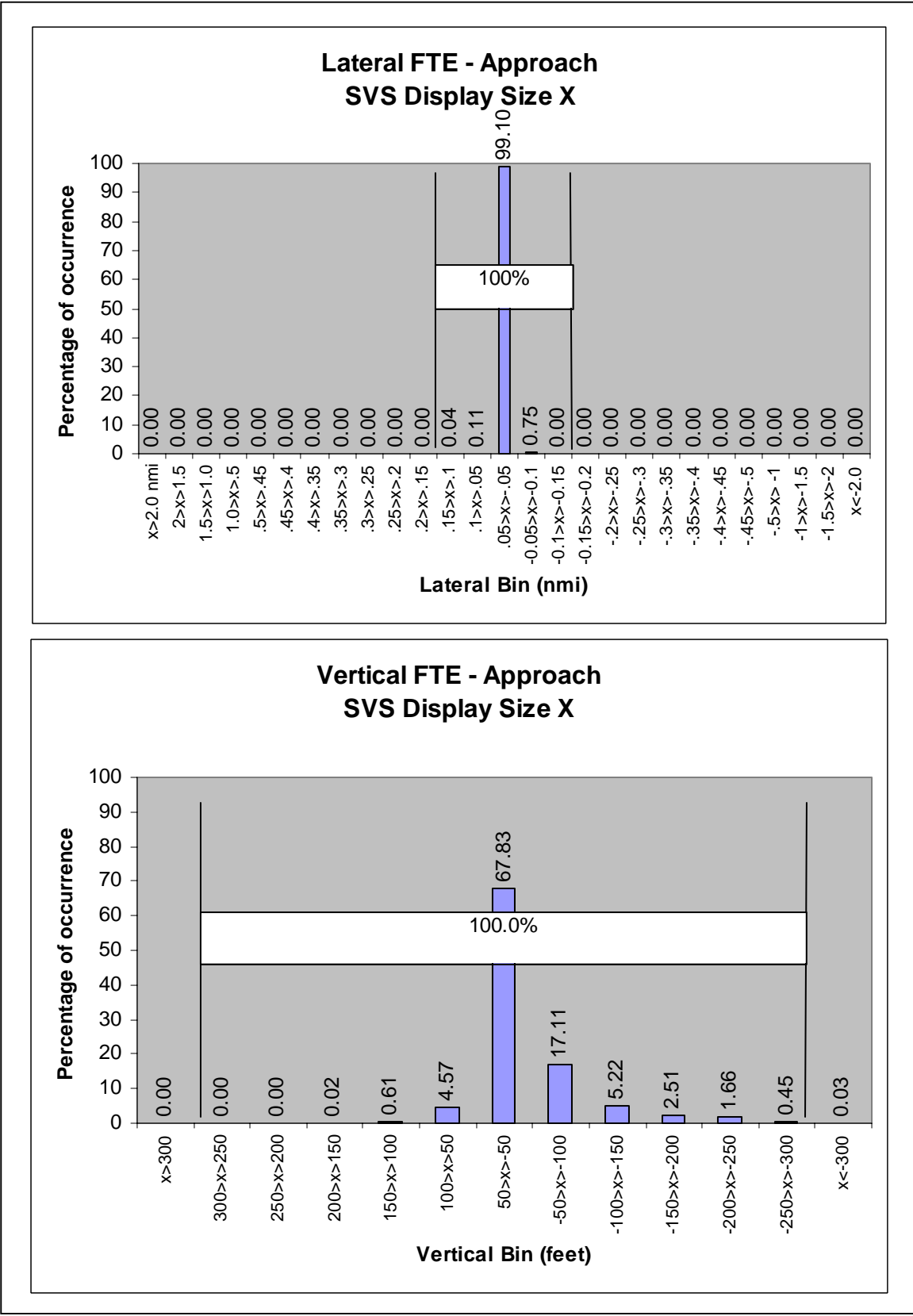

Figure 48. Lateral and Vertical FTE for the SVS Size X display.

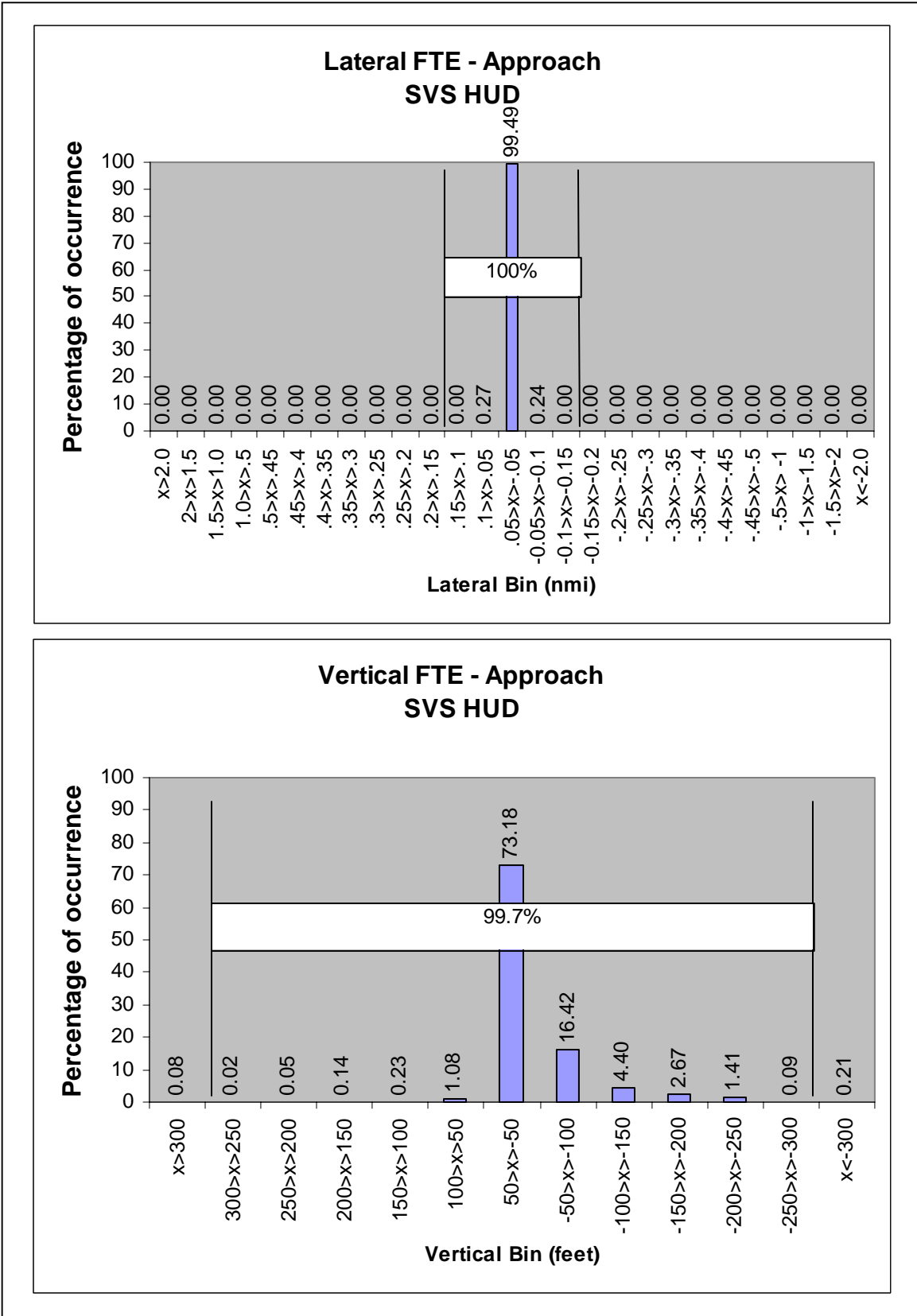

Figure 49. Lateral and Vertical FTE for the SVS HUD.

Appendix D: Between Run Questionnaires

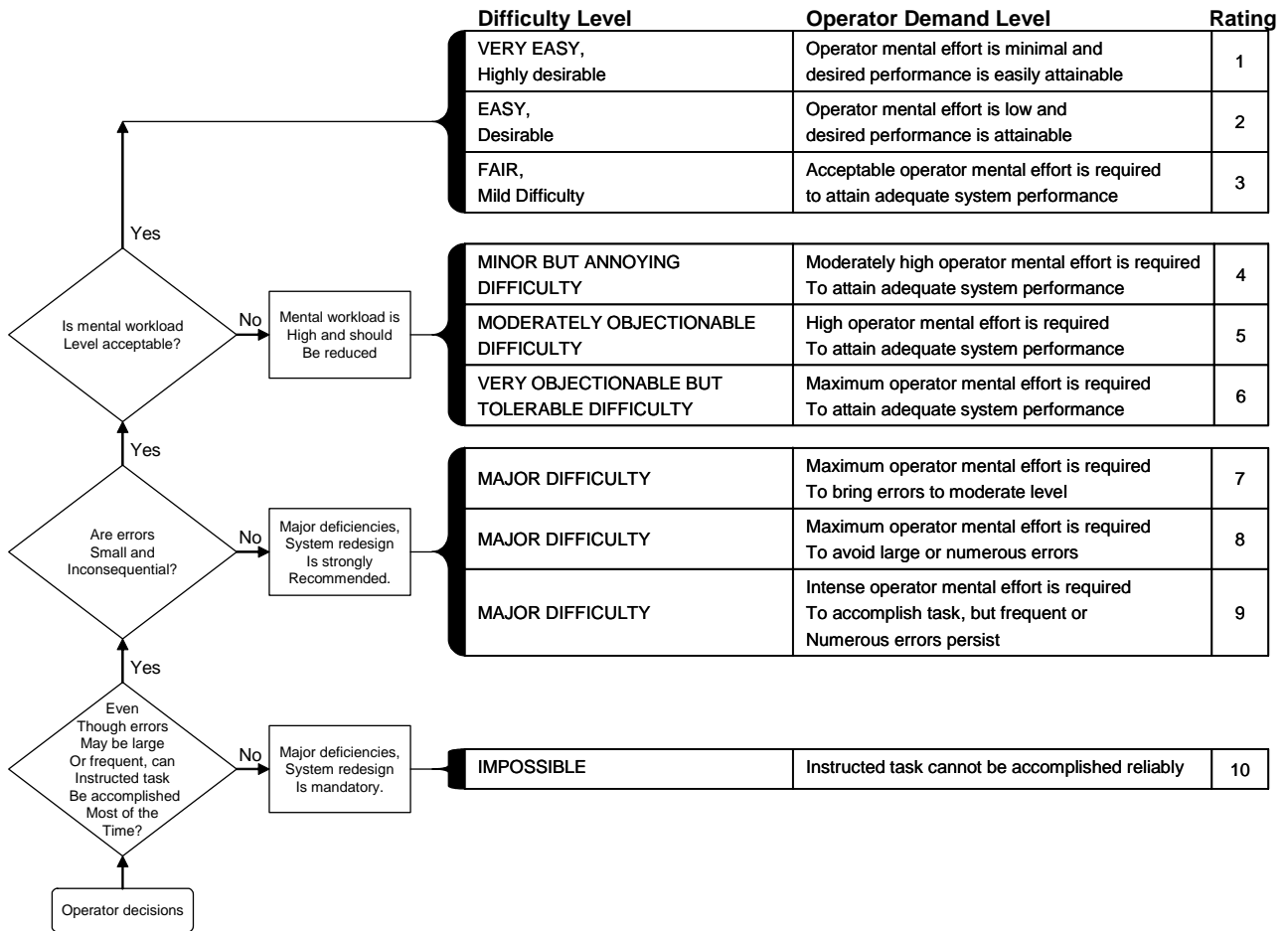

Figure 50. Modified Cooper Harper scale asked between runs.

RUN QUESTIONNAIRE

STRONGLY DISAGREE	MODERATELY DISAGREE	SLIGHTLY DISAGREE	SLIGHTLY AGREE	MODERATELY AGREE	STRONGLY AGREE
1	2	3	4	5	6

- 1.) **IT WAS EASY TO DETERMINE AIRCRAFT POSITION WITH RESPECT TO THE TERRAIN:** _____
COMMENTS: _____

- 2.) **I WAS CONFIDENT IN MY KNOWLEDGE OF SEPARATION FROM TERRAIN:** _____
COMMENTS: _____

- 3.) **IT WAS EASY TO INTERPRET THE GUIDANCE CUES** _____
COMMENTS: _____

- 4.) **IT WAS EASY TO FOLLOW THE GUIDANCE CUES:** _____
COMMENTS: _____

- 5.) **DISPLAY INFORMATION WAS CONFUSING AT TIMES:** _____
COMMENTS: _____

- 6.) **I COULD PERFORM THIS TASK WITH EASE AND PRECISION:** _____
COMMENTS: _____

Figure 51. Run Questionnaire asked between each data run.

Appendix E: Miscellaneous Data Tables

Table 8. Time to Detect CFIT

Subject	Display	DME value at detection	seconds before CFIT
1	Baseline	CFIT	
2	SizeX	8.3	82.3
3	SizeA	9.2	59.1
4	Baseline	CFIT	
5	SizeA	10.2	33.4
6	HUD	9.8	43.7
7	HUD	10.8	18.0
8	HUD	8.5	77.1
9	SizeA	11.2	7.7
10	SizeX	10	38.6
11	SizeX	8.4	79.7
12	SizeA	8.2	84.9
13	Baseline	CFIT	
14	HUD	10.8	18.0
15	SizeX	7.6	100.3
16	Baseline	CFIT	
		Average time	53.6

Table 9. Subject Experience

Subject	Years flying	Total hours
1	17	8000
2	20	9500
3	25	6200
4	24	7200
5	17	6000
6	13	4800
7	13	10000
8	20	1800
9	13	3480
10	25	10226
11	33	15000
12	24	15500
13	30	14100
14	15	7000
15	14	9500
16	11	2508
Average	19.625	8175.875
Min	11	1800
Max	33	15500

Appendix F: Pilot Responses to Semi Structured Interview

1. Please rate the ease of performing the approach to rwy 7 using the traditional EADI with flight director and TAWS + VSD

SUBJECT 1: Rating of 5. Familiarity of approach and use of displays helped, but the displays lacked SA and was difficult interpreting the flight guidance

SUBJECT 2: Rating of 4. Command bars to put on dot required a lot more concentration

SUBJECT 3: Rating of 4. Not exactly what I am used to flying and I don't have the luxury of having a PNF; SVS was significantly better than baseline

SUBJECT 4: Rating of 3. Just not a display I would want to fly these approaches with. Lots of workload and very poor SA.

SUBJECT 5: Rating of 4. I felt like I could make the approaches if I had to, but I sure wouldn't want to.

SUBJECT 6: Rating of 4. Complicated approach relative to traditional approach and after flying the SVS concepts it redefines what is easy. Without seeing SVS, would have given different rating.

SUBJECT 7: Rating of 5. Feel like playing catch up. Working the needles.

SUBJECT 8: Rating of 5. You could do it, but wasn't very easy but not too bad. You don't have some of the cue and can't see the terrain.

SUBJECT 9: Rating of 4. Lack of precision.

SUBJECT 10: 7. With the TAWS and VSD, it gives you some confidence with regard to the terrain and where the airplane is.

SUBJECT 11: 8. As far as just the ease of flying, there is just not much to do. There are not a lot of step down maneuvers, etc.

SUBJECT 12: 4. The hardest of all the ones that I saw today.

SUBJECT 13: 3. The pitch did not seem to work very well except when you were stabilized. Had to do a lot of cross checking to get back ok. Occlusion dot should not be obscured by the command bars. Look at the 777 PFD and the white box as example.

SUBJECT 14: 3. Basically, the scan is slower and takes longer to interpret the terrain awareness. Gives you an idea of whats out there but you have to work to construct a 3D world with 2D information

SUBJECT 15: 3. Symbology unfamiliar

SUBJECT 16: 6. Have good vertical guidance over terrain.

Missed approach?

SUBJECT 1: Rating of 5. Same reason

SUBJECT 2: Rating of 6. Same reason

SUBJECT 3: Rating of 4. Same reason

SUBJECT 4: Rating of 4. Same reason

SUBJECT 5: Rating of 4. Same reason

SUBJECT 6: Rating of 5. Not as much maneuvering so a little higher rating. But basically the same as approach

SUBJECT 7: Rating of 4. A little harder. Single engine coming out of there had it been really engine out it would have been very difficult.

SUBJECT 8: Rating of 6. The missed approach is almost procedural and if you follow those procedures. Doesn't make it very easy, but without the terrain depiction becomes labor intensive

SUBJECT 9: Rating of 7. It was easier going up than coming down.

SUBJECT 10: 6. Concern there was the turns I wasn't comfortable out near the end with the bright red TAWS

SUBJECT 11: 5. There is a lot to do. You have to do a turn to immediately and there is no altitudes you had to watch leading to a 5 rating.

SUBJECT 12 : 6. Easier. I wasn't as concerned about circle approach

SUBJECT 13: 2. Speed on pitch and following the FD and if you follow it religiously would get big PIO

SUBJECT 14: 3. Same Reason

SUBJECT 15: 4. Symbology unfamiliar

SUBJECT 16: 7. Liked having the speed guidance on the EADI.

2. Evaluate the ease of using the HUD photo-texture during the approach to rwy. 7

- SUBJECT 1: Rating of 7. Terrain features were great and provided good SA. Guidance got lost in the background*
- SUBJECT 2: Rating of 6 although though generic was a little fuzzier than photo*
- SUBJECT 3: Rating of 8. Excellent presentation of terrain and I could easily make out the runway and where I needed to go to make the approach*
- SUBJECT 4: Rating of 7. With the exception of the fixed FOV, the HUD photo is an excellent display*
- SUBJECT 5: Rating of 8. Very easy to fly.*
- SUBJECT 6: Rating of 7. The ground makes all the difference in the world regardless of whether it is photo or generic*
- SUBJECT 7: Rating of 8. Great SA.*
- SUBJECT 8: Rating of 8 to a 9. Very easy. The only thing that made the HUD a little difficult was the sensitivity of the HUD (because of fixed FOV)*
- SUBJECT 9: Rating of 7. It certainly more accurate but requires more flight tuning in terms of flight controls and eye-hand coordination.*
- SUBJECT 10: 8. You didn't have to do any interpretation mentally. The picture was there.*
- SUBJECT 11: 6. It seemed to me more sensitive to inputs and the way it was laid out doing the PIOs and also the FOV sometimes.*
- SUBJECT 12: 7. Because SA higher, I could see everything in relation to everything.*
- SUBJECT 13: 7. Roll control seem much more sensitive generally for the simulator*
- SUBJECT 14: 8. Real 3D and your heads outside and minimizes heads down workload*
- SUBJECT 15: 4 Following symbology is very sensitive.*
- SUBJECT 16: 9. Problem was the sensitivity of the symbology. Trend indicator really helped on the VV*

3. Evaluate the ease of using the HUD generic-texture during the approach to rwy. 7

- SUBJECT 1: Rating of 7. Same Reason as Q. 2*
- SUBJECT 2: Rating of 6. Problems with pegged velocity vector which affected SA*
- SUBJECT 3: Same*
- SUBJECT 4: Same*
- SUBJECT 5: Same*
- SUBJECT 6: Rating 6. Photo had better depth perception*
- SUBJECT 7: Rating of 8. Same reason.*
- SUBJECT 8: Rating of 8 to 9. HUD generic actually in some cases was not easier to use but it had better contrast to it. With the better contrast, you could pick up features and weren't worried about shadows, etc.*
- SUBJECT 9: Rating of 7. Same reason*
- SUBJECT 10: Same and same reason.*
- SUBJECT 11: Same and same reason*
- SUBJECT 12: 8. I could see the nose relative to the terrain.*
- SUBJECT 13: 6. Symbology was a little small for what should be on HUD; flashing / pegged velocity vector. Recommendation would be to keep it steady and use a dash or something to minimize attention capture.*
- SUBJECT 14: 7. Your attention outside is a little longer to pick out the terrain features.*
- SUBJECT 15: Same*
- SUBJECT 16: Liked using the HUD and being able to look at versus look down a lot.*

4. Evaluate the ease of performing a missed approach to rwy. 7 using the HUD generic-texture display concept

SUBJECT 1: Rating of 7. Same as for Photo. No real perceived difference IN TERMS of “ease of performing”

SUBJECT 2: Rating of 6. Same as Q. 3

SUBJECT 3: Same

SUBJECT 4: Same

SUBJECT 5: Same

SUBJECT 6: Rating 6. Same as for Q3

SUBJECT 7: Rating of 8.

SUBJECT 8: Rating of 8 to 9. Very easy.

SUBJECT 9: Rating of 8. Same reason

SUBJECT 10: 8. Wasn't all that too different. Generic presentation is good enough to give you a warm and fuzzy that terrain is not there.

SUBJECT 11: Same

SUBJECT 12: 5. Wasn't any information on there mostly because missing waterline and lots of distracting information. Really didn't do much for me.

SUBJECT 13: 7. Same

SUBJECT 14: Same

SUBJECT 15: 5. Same problem. Not as difficult as approach.

SUBJECT 16: 7. Same

5. Evaluate the ease of performing a missed approach to rwy. 7 using the HUD photo-texture display concept

SUBJECT 1: Rating of 2. “Meatball” provided very poor guidance

SUBJECT 2: Rating of 7. Photo a little better than generic but needs work especially with FOV and losing terrain features when velocity vector gets on bottom of display

SUBJECT 3: Same

SUBJECT 4: Same

SUBJECT 5: Same

SUBJECT 6: Rating of 7 for same reason

SUBJECT 7: Rating of 8. Excellent SA.

SUBJECT 8: Same as photo

SUBJECT 9: Rrating of 8. Same reason

SUBJECT 10: Same.

SUBJECT 11: Same

SUBJECT 12: Same

SUBJECT 13: Same

SUBJECT 14: Same

SUBJECT 15: Same

SUBJECT 16: Same

6. Please comment on the perceived differences in using the HUD photo-texture and HUD generic-texture during the approaches to runway 7.

SUBJECT 1: None really. The photo terrain was sharper but both conveyed the same level of information needed to fly approach

SUBJECT 2: Fuzzier concept; terrain wasn't that helpful on approach but helpful for missed. Provided good SA but not as good as HDD

SUBJECT 3: Generic was really good for picking out those things I need to know where they are; however, it was not very good at helping me determine how far I was away from terrain

SUBJECT 4: Photo realistic really increased SA compared to generic although generic is way better than what we have today. No question about it.

SUBJECT 5: Really liked both to be honest although photo was easier to fly. Generic however was just a bit worse not really that much compared to photo.

SUBJECT 6: Depth perception is superior in HUD Photo; 3D ability to differentiate above ground seem a little more realistic

SUBJECT 7: Little to none. Slightly better definition on Photo.

SUBJECT 8: Contrast was the big thing to me. I found sometimes that the HUD had much better contrast and I could discriminate things better. Photo sometimes I would lose the ghost.

SUBJECT 9: The photo is much better in clarity, contrast, and I would even say topographical changes. It is easier to pick up the differences. I had a hard time with generic in judging distances

SUBJECT 10: Although the HUD photo was more detailed, it didn't flow as smoothly. Maybe the graphics. The generic seemed more smoother. The photo texture was nice as it was very detailed.

SUBJECT 11: The photo is more scarier to fly as you start to see more of the terrain; it is "more realistic".

SUBJECT 12: The HUD photo has more important information presented the only bad thing about HUD photo was sometimes you could use the velocity vector or flight director (didn't have control over brightness and contrast). Important information includes ridge line, etc.

SUBJECT 13: Generic is fine when you are higher up. Photo is very essential when you get into areas that are close to the terrain. Had a much more comfortable feel when you are really high up. Need to have dual databases or separate sources for EGPWS and SVS to minimize complacency.

SUBJECT 14: The generic takes longer to pick out key terrain features although simple acquisition of features like rivers, etc.

SUBJECT 15: I thought the photo just having that texture in the background gave me a lot more confidence in relation to where I was with respect to terrain.

SUBJECT 16: Always liked the photo better because it was crisper.

7. Please rate which NASA HUD display concept (e.g., generic) provided the best level of situation awareness in performing the missed approach to runway 7. (Situation awareness defined as: "...the pilot has an integrated understanding of the factors that will contribute to the safe flying of the aircraft under normal or non-normal conditions.").

SUBJECT 1: Rating of Photo

SUBJECT 2: Rating of Photo

SUBJECT 3: Photo

SUBJECT 4: Photo

SUBJECT 5: Photo

SUBJECT 6: Photo

SUBJECT 7: Photo.

SUBJECT 8: Generic

SUBJECT 9: Photo

SUBJECT 10: Photo.

SUBJECT 11: Equal

SUBJECT 12: HUD Photo

SUBJECT 13: HUD Photo

SUBJECT 14: HUD Photo

SUBJECT 15: HUD Photo

SUBJECT 16: HUD Photo

Please elaborate on your answer and discuss the reason for your choice of HUD display concept

SUBJECT 1: The HUD Photo was a little sharper and easier to fly because it provided more details (i.e., texture gradients)

SUBJECT 2: Texture was much better; with generic relied on instruments whereas with Photo could use terrain depiction more

SUBJECT 3: Just a little better than generic although I liked both a lot.

SUBJECT 4: Generic was a bit washed out and hard to really tell where you were relative to terrain.

However, if I stay with published approach procedures, generic is excellent in giving me tactical feedback that I am ok.

SUBJECT 5: Photo was better but not much better. Gave details that I would like to have if cost was not a consideration.

SUBJECT 6: See #6 above

SUBJECT 7: More easily scanned and interpreted what is out there. Just the generic doesn't give as much but it is not as detailed but little real difference

SUBJECT 8: Contrast but you liked the photo because it looked real. Looked like it should. But caveat that, how does it look like when we break out how does the real world look like.

SUBJECT 9: Sharper and I could judge distance better.

SUBJECT 10: Liked the photo because you could pick out roads and other cultural features especially with approach with requires visual contact with features.

SUBJECT 11: Both provide an adequate amount of SA

SUBJECT 12: Just gave so much more information than the generic concept

SUBJECT 13: It was nice. It gives you much more SA there is certain things that are easily identifiable.

Generic features should be put in to make it easier to pick out key cultural, etc. features.

SUBJECT 14: Provides a better picture of surrounding terrain; shade of grey comparison. HUD generic was close to Photo but photo did give you better SA and more confidence

SUBJECT 15: Just the presentation. The Photo was better in terms of terrain depiction and I could better trust the presentation.

SUBJECT 16: Crisper. Better resolution. More confidence.

8. Please discuss whether how the use of a tunnel (without flight director) would affect the operational safety and use of the NASA HUD display concept for approaches to rwy. 7

SUBJECT 1: It was nice to have just in case you got out of the tunnel

SUBJECT 2: Sense of that I knew I was ok if I was still in tunnel

SUBJECT 3: Tunnel was great.

SUBJECT 4: Tunnel helped you know that you were still on the path and even if you were not right on the guidance, the tunnel provided that sense of safety comfort that you don't normally get with traditional instruments and displays

SUBJECT 5: Tunnel could be of big help for RNP and curved approaches.

SUBJECT 6: The only thing I noticed about the tunnel is that the tunnel started to tunnel before I started to turn so I thought I was drifting but got used to it

SUBJECT 7: I think lateral deviations would greater in number

SUBJECT 8: I liked the tunnel. The tunnel was good because it provided a very nice manageable trend information. I could see ahead and help with staying ahead of the aircraft.

SUBJECT 9: It didn't detract but didn't find it helpful

SUBJECT 10: Tunnel was good for the turns and to know they are coming. Would like to have distance to go to next waypoint.

SUBJECT 11: I don't think it really did much at all because you don't have the different colors so it didn't stand out that much. Didn't use the tunnel.

SUBJECT 12: Liked it. But it was much better PFD than HUD. It was distracting on the HUD and didn't use it as much in the HUD.

SUBJECT 13: Its there and it is kinda of a peripheral and I looked at it a few times but I think you are mostly focused on ghost and the tunnel is a nice adjunct. If you are outside the tunnel to find your way back to the path.

SUBJECT 14: Liked it. What I liked about you could see ahead of the tunnel that the path was going to turn; good anticipation.

SUBJECT 15: Not as helpful on the HUD as HDD. Contrast in not as good in the HUD. Magenta better stands out in the HDD. There is so much busy work on the HUD that the tunnel doesn't show up as well.

SUBJECT 16: In the beginning, I didn't use it but towards the end I was using it a great deal. I finally realized that the tunnel gave me a representation of the radius of turn which I couldn't get from the ghost.

9. Please provide any additional comments that would be helpful in evaluating the HUD display concept

SUBJECT 1: None

SUBJECT 2: None

SUBJECT 3: Excellent display.

SUBJECT 4: Concern about fixed FOV and sensitivity of FMA and other guidance

SUBJECT 5: Velocity vector really sensitive; a lot of workload

SUBJECT 6: Would give up the tunnel before ghost; really liked HUD concept but concerned about fixed FOV especially in turns and high AoA with the velocity vector getting pegged and losing terrain depiction

SUBJECT 7: Really like it. Clear, concise, easily interpreted.

SUBJECT 8: None

SUBJECT 9: The HUD is my preference for one particular reason for the OTW transition.

SUBJECT 10: ghost I didn't really like. It was much more aggressive than I would have flown and wasn't as smooth as the command bars

SUBJECT 11: May get a lot of PIO when going. VSI missing. Everything I need wasn't all presented on the HUD and had to cross-check it inside.

SUBJECT 12: The only thing I didn't like is with the missed approach there is no way to get any peripheral information in the HUD once it gets pegged with just the doughnut.

SUBJECT 13: I actually don't know the value of the waterline I know what it is there but I would assume have had an AoA indicator than the waterline and it got in the way.

SUBJECT 14: The HUD in general, the FOV is too limited and it gets pegged and makes it difficult to follow FD cues on GA.

SUBJECT 15: I thought the HUD was the most difficult to fly with the exception of the baseline. It would be better than A if the sensitivity of the symbology was improved. Fixed FOV was difficult to fly.

SUBJECT 16: Excellent!

10. Evaluate the ease of predicting flight path using the "follow me aircraft"

SUBJECT 1: 8. SUBJECT stated that it provided excellent "look ahead"

SUBJECT 2: 8. Good preview. Little aggressive in turns

SUBJECT 3: 8. With the exception of when it turned, the FMA was easily to understand and follow

SUBJECT 4: Almost too easy.

SUBJECT 5: Great guidance aid; I felt that, once I was comfortable with the display, I could easily manage the approach using the FMA

SUBJECT 6: 8. Seemed intuitive; it was nice to follow around in the sky; was in the bank turn; visual angle is large instead of looking 70 degrees and should be smaller to reflect; almost fills up too much of the screen

SUBJECT 7: 8. Only gripe with the ghost aircraft has no roll motion just yaw motion. Somewhat unsettling. Can adapt it. Visual perception aspect angle.

SUBJECT 8: 8. Easy. Good prediction with the ghost. I was using the ghost and the noodle together to see the track line. Sometimes the ghost sometimes you would roll inside and if noodle says I'm ok then I didn't have to work about keeping ball on ball.

SUBJECT 9: 8. Great way to maintain flight path guidance

SUBJECT 10: 8. I did find it somewhat distracting at times but I think overall it was very helpful in helping me feel comfortable that I was ok and on the path. See above on comments about ghost and being aggressive.

SUBJECT 11: I thought it was helpful and I used it. It gave the direction to follow and it showed turns, etc.

SUBJECT 12: Really liked it a lot. Liked the 3D of the triangle and gives you the rate and trend of the path and could really fly the approach with VV and ghost.

SUBJECT 13: I liked it but I would reimplement it. I would make bank angle parallel so that the wings of the VV are parallel to the wings of the ghost to denote the bank angle desired

SUBJECT 14: I liked it. It provides good trend information.

SUBJECT 15: The ghost was very good in terms of predictive information and I found it very easy to fly.

SUBJECT 16: Liked that a lot. Great guidance and made the workload much easier.

11. Please provide your comments on the use of the tunnel in the NASA HUD display concept.

SUBJECT 1: Stated in Q. 8

SUBJECT 2: None

SUBJECT 3: None.

SUBJECT 4: I liked it although you would have to supply a declutter option

SUBJECT 5: None.

SUBJECT 6: I like it. You can get carried away so likes the minimized clutter; you can forget you are in airplane

SUBJECT 7: Greatly enhance ability to fly approach and stay in the parameters

SUBJECT 8: Really like that.

SUBJECT 9: see above.

SUBJECT 10: Great concept. Liked that it wasn't too much in your face.

SUBJECT 11: Didn't really use it but could be useful for RNP and sense of staying on path.

SUBJECT 12: It was good that it was magenta for PFD but didn't think it was that great for HUD. The distance and spacing was great.

SUBJECT 13: See above

SUBJECT 14: It was fine. It wasn't distracting and it is much better than boxes like you see in MS flight sim.

SUBJECT 15: see above.

SUBJECT 16: See above.

12. During the approaches to rwy 7 using the NASA SVS HUD, please comment on the use of de-clutter options you would have liked to have available.

SUBJECT 1: An absolute must have. The de-clutter options need to be included because of the terrain you can't see through. I have to be sure that the terrain depiction is right. Also, when I don't need it, I don't want to have it up there.

SUBJECT 2: Would have decluttered the HUD on first 20 degree turn. On break out as well when reached DH

SUBJECT 3: Must have. I would declutter on break out and to check HUD SVS Terrain with OTW.

SUBJECT 4: None.

SUBJECT 5: Very rarely, actually never, are you going to be in 0,0 approach so it is hard to answer question. I liked to have control available to me so yes I would prefer to declutter and would use that feature to check integrity of HUD terrain depiction with outside world.

SUBJECT 6: If I had to turn off anything I would not have had to turn off anything. 0/0 so seldom but it might be enough to be able to adjust the brightness and contrast without having to declutter

SUBJECT 7: HUD didn't see a need to declutter.

SUBJECT 8: On break out would like to declutter and some symbology in the turns.

SUBJECT 9: Would have gotten rid of the tunnel. Other than that I would leave on although the use of terrain on approach is limited.

SUBJECT 10: I think I would like to declutter it to check the real world terrain. I am a little uncomfortable with it being opaque especially if it isn't conformal to the outside world which it doesn't seem to be.

SUBJECT 11: Wouldn't declutter. Would like to add stuff.

SUBJECT 12: Like to declutter only in VMC so I would like to leave everything up. Would like VSI.

SUBJECT 13: No. HUD clutter doesn't bother me although perhaps taking off terrain to verify in less than CAT III. I would have occlusion logic to make it a priority that the ghost and VV are primary and other symbology is secondary. Bank angle should be closer to help with bank angle information. F-16 example puts the bank angle cues on the VV.

SUBJECT 14: In C130J at night approach and get the runway lights, the HUD tends to get washed out. On final approach phase. On final landing segment, keep key symbology. Would like VSI heads-up.

SUBJECT 15: Symbology size was too small in all concepts. Declutter options at EGE would be good but really contrast and brightness controls easily accessible would be great.

SUBJECT 16: on breakout would use declutter and decent weather.

13. Evaluate the ease of using the tunnel for flight path guidance

GENERIC TEXTURE

- SUBJECT 1: Rating of Size A: 8 and Size X: 9*
- SUBJECT 2: Rating of Size A: 7 and Size X: 7*
- SUBJECT 3: A: 7; X: 9*
- SUBJECT 4: A:7; X:8*
- SUBJECT 5: A: 7; X:8*
- SUBJECT 6: Rating of Size A: 6 and Size X: 8*
- SUBJECT 7: Rating of Size A: 6 and Size X: 9*
- SUBJECT 8: Rating of Size A: 6 and Size X: 8*
- SUBJECT 9: Rating of Size A: 4 and Size X: 4*
- SUBJECT 10: Rating of Size A: 6 and Size X: 7*
- SUBJECT 11: Rating of Size A: 6 and Size X: 8*
- SUBJECT 12: Rating of Size A: 6 and Size X: 8*
- SUBJECT 13: 6 for size A and 6 for Size X*
- SUBJECT 14: Rating of 6 for Size A and 8 for Size X*
- SUBJECT 15: 7 for A and 8 for X*
- SUBJECT 16: 7 for A and 8 for X*

PHOTO TEXTURE

- SUBJECT 1: Rating of Size A: 9 and Size X: 9*
- SUBJECT 2: Rating of Size A: 7 and Size X: 7*
- SUBJECT 3: Same*
- SUBJECT 4: Same*
- SUBJECT 5: Same*
- SUBJECT 6: Rating of Size A: 7 and Size X: 9*
- SUBJECT 7: Rating of Size A: 6 and Size X: 9*
- SUBJECT 8: Rating of Size A: 7 and Size X: 9*
- SUBJECT 9: Rating of Size A: 4 and Size X: 4*
- SUBJECT 10: Rating of Size A: 5 and Size X: 7*
- SUBJECT 11: Rating of Size A: 6 and Size X: 8*
- SUBJECT 12: Size A: 7 and Size X: 9*
- SUBJECT 13: Size A: 6 and Size X: 6*
- SUBJECT 14: Size A: 7 and Size X: 7*

14. Please provide your comments on the use of the tunnel in the NASA HDD display concept.

- SUBJECT 1: May have been too many frames when the angle irons appeared. Reduce the rate of the flow of angle irons*
- SUBJECT 2: Was helpful if I was not on ghost aircraft. A little too minimal but may be good for long flights.*
- SUBJECT 3: Same as HUD*
- SUBJECT 4: Same as HUD*
- SUBJECT 5: Same as HUD*
- SUBJECT 6: Same thing as NASA HUD tunnel as long as it doesn't overpower all the other things you are trying to look at it. Good reference cue in addition to other guidance is great but not by itself.*
- SUBJECT 7: Mostly size. The size A even changing 30, 60, 90 and Unity didn't give the same impression and had to keep switching in the X.*
- SUBJECT 8: The Size X Photo was just great. It gave me all the information I needed. However, I would say that the Generic texture gave much better contrast and I could see how it would be an issue on a day when I am flying in the snow and the photo picture looks nothing like the outside world. At least with Generic, I know it is artificial.*
- SUBJECT 9: Just didn't need it with the terrain and ghost aircraft.*
- SUBJECT 10: The tunnel was ok but the small size on A made it difficult to see other symbology and I really didn't need it much since I had the ghost.*
- SUBJECT 11: The FOV of size A made the tunnel difficult to use. Also, I really didn't need to use the tunnel much except with Size A because of difficulty of small FOV needed to see symbology yet increased the chance of getting outside the tunnel.*
- SUBJECT 12: Same as for HUD.*
- SUBJECT 13: The reduced clutter of the HDD was great and it provided just enough detail and look ahead to know when I was going into a turn. Would have liked a TOGA tunnel*
- SUBJECT 14: Same as HUD*
- SUBJECT 15: TOGA Tunnel would have helped.*
- SUBJECT 16: No comments. Liked the tunnel and thought it was helpful but the SVS terrain and FMA was all I really needed.*

15. Please provide any comments on the symbology used in the NASA HDD display concept

- SUBJECT 1: None*
- SUBJECT 2: heading indicator numbers were squished and fuzzy*
- SUBJECT 3: No.*
- SUBJECT 4: No.*
- SUBJECT 5: Wasn't really like the 757 instruments since there is a lot of symbology missing from your display and arranged differently than on the EADI; however, I got used to it and was able to fly what you call the baseline.*
- SUBJECT 6: No*
- SUBJECT 7: Size A was too cluttered. Even though it wasn't integrated it was way too much information on the SVS display. Would like to declutter HDD or dim.*
- SUBJECT 8: Size A was way too cluttered. But, I couldn't use a low FOV because I could not see enough terrain.*
- SUBJECT 9: Tunnel on Size A was distracting.*
- SUBJECT 10: None*
- SUBJECT 11: Size A with larger FOV made the symbology too cluttered (display)*
- SUBJECT 12: really liked the ghost aircraft and could picture it 3D. Liked runway highlight and extended centerline*
- SUBJECT 13: A bank angle cue on the ghost would be helpful*
- SUBJECT 14: None*
- SUBJECT 15: Not really like what I would expect to see for baseline symbology.*
- SUBJECT 16: Symbology was different that I am used to seeing although it wasn't hard to fly.*

16. Please rate the workload associated using each NASA display concept for the Rwy. 07 approach. We can define workload as: “the degree of cognitive processing capacity required to perform the flight task approach adequately”

These are reversed scored with high numbers = lower workload

GENERIC TEXTURE

- SUBJECT 1: Rating of 7 for Size A and 8 for Size X
- SUBJECT 2: Rating of 7 for Size A and 8 for Size X
- SUBJECT 3: Rating of 7 for Size A and 9 for Size X
- SUBJECT 4: Rating of 7 for Size A and 8 for Size X
- SUBJECT 5: Rating of 6 for Size A and 8 for Size X
- SUBJECT 6: Rating of 5 for Size A and 7 for Size X
- SUBJECT 7: Rating of 7 for Size A and 8 for Size X
- SUBJECT 8: Rating of 7 for Size A and 8 for Size X
- SUBJECT 9: Rating of 7 for Size A and 8 for Size X
- SUBJECT 10: Rating of Size A: 7 and Size X was 8
- SUBJECT 11: Rating of Size A: 7 and Size X was 9
- SUBJECT 12: Rating of Size A: 5 and Size X was 6
- SUBJECT 13: Rating of Size A: 6 and Size X was 7
- SUBJECT 14: Rating of 7 for A and 8 for X
- SUBJECT 15: Rating of 6 for A and 9 for X
- SUBJECT 16: Rating of 7 for A and 9 for X

PHOTO TEXTURE

- SUBJECT 1: Rating of 7 for Size A and 8 for Size X
- SUBJECT 2: Rating of 8 for Size A and 8 for Size X
- SUBJECT 3: 8 for A and 9 for X
- SUBJECT 4: 6 for A and 9 for X
- SUBJECT 5: 7 for A and 9 for X
- SUBJECT 6: Rating of 6 for Size A and 8 for Size X
- SUBJECT 7: Same ratings.
- SUBJECT 8: Same
- SUBJECT 9: Same
- SUBJECT 10: Rating of Size A: 7 and Size X: 8
- SUBJECT 11: Same
- SUBJECT 12: Size A was 6 and Size X was 8
- SUBJECT 13: Size A was 7 and Size X was 9
- SUBJECT 14: Same
- SUBJECT 15: 8 for A and 8 for X
- SUBJECT 16: 6 for A and 9 for X

BASEL INE

- SUBJECT 1: Rating of 4
- SUBJECT 2: Rating of 5
- SUBJECT 3: 5
- SUBJECT 4: 6
- SUBJECT 5: 6
- SUBJECT 6: Rating of 3
- SUBJECT 7: Rating of 4
- SUBJECT 8: Rating of 4
- SUBJECT 9: Rating of 3
- SUBJECT 10: Rating of 3
- SUBJECT 11: Rating of 4
- SUBJECT 12: Rating of 3
- SUBJECT 13: Rating of 3
- SUBJECT 14: 3
- SUBJECT 15: 4
- SUBJECT 16: 6

Approach and Missed

HUD Photo	HUD Generic
7	7
6	6
8	8
7	7
8	8
7	6
8	8
9	9
7	7
8	8
6	6
7	8
7	6
8	7
4	4
9	9

Please rate the workload associated using each NASA display concept for the Rwy. 07 missed approach. We can define workload as: “the degree of cognitive processing capacity required to perform the flight task approach adequately”
Reversed Scored

GENERIC TEXTURE

- SUBJECT 1: Rating of 7 for Size A and 8 for Size X*
- SUBJECT 2: Rating of 7 for Size A and 8 for Size X*
- SUBJECT 3: Rating of 7 for Size A and 9 for Size X*
- SUBJECT 4: Rating of 6 for Size A and 7 for Size X*
- SUBJECT 5: Same as for approach*
- SUBJECT 6: Same as for approach.*
- SUBJECT 7: Same*
- SUBJECT 8: Same*
- SUBJECT 9: Rating of 5.*
- SUBJECT 9: Same*
- SUBJECT 10: Same*
- SUBJECT 11: Same*
- SUBJECT 12: Same*
- SUBJECT 13: Same*
- SUBJECT 14: Same*
- SUBJECT 15: Same*
- SUBJECT 16: Same*

PHOTO TEXTURE

- SUBJECT 1: Rating of 7 for size A and 8 for Size X*
- SUBJECT 2: Rating of 8 for Size A and 8 for Size X*
- SUBJECT 3: Rating of 7 for Size A and 8 for Size X*
- SUBJECT 4: Same as approach*
- SUBJECT 5: Same*
- SUBJECT 6: Same*
- SUBJECT 7: Same*
- SUBJECT 8: Same*
- SUBJECT 9: Same*
- SUBJECT 10: Same*
- SUBJECT 11: Same*
- SUBJECT 12: Same*
- SUBJECT 13: Same*
- SUBJECT 14: Same*
- SUBJECT 15: Same*
- SUBJECT 16: Same*

BASEL INE

- SUBJECT 1: Rating of 4*
- SUBJECT 2: Rating of 4*
- SUBJECT 3: Rating of 4*
- SUBJECT 4: Rating of 4*
- SUBJECT 5: Rating of 4*
- SUBJECT 6: Rating of 4*
- SUBJECT 7: Rating of 4*
- SUBJECT 8: Rating of 5*
- SUBJECT 9: Rating of 2*
- SUBJECT 10: Rating of 2*
- SUBJECT 11: Rating of 3*
- SUBJECT 12: Rating of 3*
- SUBJECT 13: Rating of 3*
- SUBJECT 14: Rating of 4*
- SUBJECT 15: Rating of 4*
- SUBJECT 16: Rating of 4*

16. Please evaluate the level of situation awareness experienced during the approach to rwy. 7 for each display concept. We define situation awareness as: "...the pilot has an integrated understanding of the factors that will contribute to the safe flying of the aircraft under normal or non-normal conditions."

Reversed Scored

GENERIC TEXTURE

SUBJECT 1: Rating of 8 for Size A and 9 for Size X
SUBJECT 2: Rating of 7 for Size A and 9 for Size X
SUBJECT 3: Rating of 7 for Size A and 9 for Size X
SUBJECT 4: Rating of 7 for Size A and 8 for Size X
SUBJECT 5: Rating of 6 for Size A and 9 for Size X
SUBJECT 6: Rating of 7 for Size A and 8 for Size X
SUBJECT 7: Rating of 8 for Size A and 9 for Size X
SUBJECT 8: Rating of 7 for Size A and 9 for Size X
SUBJECT 9: Rating of 8 for Size A and 9 for Size X
SUBJECT 10: Rating of Size A: 7 and 9 for Size X
SUBJECT 11: Rating of Size A: 7 and 9 for Size X
SUBJECT 12: Rating of Size A: 7 and 9 for Size X
SUBJECT 13: Rating of Size A: 7 and 8 for Size X
SUBJECT 14: Rating of 6 for Size A and 7 for Size X
SUBJECT 15: Rating of 6 for Size A and 8 for Size X
SUBJECT 16: Rating of 7 for Size A and 9 for Size X

PHOTO TEXTURE

SUBJECT 1: Rating of 8 for Size A and 9 for Size X
SUBJECT 2: Rating of 7 for Size A and 9 for Size X
SUBJECT 3: Rating of 7 for Size A and 9 for Size X
SUBJECT 4: Rating of 7 for Size A and 9 for Size X
SUBJECT 5: Rating of 7 for Size A and 9 for Size X
SUBJECT 6: Rating of 8 for Size A and 9 for Size X
SUBJECT 7: Rating of 8 for Size A and 9 for Size X; really didn't jump out as a difference
SUBJECT 8: Rating of 7 for Size A and 9 for Size X
SUBJECT 9: Rating of 7 for Size A and 9 for Size X
SUBJECT 10: Rating of 7 for Size A and 8 for Size X
SUBJECT 11: Rating of 7 for Size A and 9 for Size X
SUBJECT 12: Rating of 7 for Size A and 8 for Size X
SUBJECT 13: 7 for Size A and 9 for Size X
SUBJECT 14: Rating of 7 for Size A and 9 for Size X
SUBJECT 15: Rating of 6 for Size A and 8 for Size X
SUBJECT 16: Rating of 7 for Size A and 9 for Size X

BASELINE

SUBJECT 1: Rating of 4
SUBJECT 2: Rating of 3
SUBJECT 3: Rating of 4
SUBJECT 4: Rating of 4
SUBJECT 5: Rating of 4
SUBJECT 6: Rating of 5
SUBJECT 7: Rating of 4
SUBJECT 8: Rating of 3
SUBJECT 9: Rating of 4
SUBJECT 10: Rating of 4
SUBJECT 11: Rating of 4
SUBJECT 12: Rating of 4
SUBJECT 13: Rating of 4
SUBJECT 14: Rating of 4
SUBJECT 15: Rating of 5
SUBJECT 16: Rating of 3

17. Please evaluate the level of situation awareness experienced during the missed approach to rwy. 7 for each display concept. We define situation awareness as: "...the pilot has an integrated understanding of the factors that will contribute to the safe flying of the aircraft under normal or non-normal conditions."

GENERIC TEXTURE

- SUBJECT 1: Rating of 8 for Size A and 9 for Size X*
- SUBJECT 2: Rating of 7 for Size A and 9 for Size*
- SUBJECT 3: Rating of 7 for Size A and 8 for Size*
- SUBJECT 4: Rating of 6 for Size A and 8 for Size*
- SUBJECT 5: Rating of 7 for Size A and 9 for Size*
- SUBJECT 6: Same as approach*
- SUBJECT 7: Same*
- SUBJECT 8: Same*
- SUBJECT 9: Same*
- SUBJECT 10: Same*
- SUBJECT 11: Same*
- SUBJECT 12: Same*
- SUBJECT 13: Same*
- SUBJECT 14: Same as approach*
- SUBJECT 15: Same as approach*
- SUBJECT 16: Same*

PHOTO TEXTURE

- SUBJECT 1: Rating of 8 for Size A and 9 for Size X*
- SUBJECT 2: Rating of 7 for Size A and 9 for Size X*
- SUBJECT 3: Same as approach*
- SUBJECT 4: Same*
- SUBJECT 5: Same*
- SUBJECT 6: Same*
- SUBJECT 7: Same*
- SUBJECT 8: Same*
- SUBJECT 9: Same*
- SUBJECT 10: Same*
- SUBJECT 11: Same*
- SUBJECT 12: Same*
- SUBJECT 13: Same*
- SUBJECT 14: Same*
- SUBJECT 15: Same*
- SUBJECT 16: Same*

BASELINE

- SUBJECT 1: Rating of 4*
- SUBJECT 2: Rating of 2*
- SUBJECT 3: Rating of 2*
- SUBJECT 4: Rating of 4*
- SUBJECT 5: Rating of 3*
- SUBJECT 6: Rating of 2*
- SUBJECT 7: Rating of 2*
- SUBJECT 8: Rating of 2*
- SUBJECT 9: Rating of 2*
- SUBJECT 10: Rating of 2*
- SUBJECT 11: Rating of 2*
- SUBJECT 12: Rating of 2*
- SUBJECT 13: Rating of 3*
- SUBJECT 14: Rating of 2*
- SUBJECT 15: Rating of 3*
- SUBJECT 16: Rating of 3*

HUD Photo	HUD Generic
8	6
8	6
8	8
7	7
9	6
7	6
8	8
9	6
7	7
8	8
6	7
8	8
7	6
8	7
6	4
9	7

18. Please provide any comments that would be helpful to us in evaluating the difference terrain-textures options for the display concept

SUBJECT 1: Preferred photo but generic was acceptable. Definitely better than baseline
SUBJECT 2: Photo was better but the lack of peripheral cues was a negative
SUBJECT 3: Photo was superior although the generic did let you see things faster like rivers
SUBJECT 4: Picking out cultural features was easier with generic although photo was much better to look at
SUBJECT 5: You should look at combining the best features of both!
SUBJECT 6: None
SUBJECT 7: The photo allowed for normal expectations of what the normal terrain would be. Had to interpret the color codings but was minimal.
SUBJECT 8: Contrast was much better with Generic.
SUBJECT 9: Same as for HUD
SUBJECT 10: The generic made it easier to see features like a river or the valley floor.
SUBJECT 11: Photo was really nice, but I could imagine that generic would be better for quickly locating key terrain or cultural features especially with EGE since it is a visual contact approach.
SUBJECT 12: The Photo has so much better pixel quality that it really gives you a lot of confidence that you were safe and knew exactly where the terrain is. But, the generic was pretty good and if cost was a factor then it would be acceptable and much better than EADI.
SUBJECT 13: Depth perception was not as good with Generic texture.
SUBJECT 14: Depth perception and lack of cues with generic
SUBJECT 15: Both were very good although the photo was my choice
SUBJECT 16: Just liked the photo better. It had more cues and I felt like I could really use the display to ensure terrain separation. The generic is good if you stayed with published approach but not as good if you got into trouble. Both are very much better than baseline which was not good at all relatively speaking.

19. Please rate which display concept you would prefer to use to make approach to rwy. 7

SUBJECT 1: Size A Photo, Size X Photo, Size X photo, Size X generic, and Size X generic. Liked the larger size better than Photo.
SUBJECT 2: Size A Photo, Size X Photo, Size X Photo, Size X generic, and Size X generic. Large size better than Photo.
SUBJECT 3: Size A Photo, Size X Photo, Size X Photo, Size X generic, and Size X generic. Large size better than Photo.
SUBJECT 4: Size A Photo, Size X Photo, Size X Photo, Size X generic, and Size X generic. Large size better than Photo.
SUBJECT 5: Size A Photo, Size X Photo, Size X Photo, Size X generic, and Size X generic. Large size better than Photo.
SUBJECT 6: Size A Photo, Size X Photo, Size X Photo, Size X generic, and Size X generic. Large size better than Photo
SUBJECT 7: Size A Photo, Size X Photo, Size X Photo, Size X generic, Size X generic. Photo versus generic minimal
SUBJECT 8: Size A Photo, Size X Photo, Size X Photo, Size X generic, Size X generic. Size and generic was no contest to Size A photo.
SUBJECT 9: Size A photo, size x photo, size x photo, size x generic, size x generic. Size major factor.
SUBJECT 10: Size A photo, size x photo, size x photo, size x generic, size x generic. Size major factor
SUBJECT 11: Size A photo, Size x photo, size x generic, size x generic, size major fact
SUBJECT 12: Size A photo, size x photo, size x generic, size x generic, size major factor.
SUBJECT 13: Size A photo, size x photo, size x generic, size x generic, size major factor
SUBJECT 14: Size A Photo, Size X Photo, Size X Photo, Size X generic, and Size X generic. Large size better than Photo.
SUBJECT 15: Size A Photo, Size X Photo, Size X Photo, Size X generic, and Size X generic. Large size better than Photo.
SUBJECT 16: Size A Photo, Size X Photo, Size X Photo, Size X generic, and Size X generic. Large size better than Photo.

VERTICAL SITUATION DISPLAY

20. On a scale of 1 to 10, please rate how much your situation awareness was increased with the vertical situation display provided during your approach to rwy. 7 using the baseline EADI.

Approach rwy 07 using the baseline EADI

SUBJECT 1: Rating of 5
SUBJECT 2: Rating of 6
SUBJECT 3: Rating of 5
SUBJECT 4: Rating of 5
SUBJECT 5: Rating of 5
SUBJECT 6: Rating of 6
SUBJECT 7: Rating of 6
SUBJECT 8: Rating of 8
SUBJECT 9: Rating of 0
SUBJECT 10: Rating of 6
SUBJECT 11: Rating of 10
SUBJECT 11: Rating of 6
SUBJECT 12: Rating of 9
SUBJECT 13: Rating of 8
SUBJECT 14: Rating of 7
SUBJECT 15: Rating of 7
SUBJECT 16: Rating of 5

Missed Approach rwy. 07 using the baseline EADI

SUBJECT 1: Rating of 5
SUBJECT 2: Rating of 5
SUBJECT 3: Rating of 5
SUBJECT 4: Rating of 6
SUBJECT 5: Rating of 6
SUBJECT 6: Rating of 8
SUBJECT 7: Rating of 6
SUBJECT 8: Rating of 8
SUBJECT 9: Rating of 0
SUBJECT 10: Rating of 6
SUBJECT 11: Rating of 10
SUBJECT 11: Rating of 6
SUBJECT 12: Rating of 5
SUBJECT 13: Rating of 5
SUBJECT 14: Rating of 6
SUBJECT 15: Rating of 8
SUBJECT 16: Rating of 6

Please provide your reason for the rating provided below:

SUBJECT 1: I wasn't that comfortable with using it, but it definitely enhanced the TAWS since it was a red box on the go-around when got close to the terrain. The VSD allowed me to be sure that I was ok.

However, I still was uncomfortable and there is no way I would rely on that in my aircraft alone. I would have been really uncomfortable with what I was seeing in the baseline condition.

SUBJECT 2: The VSD gave some indication that the TAWS was exactly showing me the right information. I did notice that I had to be careful and look at my ND range and think about where the red box from the HSI EGPWS was on the vertical ND.

SUBJECT 3: The VSD gave me a profile view of the TAWS which was not very helpful on the miss because it was always showing me that I was in danger of hitting terrain. The VSD on the other hand let me know that I was ok and that the notch was still there.

SUBJECT 4: I didn't use it as much as I probably should have. With practice, I can see the VSD being a great cross-check instrument.

SUBJECT 5: VSD was not help at all on approach, but on the miss it did give me an indication that what the TAWS was telling (and not telling me) was correct. However, not even close a comparison with SVS.

SUBJECT 6: For approach it helps a little, but the missed really helps to minimize the impact of the red squares.

SUBJECT 7: With the baseline, it gives some immediate SA to determine if I am going to tie the "low level record"

SUBJECT 8: The VSD helps significantly with the baseline. It just gives different information that I can use with regard to terrain out there. The TAWS is nice but it was flashing red at the end of the miss and I could use the VSD to say to myself that I had sufficient terrain clearance.

SUBJECT 9: The VSD provides nothing the TAWS doesn't.

SUBJECT 10: The VSD gave a correlation to the TAWS to help cross-reference. It gave a view of what terrain was right in front of the airplane.

SUBJECT 11: You were flying right into red and therefore it helped to confirm what you knew from the training that there was notch out there that the TAWS system wasn't picking up

SUBJECT 12: Single source of terrain information from TAWS and VSD allows cross-checking and backup of terrain information

SUBJECT 13: There is no way to know with TAWS that you are ok the VSD gave a "huge help".

SUBJECT 14: Another piece of information to help build a 3D model of what is out there, the VSD adds considerably to the TAWS. The VSD gives more of a gradient of the terrain more so than the TAWS

SUBJECT 15: Rating would have been higher perhaps had I been able to use it but I was so focused on the command bars with baseline that I wasn't able to take full advantage of the display and what it could offer me.

SUBJECT 16: Did help. The GPWS displays are integrated like these are and that is why it helps more than say no help at all.

21. On a scale of 1 to 10, please rate how much your situation awareness was increased with the vertical situation display provided during your approach to rwy. 7 using the SVS Size X.

Approach rwy 07 using Size X

SUBJECT 1: Rating of 0

SUBJECT 2: Rating of 2

SUBJECT 3: Rating of 0

SUBJECT 4: Rating of 0

SUBJECT 5: Rating of 0

SUBJECT 6: Rating of 3

SUBJECT 7: Rating of 3

SUBJECT 8: Rating of 2

SUBJECT 9: Rating of 0

SUBJECT 10: Rating of 5

SUBJECT 11: Rating of 3

SUBJECT 12: Rating of 5

SUBJECT 13: Rating of 5

SUBJECT 14: Rating of 2

SUBJECT 15: Rating of 5

SUBJECT 16: Rating of 0

Missed Approach rwy. 07 using Size X

SUBJECT 1: Rating of 0

SUBJECT 2: Rating of 2

SUBJECT 3: Rating of 0

SUBJECT 4: Rating of 0

SUBJECT 5: Rating of 0

SUBJECT 6: Rating of 4

SUBJECT 7: Rating of 3

SUBJECT 8: Rating of 2

SUBJECT 9: Rating of 0

SUBJECT 10: Rating of 5

SUBJECT 11: Rating of 3

SUBJECT 12: Rating of 5

SUBJECT 13: Rating of 5

SUBJECT 14: Rating of 2

SUBJECT 15: Rating of 5

SUBJECT 16: Rating of 0

Please provide your reason for the rating provided below:

SUBJECT 1: Everything I was seeing in the PFD display was in the other displays. However, the PFD gave me better SA and honestly I didn't even look at the vertical display.

SUBJECT 2: It certainly doesn't hurt to have that information available to you.

SUBJECT 3: Not really needed.

SUBJECT 4: VSD can give you a different perspective and perhaps it easier to quickly discern but since SVS was so good I didn't really even use or need to use it.

SUBJECT 5: Wasn't part of my scan when I had SVS.

SUBJECT 6: The reason is obvious when you can peak out and see terrain the VSD doesn't have as much impact on SA. The simulated vision is a much accurate depiction of what is actually happening.

SUBJECT 7: There is so much additional information in the SVS that the VSD doesn't add much

SUBJECT 8: Well, the information adds a little so I gave it a 2 but in reality I probably could get all the information I needed with the Size X display.

SUBJECT 9: You know, there just wasn't any useful information being given in the display as what I was seeing in the ND and synthetic PFD

SUBJECT 10: Cross-check for the TAWS and the VSD. Nice to have the terrain.

SUBJECT 11: Great cross-check. Without the VSD, however, I would have been as confident

SUBJECT 12: You have terrain information with SVS and TAWS but couldn't hurt to have more terrain information

SUBJECT 13: Good instrument to cross-check but SVS gave you what you need and it is an excellent display at it is. Liked the VSD but would pay more for SVS.

SUBJECT 14: SVS captures everything that the VSD. The VSD gave a little easier look ahead as to how the terrain gradient looks. The VSD gives you the distance to terrain better than SVS where it is a little difficult to tell how far the terrain.

SUBJECT 15: Time to go". With the SVS being 3D, the VSD gives the 4th dimension of time. This is what is coming next and this is how much time to respond to what the symbology is telling me or that I am ok.

SUBJECT 16: Didn't even use it. No help.

22. Please rate how much increased situation awareness the vertical situation display provided during your approach to rwy. 7 using the SVS Size A.

Approach to rwy 7 using the SVS Size A

SUBJECT 1: Rating of 0
SUBJECT 2: Rating of 4
SUBJECT 3: Rating of 3
SUBJECT 4: Rating of 3
SUBJECT 5: Rating of 2
SUBJECT 6: Rating of 4
SUBJECT 7: Rating of 3
SUBJECT 8: Rating of 3
SUBJECT 9: Rating of 0
SUBJECT 10: Rating of 6
SUBJECT 11: Rating of 6
SUBJECT 12: Rating of 6
SUBJECT 13: Rating of 6
SUBJECT 13: Rating of 2
SUBJECT 14: Rating of 2
SUBJECT 15: Rating of 5
SUBJECT 16: Rating of 2

Missed Approach rwy. 07 using Size A

SUBJECT 1: Rating of 0
SUBJECT 2: Rating of 4
SUBJECT 3: Rating of 3
SUBJECT 4: Rating of 3
SUBJECT 5: Rating of 2
SUBJECT 6: Rating of 5
SUBJECT 7: Rating of 5
SUBJECT 8: Rating of 3
SUBJECT 9: Rating of 0
SUBJECT 10: Rating of 6
SUBJECT 11: Rating of 6
SUBJECT 12: Rating of 5
SUBJECT 13: Rating of 6
SUBJECT 14: Rating of 2
SUBJECT 15: Rating of 5
SUBJECT 16: Rating of 3

Please provide your reason for the rating provided below:

SUBJECT 1: *I would say the same reason as for Size X. Just didn't need it.*

SUBJECT 2: *Well, it did help with the smaller display especially when I was in 60 FOV. Hard to pick out the terrain in the Size A with large FOV*

SUBJECT 3: *Because the size A doesn't have integrated symbology, it was easier to move the VSD in to scan and I found that it was helpful because of the small FOV of the Size A*

SUBJECT 4: *FOV of Size A is so small and minified with 60 FOV that the VSD did supplement the information presentation on SVS instrument that I didn't need with Size X*

SUBJECT 5: *Size X was larger and I could see more terrain. It wasn't as minified as I saw with Size A. I wanted to leave Size A in 30 on miss but the VV kept getting pegged. But when I went to 60, the scene was less useful on size A whereas it was still ok on Size X. Therefore, the TAWS and VSD became more valuable to me.*

SUBJECT 6: *Smaller size has less SA with just SVS so VSD helped a little more than X*

SUBJECT 7: *If both pilots are going to have it, the PNF can use it to reference during miss*

SUBJECT 8: *Same reason but Size A is not as good for SA so having the VSD would be nice to have.*

SUBJECT 9: *Again, no information that I couldn't get from the other displays. I didn't even look at it.*

SUBJECT 10: *The terrain was so compressed and hard to see; cluttered.*

SUBJECT 11: *SA for terrain was excellent and the VSD provided additional check on terrain clearance.*

SUBJECT 12: *Same*

SUBJECT 13: *More advantageous since you don't get a strong sense of terrain awareness that you get with Size X*

SUBJECT 14: *Same as Size X*

SUBJECT 15: *Same*

SUBJECT 16: *Didn't really use it all. Some cross check but I can see how it could be somewhat helpful but SVS is so much better than it really isn't useful.*

23. On a scale of 0 to 100, please indicate your assessment of the % added by the VSD in terms of safety improvement for the following display concepts:

EADI w/ TAWS:

- SUBJECT 1: 35%
- SUBJECT 2: 50%
- SUBJECT 3: 40%
- SUBJECT 4: 50%
- SUBJECT 5: 50%
- SUBJECT 6: 40%
- SUBJECT 7: 30%
- SUBJECT 8: 35%
- SUBJECT 9: 0%
- SUBJECT 10: 70%
- SUBJECT 11: 60%
- SUBJECT 12: 60%
- SUBJECT 13: 70%
- SUBJECT 14: 70%
- SUBJECT 15: 70%
- SUBJECT 16: 50%

SIZE X:

- SUBJECT 1: 10%
- SUBJECT 2: 30% (*doesn't hurt to have I guess*)
- SUBJECT 3: 10%
- SUBJECT 4: 10%
- SUBJECT 5: 10%
- SUBJECT 6: 20%
- SUBJECT 7: 10%
- SUBJECT 8: 15%
- SUBJECT 9: 0%
- SUBJECT 10: 0%
- SUBJECT 11: 10% *maybe*
- SUBJECT 12: 15%
- SUBJECT 13: 20%
- SUBJECT 14: 10%
- SUBJECT 15: 20%
- SUBJECT 16: 0%

SIZE A:

- SUBJECT 1: 10%
- SUBJECT 2: 30%
- SUBJECT 3: 20%
- SUBJECT 4: 20%
- SUBJECT 5: 25%
- SUBJECT 6: 25%
- SUBJECT 7: 15%
- SUBJECT 8: 15%
- SUBJECT 9: 0%
- SUBJECT 10: 60%
- SUBJECT 11: 15%
- SUBJECT 12: 20%
- SUBJECT 13: 30%
- SUBJECT 14: 20%
- SUBJECT 15: 20%
- SUBJECT 16: 0%

24. If the CFIT was not detected, what was lacking in situation awareness?

SUBJECT 1: Didn't detect and didn't think SA was lacking. Just saw bright red like every other run and assumed all was ok. He did see RA come on, but it was too late then.

SUBJECT 2: N/A detected CFIT

SUBJECT 3: N/A

SUBJECT 4: No detection. TAWS didn't change and wasn't using the VSD as much as I should have

SUBJECT 5: N/A

SUBJECT 6: N/A

SUBJECT 7: N/A

SUBJECT 8: N/A

SUBJECT 9: N/A

SUBJECT 10: N/A

SUBJECT 11: N/A

SUBJECT 12: N/A

SUBJECT 13: N/A

SUBJECT 14: N/A

SUBJECT 15: N/A; magenta line shifted over to the left about .5 mile.

SUBJECT 16: Did notice it until the very end.

25. At what point in the experimental run, did you notice a problem and possible CFIT encounter (i.e., position, time, event, etc.)?

SUBJECT 1: N/A

SUBJECT 2: 20-30 seconds

SUBJECT 3: Hard to say. I definitely knew something was wrong about 1/2 way through the miss

SUBJECT 4: N/A

SUBJECT 5: About 2 miles before I went through the notch in the terrain

SUBJECT 6: 9.9 DME; had intersected the 059 radial and then kept drifting further and further left so knew something was wrong

SUBJECT 7: 10.4 DME stated something was wrong. The death dot went below the mountain range and then knew without really having to look at other information.

SUBJECT 8: After making the turn to the left and nothing seemed abnormal but on the right turn saw velocity vector on terrain and then looked at VSD and knew something was wrong. After noticing hey I wasn't going to miss terrain, initiated the standard recovery maneuver (target is 15 pitch).

SUBJECT 9: That was strictly due to the photo terrain display.

SUBJECT 10: 5 nm from terrain could see the commanded flight director was taking me into the terrain.

SUBJECT 11: 6 nm from go around I could tell

SUBJECT 12: 8.2 DME

SUBJECT 13: 11.4 DME but wasn't really sure that there was a CFIT but knew something was up and normally wouldn't have flown to such red in ANY OF THE RUNS. So, although he said something just before CFIT, he was unaware that there was actually a potential of a CFIT but rather knew something was a little different but not sure "exactly what I was feeling" A gut reaction.

SUBJECT 14: 10.8 DME I knew something is wrong. The VSD gave me the best information but without SVS I really couldn't be sure. I got the feeling much earlier than when I said so but SVS I couldn't tell how far but I knew something was wrong. The VSD confirmed it for me.

SUBJECT 15: Around the last right turn.

SUBJECT 16: N/A

26. Which instrument alerted you to the possible CFIT?

SUBJECT 1: N/A

SUBJECT 2: SVS --- noticed was left of course then I looked at VSD to confirm and knew it for sure when I saw the orange wedge

SUBJECT 3: SVS without a doubt. VSD helped to confirm

SUBJECT 4: N/A

SUBJECT 5: SVS

SUBJECT 6: SVS definitely without a doubt; RMI was last and the 1 degree it was impossible to tell that it was different

SUBJECT 7: SVS no doubt about it. VSD was nice to cross-check

SUBJECT 8: TAWS first alerted something was not right. Then SVS of course to check and saw velocity vector was on terrain that told me that this wasn't the usual red I have seen on the last 21 runs. Couldn't see the valley on the HUD so my course guidance must be off.

SUBJECT 9: SVS definitely.

SUBJECT 10: SVS first, then shortly thereafter the TAWS. Problem with TAWS is that it is always bright red but you could see with the trace (noodle) that it was on a path to terrain.

SUBJECT 11: VSD but the SVS told me what to do gave me an option.

SUBJECT 12: SVS; I couldn't see that the notch was way off to the right. TAWS was last but VSD really helped in combination to confirm SVS display

SUBJECT 13: TAWS. VSD didn't come into decision making instead was focused on TAWS

SUBJECT 14: SVS first but VSD confirmed it for me.

SUBJECT 15: SVS first with the cross-check with TAWS and VSD

SUBJECT 16: N/A

27. Did you feel you had enough information to safely avoid the terrain? a. Prior to first noticing the CFIT?

SUBJECT 1: N/A

SUBJECT 2: Went above terrain at about 410 feet and avoided. Felt was a little late in seeing terrain and avoiding but could do so.

SUBJECT 3: The SVS display lets you see the terrain well before it becomes a danger. However, it was a little hard to determine how far but with repeated times flying it, I was in tune with the distance

SUBJECT 4: N/A

SUBJECT 5: Without SVS there would have been very little change of me being able to discover that something was up. However, because SVS gives you such an intuitive image you can't help but notice that something was wrong. Forget the RMI it was no help and no one uses it anyway. VSD could be useful but it will require a lot of training. I noticed that once I came close the VSD started giving me an indication that everything was ok again. Not very good presentation of dangerous terrain. It should highlight, beep, .lightup....something instead of showing some yellow 5 miles away and then the peak disappears when you come up close to the terrain.

SUBJECT 6: Yes.

SUBJECT 7: Yes

SUBJECT 8: Yes.

SUBJECT 9: Yes. With a photo HUD I may have caught it sooner but the RA and photo depiction let me know

SUBJECT 10: The SVS display gave excellent terrain information which allowed me to manage my path and energy to safely avoid the terrain

SUBJECT 11: VSD alerted and the SVS gave the guidance on what to do that the VSD doesn't

SUBJECT 12: Early alert and avoided the terrain.

SUBJECT 13: No. Honestly, I would have turned right but given the distance to contact it would have been possible but not sure.

SUBJECT 14: Yes.

SUBJECT 15: Felt I could get over the peak so I didn't need to laterally miss the terrain since I knew that I could fly over it and so I was sure that I was going to be ok.

SUBJECT 16: N/A

28. Upon noticing a potential CFIT?

SUBJECT 1: N/A

SUBJECT 2: Yes

SUBJECT 3: Yes.

SUBJECT 4: N/A

SUBJECT 5: Yes.

SUBJECT 6: Yes; it was definitely the SVS and everything looked good but it was clear that something was wrong on the SVS display. I think that everyone who didn't get vision would hit the mountain without a doubt. I don't see how you could not hit it given how compelling and subtle the error is.

SUBJECT 7: Yes.

SUBJECT 8: Yes. After 20 in a row, it obviously looked wrong.

SUBJECT 9: Yes.

SUBJECT 10: Yes.

SUBJECT 11: Yes

SUBJECT 12: Yes

SUBJECT 13: Again Yes and No given the difficult of discriminating versus other runs that were similar

SUBJECT 14: Really appreciated the SVS compared to the baseline for avoiding the terrain. The VSD also was great and helped significantly.

SUBJECT 15: I think so.

SUBJECT 16: N/A

29. What is your best estimate of the closest approach to terrain that you experienced during the last experimental run with the CFIT encounter?

SUBJECT 1: N/A

SUBJECT 2: 250 feet because of orange wedge indication

SUBJECT 3: 200 feet

SUBJECT 4: N/A

SUBJECT 5: 500 feet

SUBJECT 6: 1200 feet vertical; maybe .25 laterally

SUBJECT 7: Within 200 feet but knew I was going to clear it.

SUBJECT 8: Run stopped but I was 1000 ft RA

SUBJECT 9: About 250 feet.

SUBJECT 10: About 5 DME noticed the terrain.

SUBJECT 11: Well above terrain when scenario stopped.

SUBJECT 12: 1000 feet

SUBJECT 13: 7500 feet and looked like I was right on top of the mountain.

SUBJECT 14: 1000 feet laterally

SUBJECT 15: Right around 300 feet vertically

SUBJECT 16: N/A

30. What were the disadvantages / advantageous of the display condition for the CFIT detection?

SUBJECT 1: N/A

SUBJECT 2: Would really like to have an indication on PFD showing MSA (i.e., a number on a peak)

SUBJECT 3: SVS with the VV lets me know well ahead of the terrain that if I continue on the path I am on I was going to hit the mountain; no disadvantages except that it would be nice to be able to tell how high the mountain is

SUBJECT 4: N/A

SUBJECT 5: Excellent display. I would suggest that some indication needs to be in the PFD to help make the connection with the ND. I found myself looking at the EGPWS and seeing red but not really sure exactly what peaks were what. Sure, I knew that the green wedge was telling me what my FOV on the PFD but it did take some extra mental steps. Also, having MSA, terrain elevation information, etc. would help. Maybe a combination of generic and photo would be best to give the best of what both have to offer

SUBJECT 6: Pilots don't fly into mountains they see

SUBJECT 7: It was good. The fact that the velocity vector was indicating the path and the photo texture was well enough defined that I recognized that the flight path. Enough information to make accurate assessment.

SUBJECT 8: Having the terrain was a big advantage. That allowed me to at least process hey something is not right and to avoid all I had to do was put the velocity vector. The TAWS and VSD tells me something is wrong but the SVS can cross check and in addition and very significant give me the escape guidance I need to avoid terrain.

SUBJECT 9: Huge advantage to CFIT detection and it certainly avoided what would have been an accident.

SUBJECT 10: It showed you the real world picture of where the aircraft was headed even though you couldn't see outside. It was excellent and I really got high SA using the display.

SUBJECT 11: The real positive is if something is not right it gives you the information you need to remain safe. If you got the baseline and everything is working just fine, but as soon as something goes wrong SVS really pays off.

SUBJECT 12: flight director was smaller and less terrain information but there was enough information to discover that the path was incorrect. Size X would have been better but Size A was adequate.

SUBJECT 13: Huge advantage to CFIT detection and it certainly avoided what would have definitely been an accident...the SVS allowed me to see the picture of what was happening that the VSD and TAWS was telling me. Pull up, stupid yet without the SVS it would have been hard to say "yes, I'm off path and I am going to go into the mountain". A picture may be worth a thousand words, but with synthetic vision it is more like it is worth a thousand lives!

SUBJECT 14: The SVS allowed me to see the picture of what was happening that the VSD and TAWS was telling me. Pull up, stupid yet without the SVS it would have been hard to say yes, I'm off path and I am going to go into the mountain. A picture is worth a thousand words, or better, a thousand lives!!

SUBJECT 15: Liked that you could correlated MSAs on SVS with Jeppesen. On GA mode, putting MSA on display would be very helpful. Combined with a EGPWS, it would be a complete package and no disadvantages.

SUBJECT 16: N/A

Appendix G: Pilot Responses to Post experiment Questionnaire

1. Please discuss which display concept that you experienced which provided the most enhanced situation awareness in making the missed approach at EGE?

SUBJECT 1: The Photo Realistic View by far provided the greatest margin of safety. In fact was solely responsible for completing the maneuver safely.

SUBJECT 2: Size X with photo realistic. Size matters. It was easier than Size A and the color was better than the HUD.

SUBJECT 3: HUD – with the ground depiction allowed for ease of transition for scan.

SUBJECT 4: The Size X with photo realistic terrain provided the most awareness since I could expand field of view with a high pitch attitude.

SUBJECT 5: Overall, I would say the X size Photo realistic. The HUD might work well also ie when you break out on the approach or when ever you see the real terrain.

SUBJECT 6: Both the HUD and HDD were great when presented with terrain info. The terrain info, even a small bit of info was helpful.

SUBJECT 7: The “HUD Photo” provided me the best SA because of its 1 to 1 real and correctly positioned image. I would prefer color HUD image with enhancement capability (i.e. draw a runway outline that is enhanced) or enhance significant objects like towers or highest mountain peaks.

SUBJECT 8: Size X. Better overall display for SA when used with vertical situation display.

SUBJECT 9: In most cases I felt the X size display with photo realistic gave me greater SA. Sometimes (emphasis) the HUD display would momentarily be hidden (green on green).

SUBJECT 10: The best presentation was the “Size X – photo realistic”. It provided the most realistic info in an easy, format of sufficient size.

SUBJECT 11: NASA Size X HDD provided highest level of SA. The terrain portrayal and size were key SA builders. No real difference for photo or generic terrain.

SUBJECT 12: Size X with photo realistic terrain

SUBJECT 13: Size X photo realistic provided the most SA due it’s ability to replicate the “outside world” the best.

SUBJECT 14: I preferred the Size X generic display. Selecting wider ranges when in close proximity to terrain gave a reassurance that lowered tension while flying toward rising terrain.

2. Please comment on the NASA PFD display concepts and what you particularly liked and thought were the most salient features for improving safety, performance and enhancing your situation awareness

SUBJECT 1: The Size X Display combined with a photo realistic display were huge advantages.

SUBJECT 2: Again, Size X. Although a HUD in the later stages (Last 60 seconds before touchdown) would help too.

SUBJECT 3: (no comments)

SUBJECT 4: Photo realistic and generic terrain overlays were great for maintaining SA. VSD is a great enhancement that gives accurate distance of upcoming terrain.

SUBJECT 5: The HUD and large PFD worked well in giving you a heads up when turns and descents were upcoming.

SUBJECT 6: I liked the Size X concept the best in both HUD and HDD, it was more helpful and easier to comprehend data. The versions with photo realistic detail were the greatest asset. Generic data seemed poorest on SA.

SUBJECT 7: The Size X was the best heads down, followed by Size "A". I would actually prefer a combination generic view – when up and away from the ground (because definition is better than photo) and use photo real below a certain altitude say 1000' or 500'. This would also alert you to "You are getting close to the ground". See #22 for continuation.

SUBJECT 8: Size X with VSD package, tunnel for better "down stream" SA, ghost airplane easier to follow than current 2 bar baseline system.

SUBJECT 9: These display overall were outstanding. Easiest to use in a quick glance for terrain clearance was the VSD. HUD display was exceptional SA on last run where NAV system was "off".

SUBJECT 10: The best feature was the terrain info. Followed by the "flying triangle" flight director.

SUBJECT 11: The terrain portrayal was the key to improving SA and safety. The crow's feet tunnel was nice to have.

SUBJECT 12: photo realistic terrain depiction on all of the different displays

SUBJECT 13: All the displays except the baseline provided good guidance, situational awareness through the terrain displays and intuitive feedback on the aircraft state. All the things necessary to complete a successful flight. Best features would be the photo realism, ghost a/c guidance with velocity vector.

SUBJECT 14: Guidance/track projections superimposed on 3D depictions of terrain and cultural features increased situation awareness and comfort levels. Would greatly aid contact approaches in marginal conditions.

3. Please comment on the NASA HUD display concepts and what you particularly liked and thought were the most salient features for improving safety, performance and enhancing your situation awareness

SUBJECT 1: I prefer the HUD for transitioning from instrument flying to flying by strictly visual references. As in transition to landing from an approach to minimums. Although this couldn't be proven in this particular experiment.

SUBJECT 2: Any HUD is a tremendous improvement. The NASA HUD is well designed and well laid out.

SUBJECT 3: Relative vertical positions is easily determined.

SUBJECT 4: Terrain overlay on the HUD allows pilot to view the big picture while keeping eyes outside of aircraft. HUD allows for quicker crosscheck of aircraft performance compared to PFD.

SUBJECT 5: Great out the window SA no need to look inside for info. Will work great in landing transition environment.

SUBJECT 6: The terrain feature was great, and probably a greater asset at night when easier to look at and no terrain is visible.

SUBJECT 7: The biggest enhancement is seeing where you are (FPV) and the real world image. Nothing is more compelling than seeing the mountain. People will fly into red (because of all the false warnings they have seen in years of flying – but they will never fly into a picture of a mountain).

SUBJECT 8: All the good things of the PFD with a Heads Up and out of the cockpit for better traffic and outside world SA.

SUBJECT 9: The tunnel depiction was very good for placement on the curved approach to final. Also ghost aircraft was helpful.

SUBJECT 10: The HUD concept offers time critical info from the most useful location for the flying pilot.

SUBJECT 11: The terrain portrayal was the key to improved SA and safety.

SUBJECT 12: photo realistic terrain

SUBJECT 13: The guidance program is good. The terrain provides additional situation awareness but doesn't have the impact of the photo realistic displayed on the PFD display.

SUBJECT 14: HUD concept would be especially useful for retrofit into non-glass flight deck applications. Heads-up feature should be especially useful when flying/transitioning in and out of clouds and haze.

4. Please discuss any crew coordination or operational issues that you think may be a problem with using the SV displays (especially the HUD).

SUBJECT 1: A single display HUD without adequate instrumentation on the FO's (first officer's) side is contrary to the latest CRM Philosophy.

SUBJECT 2: If captain (only) has HUD. FO will need something to be able to accurately back him up. Flight director & magenta line at a minimum.

SUBJECT 3: Very little as far as problems

SUBJECT 4: With terrain overlay, the HUD can become very crowded with information. However, each pilot and situation are different so I prefer as much info displayed as possible but have the option to de-clutter the HUD.

SUBJECT 5: For those who have flown a HUD or used NUG's you must remember you are not looking at real-time terrain but generated terrain.

SUBJECT 6: Depending upon night or day operation it may be best to offer one pilot terrain info on the HUD while the other pilot the same terrain info on the HDD.

SUBJECT 7: It is obviously best if both crewmembers have a HUD. A repeater heads down is second best and no HUD or repeater for second pilot is of little value.

SUBJECT 8: Because of increased ability to do things that were beyond a comfort level in the past – more intra-crew communication must exist to alleviate questions like “Where are you going?” or “What are you doing?”

SUBJECT 9: Crew coordination problems WILL occur if only 1 pilot has a HUD. And without a good battery of other items (VSD & ND with generic or photo realistic)

SUBJECT 10: Airline operations require the flying pilot to go heads up on final. An effective system would therefore require both HUD and HDD for both pilots to have the same info at “Low levels”

SUBJECT 11: Not all info required is on the HUD and to get all required information inside instruments needed to be checked.

SUBJECT 12: Unless the HUD is installed at both pilot stations thus no-terrain reference backup if one fails. Switching FOV or other features will add to workload of pilot not flying who is already involved in other tasks such as setting up flt data or his side & ATC communications.

SUBJECT 13: Operationally the need to change the FOV during the go around is a problem. The last thing a pilot needs is to lose the guidance cues or have a difficult time seeing them during a high workload task.

With the HUD, if only one is on the flight deck (as done on today's ops) it is imperative the other pilot has ALL the same cues and guidance as the pilot with the HUD.

SUBJECT 14: With a crew application, it would be important to ensure both crew members were referencing the same scale as guidance appeared different at different ranges. With HUD, might want to have on with and on without HUD.

5. Please comment on the “opaqueness” of the NASA HUD concept. What are your opinions on its operational safety and benefits of having a synthetic terrain on the HUD? Please provide your opinion with the acknowledgement that you may have only seen the HUD in the simulator.

SUBJECT 1: Can you put a photo realistic display on a HUD? The HUD presents limitations in contouring I assume is due to the “see through” requirement. Without further testing my opinion is Size X with photo realistic (PR) would be preferred for general use over the HUD.

SUBJECT 2: This is an issue. Must have a method to transition to outside – unless this is planned/intended to go into a zero-zero field.

SUBJECT 3: (no comments)

SUBJECT 4: Having terrain display in the HUD is an enhancement even though it is opaque. It provides a crucial element of pilot awareness to his environment. It is good enough for airline/commercial aircraft.

SUBJECT 5: Good SA enhancer. Need to be able to have the synthetic terrain go away when you can actually see the ground.

SUBJECT 6: I’ve used the HUD many times before and find it an awesome asset and the terrain feature is a definite plus. Perhaps the ability to use or not use it depending upon the situation is my only operational suggestion.

SUBJECT 7: I have flown the F-16 LATIRN (IR image) HUD at night. If it is adjusted correctly it is no problem, you see the projected image over the top of the real world and when real world is viewable you see real world.

SUBJECT 8: While Photo would be the preferred display – even generic provides enough detail to provide better SA. Would feel better about critiquing the HUD after seeing how it looks (in the) real world in VMC conditions – It may be too much to look at if operating conducted with ground contact visually.

SUBJECT 9: I used a HUD in the USAF for nearly 20 years. The NASA HUD was exceptional for SA. Some minor changes may be needed to add contrast and/or warning messages to be totally head’s out.

SUBJECT 10: Opaqueness could be a problem without contrast and brightness (terrain) controls.

SUBJECT 11: Could be a problem, but not likely. Should be implemented so it could be moved out of the way during VFR conditions possibly.

SUBJECT 12: Having the terrain depicted on the HUD is great when in IMC. In VMC being able to easily declutter and adjust intensity of HUD data is essential. Photocell and adjust intensity automatically with manual backup. Declutter for terrain & data needs to be easy for pilot flying to do himself. Confused communications about display between crew could be dangerous.

SUBJECT 13: Opaqueness of the HUD is good. The terrain is a good addition but I saw little benefit with any terrain display other than a generic presentation. I did have some confusion with the display during turns caused by the tunnel corner “ties” interfering with the guidance cues and “pitch ladder”.

SUBJECT 14: I think the configuration should allow quick/easy look around or turn-off if being used during approach phases.

6. Please discuss the use of the tunnel to perform the missed approach to rwy 7. What features of the tunnel did you particularly find most helpful in maintaining situation awareness?

SUBJECT 1: I see no advantage to the tunnel. Especially in Size A it was more a distraction than help.

SUBJECT 2: Nice piece of additional cues to give pilot indication of proper path.

SUBJECT 3: (no comments)

SUBJECT 4: The tunnel was an enhancement because it provided a few second "look ahead" of what change in course was about to happen. It allowed pilot to anticipate any turns coming up.

SUBJECT 5: Gave you a forecast of where you wanted to make A/C go.

SUBJECT 6: The tunnel concept was great! But only used it on the approach and circle not the missed appr. The MAP seems easier with only a flight director though.

SUBJECT 7: The tunnel is a nice big picture but I would prefer it to be more dynamic (i.e. lines get longer as you pass by them.)

SUBJECT 8: Better SA for flight path (descents, climbs, turns) 5-10+ seconds down the road.

SUBJECT 9: I didn't really see much tunnel on missed approach. It was very beneficial during the approach to rwy 7.

SUBJECT 10: Ineffective. Once the tunnel was allowed to pass out of view there was no flight guidance. It would be very helpful to have traditional cues on the edges of the PFD.

SUBJECT 11: On the missed approach I did not really use the tunnel. I followed "flight director" and cross checked other instruments.

SUBJECT 12: Didn't really see the tunnel on missed approach it was most helpful as a turn cue to anticipate movement of ghost airplane.

SUBJECT 13: The tunnel provides good course guidance when in the tunnel. Outside the tunnel during a turn it is initially difficult to (illegible) the lateral and vertical deviations and the correct direction to return to the tunnel. Staying in the tunnel with guidance proved all the necessary SA needed to complete the approach.

SUBJECT 14: Flying in the tunnel gave comfort in providing a "zone" showing reasonable boundaries. This way one doesn't have to over-concentrate on flying some exact line through the sky. Also was useful in predicting flight path & providing a sense of timing during flight.

7. Was there any symbology on the NASA HUD or HDD display concepts that you found confusing or difficult to use? Any symbology cues that you found helpful?

Symbology that was confusing:

SUBJECT 1: The envelope arrows could be confusing. Especially on Size A. Too close to other useful info with the same color. Too hard to differentiate.

SUBJECT 2: None.

SUBJECT 3: On Size A – decluttering would be appreciated

SUBJECT 4: During the missed approach, the flight director changed from ghost airplane to just a ball. This transition was mildly confusing.

SUBJECT 5: The flight director airplane. Felt it was too big and instead of following it, I wanted to fly form on it.

SUBJECT 6: The FD wasn't helpful on missed appr in circle only mode.

SUBJECT 7: Water line cue is not needed and did confuse me on one run.

SUBJECT 8: Heading cue needs to be larger. Noodle (or turn trend) seems overly sensitive.

SUBJECT 9: need a velocity vector on missed approach that is easier to see/follow.

SUBJECT 10: tunnel – difficult

SUBJECT 11: Size A HDD unity FOV difficult to see symbology; Baseline with 60 degree FOV symbology does not do well. In general trying to fly 'ball in ball' will cause PIO's

SUBJECT 12: Dual cue flight director. A single cue FD is much easier to interpret and does the same job. No need to make things any harder.

SUBJECT 13: Heading numbers compressed. Sometimes difficult to read ghost a/c over correcting in turns increased workload some. Vertical speed display needs to be moved out of altitude tape on the SVS PFD displays. Tunnel corners conflict wit pitch ladder during turns on HUD display. Radar altitude display over altitude tape on some displays difficult to see.

SUBJECT 14: Lack of pitch reference at the longitudinal axis on the HUD (attributed to a software problem).

Symbology that was helpful:

SUBJECT 1: The magenta path triangle was a useful trend info, especially in Size X.

SUBJECT 2: Ghost airplane was a great tool.

SUBJECT 3: Great gates on HDD – thought this allowed for rapid recognition of special orientation.

SUBJECT 4: Ghost airplane was helpful because during turns it provided two-dimensional info.

SUBJECT 5: Tunnel, speed symbol.

SUBJECT 6: The phantom airplane and tunnel concept were great.

SUBJECT 7: Flight Path Vector (FPV) – Worm – energy carat great. Radar altitude center box should pop up at 1000' – also radar altitude thermometer scales are excellent (drawn radar alt thermometer drawn).

Scale goes down closer you get to ground. This scale would pop up on right of display when below 1000' replacing or next to altitude scale.

SUBJECT 8: Tunnel, ghost A/C, VSD

SUBJECT 9: ghost ACFT & tunnel; terrain (generic, photo & HUD)

SUBJECT 10: “flying triangle” flight director

SUBJECT 11: Tunnel on HDD for approach, turning symbology on follow me a/c, yellow terrain bar that comes into view when w/in 200 ft AGL.

SUBJECT 12: All of the symbology was helpful but it was almost too much info to scan interpret and then use at one time. Relevant info needs to appear and disappear automatically based on phase of flight (i.e. no need for radar alt at cruise above 1500')

SUBJECT 13: Ghost aircraft and velocity vector. Speed trend bar and speed cue attached to guidance circle.

SUBJECT 14: “Tunnel”, follow-me aircraft symbol, god’s eye view of programmed ground track.

8. Please provide any comments regarding whether field-of-view (FOV) requirements may change as a function of phase of flight (Example: "I would like to use 90 FOV for cruise but prefer unity FOV for approach:).

SUBJECT 1: 60 degrees was preferred until close in (within 3 nmi and 1000' above), then 30 degrees seemed to be a better depiction – more to scale so to speak.

SUBJECT 2: I found 30 ideal for most phases. 60-90 worded OK in hard turns so you could see where you're going. Unity seemed overly restrictive (who would fly a real airplane if the entire front windscreen was only 8"x8" window?)

SUBJECT 3: I would like to use 90-60 at altitude. On climb and descent scan thru 30. Unity would be good in a short to in close. Unity is least used.

SUBJECT 4: Each pilot has a different preference depending on situation. I preferred 30 FOV for approach and 60 FOV for missed approach.

SUBJECT 5: It was easier to fly in larger field of view. Unity was too sensitive and in landing config picture dropped off the bottom.

SUBJECT 6: Me personally, I liked 30 degree best for all phases of flight, but I guess it was cool being able to change this if I wanted to.

SUBJECT 7: The FOV problem was actually an elevation problem. You had to change FOV to see more below the FPV. It would be best I think to have a set FOV and lower the viewable area below the FPV.

SUBJECT 8: Did not like unity for any phase of flight. Felt 60 degree FOV provided best all phase of flight integration, however symbology can become cluttered at times with a resultant situation where ghost aircraft target dot becomes hidden. 30 degree FOV symbology/clutter seems most usable, however correction sensitivities seem magnified leading to PIO or mild over controlling of flt. Ctls. Preferred 90 degree FOV for 'low clearance' ridge crossing because of detail however, corrections and sensitivities are dampened when they may be needed most.

SUBJECT 9: 60 degree FOV for cruise though not as precise, 30 degree FOV for final, unity was not useful to me

SUBJECT 10: It was possible to select a FOV that was too narrow to encompass the missed approach procedure & course guidance.

SUBJECT 11: Yes, the requirement will change, unity would be nice to use all the time ... like the real world. The further above ground & away from the airport the wider the FOV I would use.

SUBJECT 12: For Size A display the 30 degree FOV seemed better for approach but the 60 degree FOV gave better pitch reference ladder bars for missed approach. Pilot flying shouldn't be thinking about changing FOV at missed approach point. Change should be automatic.

SUBJECT 13: FOV was changed from 30 to 60 during the go around. The rest of the time I used the 30. The change was made to be able to see the guidance better.

SUBJECT 14: I found myself using the 30 degree FOV for pre-approach maneuvering. 60 degrees during turning descent, 30 during initial climbout. As high terrain approached 60 & then 90 revealed close high terrain.

9. Would you prefer that the FOV settings be pilot-selectable or engineered into the system (i.e., FOV changes remain static based on phase of flight)?

SUBJECT 1: Pilot selectable.

SUBJECT 2: Pilot selectable!

SUBJECT 3: (no comment)

SUBJECT 4: Pilot-selectable! Everyone has a different preference however the only exception would be during a missed approach. I found it mildly difficult to change FOV while executing a missed approach – This is a crew coordination item where the pilot not flying changes FOV when commanded by the pilot flying.

SUBJECT 5: Pilot select.

SUBJECT 6: Absolutely pilot selectable! Everyone has a different

SUBJECT 7: Pilot selectable

SUBJECT 8: FOV changes should NOT remain static but would like to see a less cumbersome way to control FOV & range, eg. Making it a 'HOTAS' (F-18 option) system where changes can be made via a pushbutton on either the stick or throttle (actually mouse operation can also be conducted this way via an index finger mouse/push button on stick or throttle).

SUBJECT 9: Pilot selectable since different approaches & terrain may require a system no "hard wired"

SUBJECT 10: Both. Selectable for all operations with an "auto" feature for the most advantageous FOV to "pop up" during emergency and abnormal OPS including missed approach procedures.

SUBJECT 11: Pilot selectable but should allow pilot to set automatic changes such as going 60 degree FOV on missed approach.

SUBJECT 12: Engineer changes that would switch for optimum clarity automatically for the phase of flight with pilot override for failures or emergencies.

SUBJECT 13: Both. Default changes based on phase of flight (and studies determining the best FOV per flight phase) but allow pilot selectable option due to pilot preference or requirements.

SUBJECT 14: Pilot selectable! I found the trackball hard to use and would have preferred a rotary switch for the FOV selections – This also could be a crew coordination item (task non flying pilot to make the changes).

10. If you had to select between two different FOVs that may be pilot selectable, which two FOVs would be chosen and why?

SUBJECT 1: 60 degrees and 30 degrees. The only 2 that seemed comfortable. Those 2 seemed to more represent actual conditions.

SUBJECT 2: Depends on situation – I would choose 30 & 60. 30 for most situations; 60 – during turns, increases SA, during missed approach, too.

SUBJECT 3: 90-30; 90 at altitude and 30 on T/O and arrival.

SUBJECT 4: Unity and 60 degree keeps a “normal” picture while 60 degrees provides adequate FOV for a missed approach.

SUBJECT 5: 30 & 90; 90 was good for approach phase; 30 was needed for landing phase.

SUBJECT 6: 30 degrees was my preference. Easier for me to use and view.

SUBJECT 7: Unity and 45 degrees.

SUBJECT 8: 30/60 – explained in answer #8

SUBJECT 9: 30 & 60. See #8

SUBJECT 10: 30 degree approach – easiest scale to use. 90 degree arrival & missed approach – offers a wide FOV for terrain info.

SUBJECT 11: For Size X – unity and 60 degree for Size A – 30 degree and 60 degree. I think 90 degree is not required and unity is difficult to use on Size A.

SUBJECT 12: 30 degrees or 60 degrees. 30 seemed detailed enough for approach. 60 was good for missed approach. 90 is a little too wide for good detail resolution of man made objects and airports.

SUBJECT 13: During runs only FOVs I used were 30 and 60. Tied all the views but these were the only 2 used.

SUBJECT 14: If I could only have 2 FOV's to use, I'd choose 30 and 60. Unity seemed too much like looking through a straw. 90 could be left out as 60 provided expanded view; at 90, you're essentially past the problem – terrain.

11. Given a choice about where to display the image, what would you recommend for:

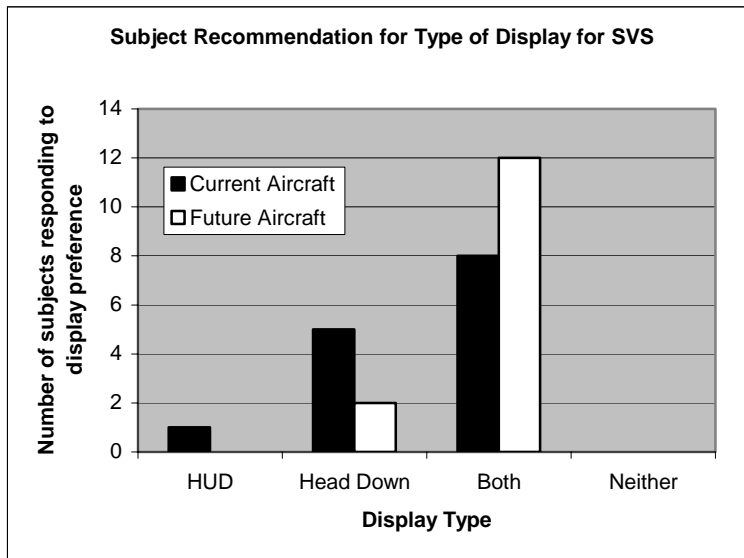

Please comment on your choice:

SUBJECT 1: Choices without cost factors. With cost factors I would choose Size X Photo slightly above HUD.

SUBJECT 2: Of course, more is better. A HUD would help for the critical transition to outside visual references, but it is somewhat harder to fly during heavy maneuvering due to its limited FOV.

SUBJECT 3: HUD is great for safety as to other aircraft. Just feel both allow for both pilot flying and non-flying pilot situational awareness. One peek is worth a thousand scans.

SUBJECT 4: Cost aside, I am big proponent for HUDs on commercial aircraft – keep eyes outside aircraft as much as possible.

SUBJECT 5: Seems the refit for a HUD on 757 would be cost prohibitive if money were no issue then both would be great.

SUBJECT 6: As long as its pilot selectable why not offer this info to both locations and let the pilot decide where he/she wants to view it.

SUBJECT 7: Head up is far superior because it gives you one for one with the outside world and reduces transition to outside world when landing. Head down is good backup. And helps those not HUD pilot transition easier.

SUBJECT 8: (no comment)

SUBJECT 9: Unless HUD is available to both pilots, crew coordination would necessitate both systems as backup. Also consider target audience and their experience with or w/o a HUD. Chances are initially most will feel comfortable w/ some sort of head-down system needed as a backup.

SUBJECT 10: Most useful for the pilot to have the same information available when going from heads down to heads up during the final landing phase as well as all other operations near and around terrain.

SUBJECT 11: The display is for flying in IFR, so it is natural to be inside (HDD) putting info on HUD could cause problems and is not as good (two colors) as the HDD.

SUBJECT 12: Unless the HUD is installed at both pilot stations the Head Down display makes more sense. Head down is part of the already existent instrument scan, would probably require less training time and achieve the same goal.

SUBJECT 13: Use of both head up/down would allow non flying pilot the ability to better monitor the aircraft path when the flying pilot is using a head up display.

SUBJECT 14: For Airbus – PFD (ie size X) would be enough – easy to see the detail. For 757 I'd make a HUD optional – for future acft the same. I frankly think that the low frequency of flights into poor vis and challenging terrain might not justify expense of a HUD just for this; however if the aircraft is going to have a HUD, this is a great option.

12. Please rate your estimate of the lowest acceptability of the following display sizes and image resolution based on using the display to fly the airplane.

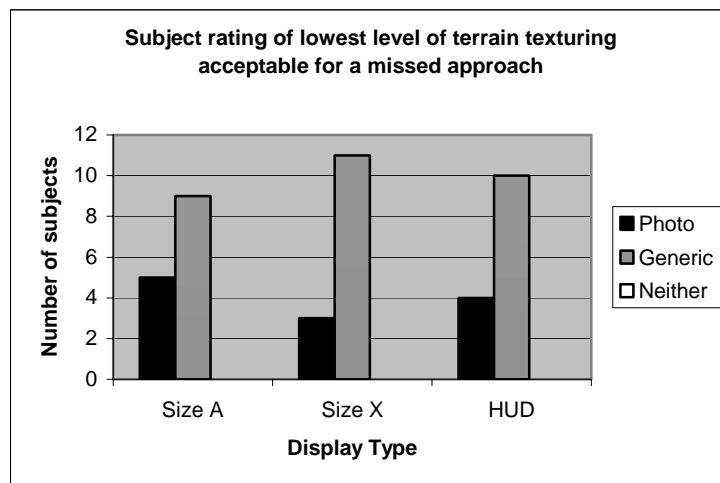
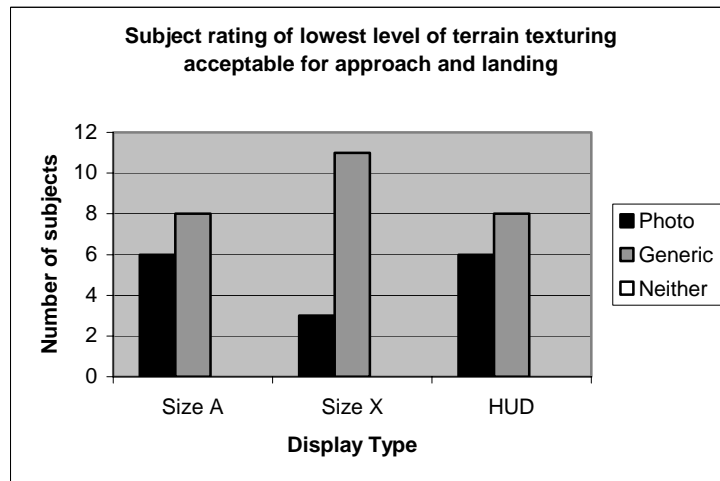
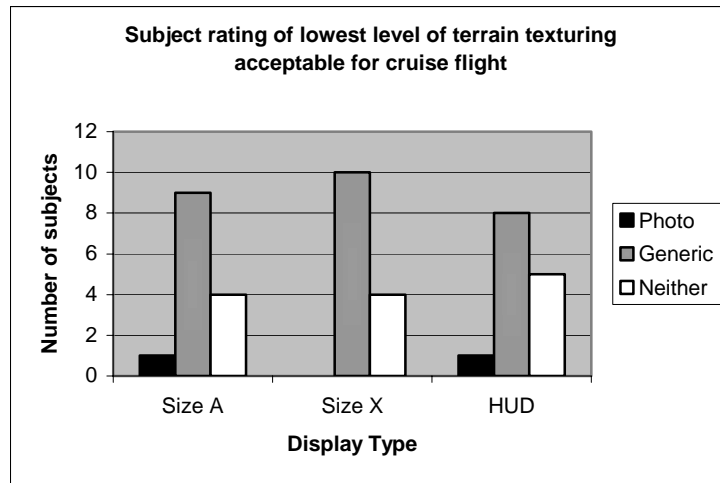

13. In the figure, please draw or indicate the changes you would want to incorporate into a head-up SVS display or any changes that you think would enhance the performance and safety benefits of the SVS HUD. You may draw directly on the figure or use the box below.



- SUBJECT 1: I would like to see a wind arrow or wind direction & speed in the top right (or left) of the screen.
- SUBJECT 2: No complaints. Nice depiction. Works for me.
- SUBJECT 3: (slip indicator under roll pointer and the airplane symbol in the compass rose are marked as redundant).
- SUBJECT 4: (a commanded roll carot is drawn on roll scale) – add another “carot” that provides roll info during turns. Have radio altitude flash if it gets below a certain value. E.g. 500 feet (with gear not down). This will draw attention to how low he really is.
- SUBJECT 5: Eliminate (compass with airplane symbol circled). Shrink A/S and Alt scales. Eliminate hdg at top H 255.
- SUBJECT 6: Only suggestion is to allow the ability to declutter some info if the pilot deems it worthy.
- SUBJECT 7: Add synthetic features like runways, towers, mtn tops, i.e. significant obstacles. Change FPV to have vertical tail. Add bank angle cues (small roll scale drawn above velocity vector). Add pop up thermometer radar altitude scale described earlier. Remove waterline. Add color. Add command steering cue (ghost airplane with tail hitch drawn).
- SUBJECT 8: HDG declutter – if selected on: - H255 at top of display becomes larger. MSA readouts. Contrast knob to ctl tunnel brightness. If VSD not part of package, have high points depicted with a carot or icon.
- SUBJECT 9: Delete GS and radio alt. Add wind vector and distance to waypoint X
- SUBJECT 10: “anticipated path” flight director w/ 3 flying triangles in addition or instead of “tunnel”. (drawn is a noodle type presentation on the PFD with 3 ghost type airplanes). Move RA out of center FOV (the 1470 shown in picture to lower right). Display traditional course guidance LOC & GS (drawn are LOC and GS scales on left and bottom of display)
- SUBJECT 11: (circle drawn around compass rose) clutter, could be removed, there are 3 ways to see heading in this HUD.
- SUBJECT 12: (noted on airspeed and altitude scales is poor contrasting). This was not the display used in the test. Move the heading display down to the compass depiction either inside the circle or on top of the

carat. What's the 1470 for? If its radio alt then why is Radio 100 on the lower right? Move the airspeed and alt tapes to the outer edge so each would have a black background. This would make more of the photo terrain visible and enhance visibility of the light green numbers. Contrast between light green number and light green terrain is poor.

SUBJECT 13: (circle drawn around altitude scale readout) numbers hard to read. (illegible) the altitude tape. Occasionally I found the display confusing. Some numbers disappear in the terrain. Tunnel corners also got confusing when a/c was pitched up. Corners clashed with pitch ladder.

SUBJECT 14: I'd take out the lower compass rose – that's where I'd be checking for high terrain. The rest of the items are not distracting. I'd take the pitch numbers off on side of the ADI presentation.

14. In the figure, please draw or indicate the changes you would want to incorporate into a head-down SVS display or any changes that you think would enhance the performance and safety benefits of the SVS PFD. You may draw directly on the figure or use the box below.



- SUBJECT 1: Specifically, Size A, change tunnel color to a muted color. This will eliminate magenta clutter on screen. I would like to see a wind arrow in the top left corner of the screen.
- SUBJECT 2: VNAV and LNAV status at top of display.
- SUBJECT 3: Dim the heading components would help (clutter).
- SUBJECT 4: Same as HUD drawing. The flight director does not provide roll info. SO pilot has to guess as to how much bank to use. This leads to chasing flight director. Also SVS is a great enhancement but it does not provide the “ground rush” effect if an airplane is approaching terrain rapidly. This is because SVS provides limited FOV as compared to real flying. Add something to display that will alert pilot of terrain proximity e.g. flashing radio altitude.
- SUBJECT 5: Shrink A/S and Alt scales.
- SUBJECT 6: All these concepts above are awesome. Wouldn't change anything.
- SUBJECT 7: Same as question 13. Both should be the same.
- SUBJECT 8: No changes.
- SUBJECT 9: Distance to waypoint or destination
- SUBJECT 10: Add flap bug speeds to tape (ie, F2, F15, F30). Change crow's feet to boxes and make # of boxes a selectable feature.
- SUBJECT 11: looks good.
- SUBJECT 12: Move the tapes off the photo background and give them a black background. This would also declutter the photo and make more of it visible. Change the aircraft symbology to a single cue flight director.
- SUBJECT 13: (drew circle around velocity vector/ghost aircraft cluster) Too much clutter with velocity vector, ghost a/c, heading reference, etc. (drew circle around altitude scale) Vertical speed very hard to reference. Gets lost in altitude tape. (drew circle around decision height box) Hard to see in FOV.
- SUBJECT 14: I'd make the tunnel symbology a bit larger; eliminate the vertical lines (magenta) down to the ground track X's. I'd like the scales on the size X to be smaller.

15. Overall, please rank order what you believe the SVS display concepts would best support:

Enhanced Intuitive View and Enhanced Situation Awareness

Provides day Visual Meteorological Conditions in Instrument Meteorological Conditions

Hazard / Obstacle Detection & Display

Displays terrain and obstacles that present hazards to the aircraft as well as provide warning and avoidance alerting

Precision Navigation Guidance

SVS virtual displays like taxi maps, tunnel / pathway guidance and navigation cues to accurately view own-ship location, terrain, etc. and help in achieving RNP/RNAV approach minimums, curved approaches, noise abatement, etc.

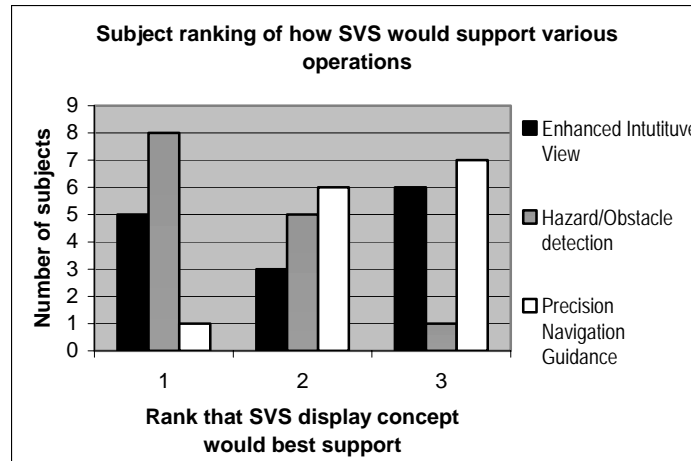

Please comment on your choice

SUBJECT 1: 1 leads to 2. A picture is worth a thousand yellow and red dots.

SUBJECT 2: Curved approaches would most improve capability of current system. Obstacle detection not as important most places we routinely fly.

SUBJECT 3: CFIT is the concern of most flying in some domestic airports and many countries out con US.

SUBJECT 4: 1- Missing mountains and obstacles are critical. 2- Precision guidance is a nice-to-have capability but not critical. 3- VMC can never really be duplicated with SVS due to limited FOV

SUBJECT 5: In IMC conditions getting a peek at the ground is great for SA so a continuous projection of the ground or terrain would be awesome!

SUBJECT 6: (no comment)

SUBJECT 7: All very important. Hard to rank.

SUBJECT 8: Invaluable for #2, however would be used more routinely in day to day operations for #1 and #3.

SUBJECT 9: (no comment)

SUBJECT 10: (no comment)

SUBJECT 11: SVS display concepts would support all so I ranked for where I think the greatest need is.

Already good displays to show hazards. Need to have SA on the hazard.

SUBJECT 12: Seems like the whole point is to enhance terrain & obstacle awareness whether its on the PFD or the HUD. The other benefits are good too but solving the CFIT problem has to come first.

SUBJECT 13: CFIT is still the biggest safety problem we have. Displaying the terrain and obstacles to the pilot has to help the CFIT with the enhanced intuitive view a close second. We are doing precision nav now so it can wait a little longer for implementation in an SVS form.

SUBJECT 14: Managed navigation and automated approaches generally cover normal operations. The enhanced situational awareness gives options if flight choices are required. Would provide high confidence option if manual/emergency intervention is required.

16. Please provide your ranks of what phase of flight SVS would best support:

- _____ Ground Operations
- _____ Departure Operations
- _____ En Route Operations
- _____ Arrival and Approach Operations

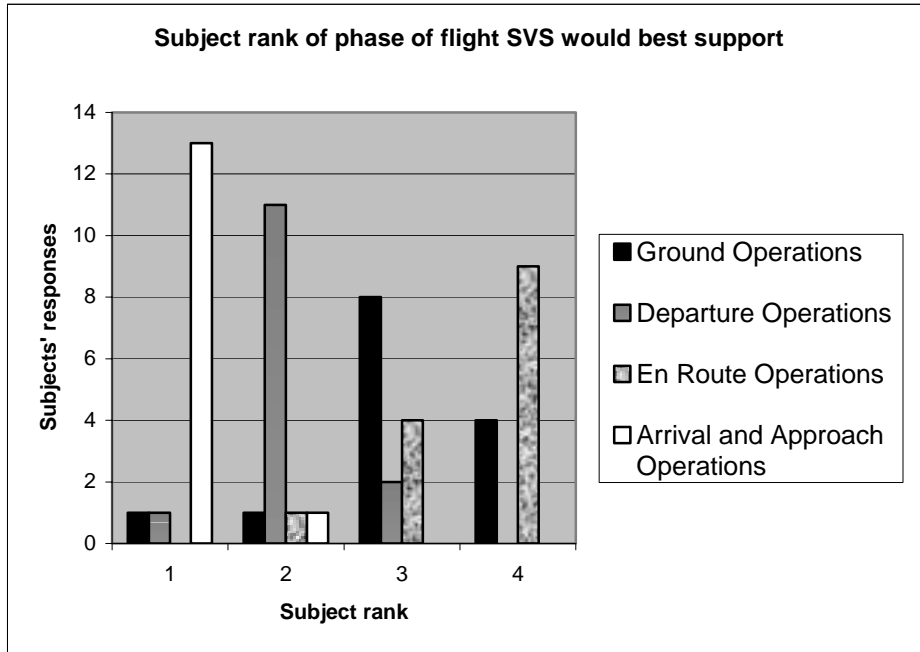

17. Please discuss how SVS display concepts could be used to support each of these flight operations.

SUBJECT 1: Ground OPS SVS might improve in ranking if proven to be accurate enough with enough resolution to show taxiway signs & markings, especially runway entry points, with traffic signal lights based on approaching traffic (ground or airbourne).

SUBJECT 2: Arrival 1 – curved approaches would increase system capacity & help with noise abatement.

Ground 2 – would help considerably in low viz conditions. Reduce rwy incursions. Dept 3 – not as necessary due to high climb rates on most acft. Enroute 4 – waste of money.

SUBJECT 3: If I know where I am, I know how to get to other points. The greatest concern for me is accurate knowledge of present position. In Wx/night/beyond visual range situations.

SUBJECT 4: 1) Arrival and departure procedures – pilots would have a complete understanding of written procedures. 2) Enroute – SA would be improved with better knowledge of aircraft position. 3) Ground – SVS could improve taxiing around in fog. Help avoid runway incursions.

SUBJECT 5: The experiment type display was a good base line for arrival & approach.

SUBJECT 6: With a high resolution, the limits are endless!

SUBJECT 7: Arrival & approach is the highest safety threat time having better ground SA will save lives. En route is our most benign for airlines so it is of least value. Ground OPS, especially with marginal Wx is the second best pay off area.

SUBJECT 8: 1&2(Arrival and departure ops) – SID, STAR, approach enhancement with tunnel pathway, CFIT avoidance, missed approach guidance. 4 (en route ops) – if TCAS alerts could be programmed into display somehow?- engine out – drift down info critical terrain areas. 3 (ground ops) – SMGCS operations – low vis taxiing. Enhanced SA in all flight envelopes

SUBJECT 9: (no comment)

SUBJECT 10: SVS would be very helpful in every area except ground ops. Vehicles and other aircraft are the obstacle not terrain.

SUBJECT 11: For ground ops could allow to taxi in very bad weather. I believe taxiing in bad weather is currently a limiting factor in A/C departures. In all others provide SA. Closer to the ground the more SA is required.

SUBJECT 12: Arrival approach and departure phase use could reduce CFIT. Ground ops use could reduce runway incursions. Enroute use would only help avoid mid air collisions if resolutions is good enough to show other aircraft in enough time to allow avoidance maneuvers. Unfortunately, the best, most thoroughly detailed display is worthless unless pilots are well trained and take the information seriously. Far too many “professional” aviators blow off TAWS and GPWS data because they try to out think or rationalize what the system is doing. Until pilot attitudes are changed the best tools in the world won’t stop CFIT or mid air collisions.

SUBJECT 13: Ground ops – low vis taxi, surface collision avoidance if ground equipment can be included in the display. Ground position awareness. Dep ops – better guidance for complex departures, terrain avoidance, aircraft avoidance when in high nose up attitudes. Enroute – traffic awareness. Arrival/Approach – closely spaced approaches – improve position awareness, remove the IMC to VMC transition during low IMC conditions. Terrain awareness

SUBJECT 14: Approach – reduced separation during low vis approach ops. Departures – selectable departure profiles would greatly aid lookout in congested areas. Enroute – display TCAS items. Gnd Ops – low visibility taxi ops, runway incursion – prevention, ground guidance & sequencing.

18. Please provide your comments on operational benefits of SVS for the following operations:

Independent operations on closely spaced, parallel runways (e.g., station keeping)

SUBJECT 1: Would have to be combined with some sort of ACFT to ACFT separation monitoring & warning system with TCAS like (TA/RA). Huge system reliability requirements.

SUBJECT 2: Allows for curved approaches

SUBJECT 3: 90 would be helpful in the prm regime.

SUBJECT 4: Potential benefit depending on pilot workload to process info.

SUBJECT 5: Good for overall SA but if you can't see the other aircraft you still won't have a complete warm & fuzzy compared with VFR conditions.

SUBJECT 6: helpful

SUBJECT 7: Very important – SVS could significantly improve airport capacity and safety, especially if artificial view of wing tip vortices could be displayed based on current wind conditions.

SUBJECT 8: Low altitude holding in critical terrain areas.

SUBJECT 9: Very good for SA

SUBJECT 10: NIL

SUBJE 11: would provide benefits if could be certified.

SUBJECT 12: useful only if you can display the other aircraft also on the approach.

SUBJECT 13: could help during PRM to improve position awareness which might limit the descending breakout manv. if wake detections capabilities are developed perhaps they could be displayed to allow closer spacing to increase capacity.

SUBJECT 14: Tunnels would enhance ability to maintain strict flight path/approach paths.

Reduced inter-arrival separation and self-spacing capabilities

SUBJECT 1: Warning, only with much greater sensitivity. Huge system reliability requirements.

SUBJECT 2: Don't necessarily see how it could help here.

SUBJECT 3: Opening or closing distances would be self regulated with the better SA.

SUBJECT 4: Potential benefit depending on pilot workload to process info.

SUBJECT 5: Not a lot of benefit.

SUBJECT 6: OK

SUBJECT 7: Same as above.

SUBJECT 8: ?

SUBJECT 9: Only if tightly coupled w/ TCAS in low vis operations

SUBJECT 10: NIL

SUBJECT 11: good potential to allow for closer spacing in bad weather.

SUBJECT 12: ATC has a hard enough time with the arrival separation as close as it is now.

SUBJECT 13: Same as above. TCAS on the display could help with acquiring a target a/c quicker perhaps improving acceptance rates.

SUBJECT 14: Especially in marginal VFR conditions precise flight path guidance – tunnels – could enable closer spacing.

Converging and circling approaches and departures

SUBJECT 1: Huge system reliability requirements.

SUBJECT 2: Obviously, SVS makes complex arrivals/departures easier.

SUBJECT 3: As proven in the experiment.

SUBJECT 4: Potential benefit depending on ease in setting up approach/departure in FMC.

SUBJECT 5: Great SA builder to keep an idea of where the terrain is.

SUBJECT 6: Absolutely an asset! Low & slow flight, this adds a tremendous safety margin.

SUBJECT 7: Same as above.

SUBJECT 8: ?

SUBJECT 9: excellent but should have TCAS inputs available

SUBJECT 10: circling approaches – yes – offers additional useful info for terrain avoidance and situational awareness.

SUBJECT 11: good SA builder

SUBJECT 12: ('circling approaches' has been circled) in routine airline operations? This will only increase the accident rate.

SUBJECT 13: Improved CFIT – any circling manv. are improved with terrain awareness. Also helps with positional awareness when at an MUA altitude.
SUBJECT 14: Again aids to precision

Reduced arrival and departure minimums

SUBJECT 1: Would require photo realistic HUD. This would allow lower minimums for hand flown approaches. Not sure what benefit to newer commercial ACFT with CAT III capability, unless it can be proven capable of 0/0 landings ie transition to landing on SVS.
SUBJECT 2: Absolutely!
SUBJECT 3: Flying either would be aided thru path direction and potential for wake turbulence events. If all acft fly the same path, the crosswind would be less likely to allow wake events.
SUBJECT 4: Great benefit to land or takeoff in lower weather conditions.
SUBJECT 5: Yes being able to “see” the runway environment will help a lot with arrivals.
SUBJECT 6: ?
SUBJECT 7: Same as above.
SUBJECT 8: (no comment)
SUBJECT 9: Limited use
SUBJECT 10: NIL
SUBJECT 11: not really in the commercial sector. Can go pretty low now & I think it’s to the point where Wx to taxi is limiting factor.
SUBJECT 12: see comment for reduced inter-arrival separation
SUBJECT 13: SVS should allow lower mins where ground based aids such as runway lights or approach lights are presently required. Departure mins that are based on visibility or terrain awareness could possibly be lowered.
SUBJECT 14: Should allow many more contact approach procedures.

Reduced runway occupancy time

SUBJECT 1: And ACFT display. With resolution to allow accurate identification of specific intersections.
SUBJECT 2: In heavy fog, absolutely. Would allow day VFR landing rates in IMC conditions.
SUBJECT 3: Flying either would be aided thru path direction and potential for wake turbulence events. If all acft fly the same path, the crosswind would be less likely to allow wake events.
SUBJECT 4: Great benefit for pilots to identify correct taxiway when leaving runway.
SUBJECT 5: Not much benefit.
SUBJECT 6: ?
SUBJECT 7: Same as above.
SUBJECT 8: ?
SUBJECT 9: Limited. Timing seems best approach.
SUBJECT 10: NIL
SUBJECT 11: Not too much with the concepts shown.
SUBJECT 12: see comment for reduced inter-arrival separation
SUBJECT 13: In low vis will be able to see approaching turnoffs quicker, keeping pressure on the runway. Low vis – help with runway incursion prevention.
SUBJECT 14: (no comment)

Taxi operations

SUBJECT 1: With resolution to allow accurate identification of specific intersections.

SUBJECT 2: Sure.

SUBJECT 3: This is an option that would cause some growing pains. Signage and data linked taxi instructions would remain as the primary.

SUBJECT 4: Great benefit in fog.

SUBJECT 5: Not much.

SUBJECT 6: helpful, but unless everyone has it ...then??

SUBJECT 7: Big threat are reason controllers are up in towers is to get a better view of big picture, SVS brings big picture into the cockpit.

SUBJECT 8: SIMGCS – low vis – answers the “Where are we?” question

SUBJECT 9: very good for pre-planned taxi routes and SMGS operations

SUBJECT 10: NIL

SUBJECT 11: Excellent potential & operational benefits.

SUBJECT 12: see comment for reduced inter-arrival separation

SUBJECT 13: Lower taxi mins could allow cat 3c (zero zero) if the ability to get to the gate was available through SVS. Runway incursion prevention could improve when vis is low. A/c position awareness would improve.

SUBJECT 14: (no comment)

En-route operations

SUBJECT 1: Limited benefit.

SUBJECT 2: No.

SUBJECT 3: SA, SA, SA – especially for Wx deviation when incorporating Wx on the HUD. Or any SVS.

SUBJECT 4: Good benefit.

SUBJECT 5: Good for drift down scenarios.

SUBJECT 6: OK

SUBJECT 7: Will provide better view than TCAS will be essential when we go to free flight.

SUBJECT 8: Critical terrain drift down – engine out

SUBJECT 9: Limited above 25K'. TCAS inputs on HUD would help resolve traffic conflicts.

SUBJECT 10: terrain avoidance & enhanced situational awareness.

SUBJECT 11: Limited.

SUBJECT 12: (no comment)

SUBJECT 13: SVS would have to have radar display and TCAS displays to improve enroute ops.

SUBJECT 14: enhanced situational awareness, depending on the amount of data points available.

Aircraft energy management

SUBJECT 1: Limited benefit.

SUBJECT 2: Not that I see, but I guess in a IMC low energy state (stall/windshear) having a ground reference could help.

SUBJECT 3: Fuel savings would be tremendous. Proper spacing and reduced vectoring by ATC would enhance both SA and fuel expenditure.

SUBJECT 4: Good feature.

SUBJECT 5: Overall SA enhancement.

SUBJECT 6: Good idea.

SUBJECT 7: Big pay off here if implemented right.

SUBJECT 8: (no comment)

SUBJECT 9: Limited use w/o AOA info & Ps diagram.

SUBJECT 10: helpful during low level ops

SUBJECT 11: Limited.

SUBJECT 12: Airline management will negate any possible benefit because of their inability to plan appropriate profiles.

SUBJECT 13: Projection of a path (tunnel) that is base on a/c energy state might improve fuel economies.

Fix ETAs for A/C management and CFIT reduction if projected path to the ground is displayed.

SUBJECT 14: (no comment)

Other

ONE SUBJECT RESPONDED: The aids to SA could be very important in unplanned go-around situations.

19. Please comment on the use of SVS display concepts for supporting non-normal operations and discuss how SVS may benefit these operations. Based on your experience during the experimental study, please discuss the use of SVS display concepts for non-normal situations:

Some Examples:

Upset recognition and recovery
En-route diversion planning
Traffic and weather hazard deconfliction during engine out drift down
Improved emergency descent awareness of terrain, traffic, etc.
Depiction of missed approach guidance
Intuitive emergency procedure support and guidance
Others

SUBJECT 1: HUD & SVS would almost eliminate possibility of tunnel vision (decreased scan) due to abnormal operation or emergency.

SUBJECT 2: Greatly reduces pilot workload during IMC arrivals. If pilot not flying is working emergency, allows for safer operation by increasing pilot SA. Great aid for upset recovery.

SUBJECT 3: The possibility to flying approach (practice) at altitude prior to descending into either mountainous terrain of foul weather could easily prevent CFIT events.

SUBJECT 4: SVS provides valuable info such that if a pilot loses an engine, the pilot can determine which way to turn the airplane to avoid hitting terrain. VSD is a good tool with regard to this.

SUBJECT 5: Engine out terrain avoidance both on T/O and missed approach would be awesome. Also drift down terrain avoidance would help also.

SUBJECT 6: Help to reduce pilot workload during high stress situations.

SUBJECT 7: Only non-normal we did was eng out but this is a big, big benefit in all examples mentioned below.

SUBJECT 8: Enroute diversion to little used divert fields – unfamiliarity with terrain – drift down in critical terrain with escape routes – Alaska, Europe, S America, Rockies, etc.

SUBJECT 9: Adverse weather (thunderstorms/windshear) would be a big help. Upset recovery also a great benefit. Have you considered drift down representation?

SUBJECT 10: Extremely useful for terrain avoidance for emergency descents and engine failure situations during low level and/or high terrain operations

SUBJECT 11: While is no necessary to determine a non-normal situation is occurring, it was essential in providing guidance in what to do during a non-normal situation.

SUBJECT 12: (no comment)

SUBJECT 13: Altitude awareness during non-normals might be one of the biggest advantages of SVS followed by terrain awareness. Both of these are concerns during engine failure non normals.

SUBJECT 14: Coupled to TCAS – could be important to near-miss/midair avoidance especially in arrival/departure situations. Terrain proximity awareness could be the cure for many distraction-related potentials.

20. Please comment on your confidence in using these SVS display concepts to make CAT IIIc approach, departure, and taxi operations

1	2	3	4	5	6	7	8	9
---	---	---	---	---	---	---	---	---

Not Confident (0%)

Very Confident (100%)

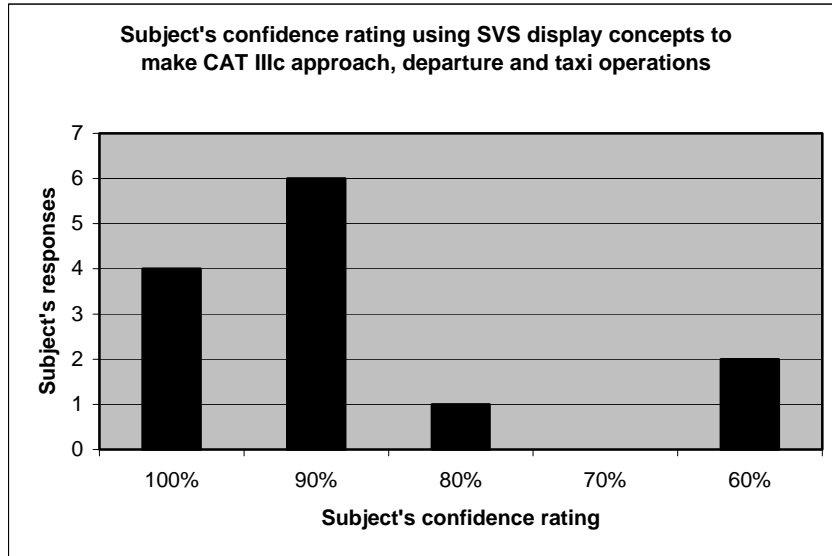

SUBJECT 1: 9 In APP & DEP

SUBJECT 2: You don't hit the ground when you can see it.

SUBJECT 3: Actual NAV performance displayed versus required NAV performance would this a 9+.

SUBJECT 4: All of the visual cues are present with SVS to perform these tasks.

SUBJECT 5: (no comment)

SUBJECT 6: (no comment)

SUBJECT 7: (no comment)

SUBJECT 8: (no comment)

SUBJECT 9: (no comment)

SUBJECT 10: not useful for taxi operations because it offers no information on/about obstructions vehicles or other aircraft that maybe unseen.

SUBJECT 11: Should be very good as long as it is reliable.

SUBJECT 12: Never done CAT IIIc

SUBJECT 13: Biggest concern has more to do with data integrity and accuracy then SVS capability.

SUBJECT 14: I think superimposing the guidance on heads-down systems would greatly improve planning and situation awareness during the approach.

If not 100% confident, please comment on what could be added (e.g., sensors) to increase your level of confidence

SUBJECT 1: No exposure to landing and taxi operations on SVS.

SUBJECT 2: For Taxi OPS, some type of sensors to keep you from hitting other aircraft. This SVS will keep you on the concrete but you can still hit anything not in the terrain database.

SUBJECT 3: Actual NAV performance displayed versus required NAV performance would this a 9+.

SUBJECT 4: Ground equipment to aid in aircraft positioning. Expanded FOV to 180 degrees would aid in ground movement.

SUBJECT 5: NAV error alerting system. Does the A/C really know where it is or does it think it knows?

SUBJECT 6: (no comment)

SUBJECT 7: (no comment)

SUBJECT 8: (no comment)

SUBJECT 9: (no comment)

SUBJECT 10: FLIR and MM radar views ie. Real time info systems independent of a computed database.

SUBJECT 11: ensure data matches real world.

SUBJECT 12: (no comment)

SUBJECT 13: until the data integrity issue is resolved I couldn't be 100%.

SUBJECT 14: Add reliability/confidence builders – how close is computed position to actual? Differential GPS?

21. Please discuss whether SVS display concepts could be beneficial as a flight planning and “mission rehearsal” tool (e.g., rehearse an approach while in cruise through one of the multifunction displays).

SUBJECT 1: Only if reward is “top gun” video played on Size X after successful practice approach.

SUBJECT 2: Never thought of that – could be a great idea!

SUBJECT 3: Refer to 19.

SUBJECT 4: Very beneficial.

SUBJECT 5: For special qual airports, complex missed approaches, complex engine out procedures the system would be a great practice tool.

SUBJECT 6: Absolutely, especially in hazardous airport operations like Vail, CO.

SUBJECT 7: These could be adapted to home computer use and allow pilots to train themselves to a higher level than today’s standardized training programs. Big \$ savings here too while improving training.

SUBJECT 8: ?

SUBJECT 9: Could be useful on flights > 1 hr. Photorealistic must represent current conditions [sun angle, moon, diurnal and gnd cover (snow, etc)]

SUBJECT 10: Good tool for mission rehearsals on the ground-simulations. Impractical for use in flight. No way to manipulate simulation controls. However, it would be very useful to be able to run a “preview” of what the expected approach will look like – in flight.

SUBJECT 11: yes, currently being done in military

SUBJECT 12: I believe SVS displays would be extremely useful in special airport qualification training required by FARs also for refresher training when combined with outside view & simulator. Specific difficult approaches to short runways on those in mountainous terrain.

SUBJECT 13: Flight planning for route verification might be a use. I have never had a need for that example of rehearsing an approach in cruise. Rather than rehearsing per say. It could be used for a “visual” approach briefing which is now done verbally.

SUBJECT 14: One could certainly benefit from it as a briefing tool – show 3D depiction of approach for comparison to approach plate.

22. General Comments (or attach additional sheets):

SUBJECT 1: My HUD experience suggests average pilots can fly precise CAT II or lower approaches. The addition of SVS adds a huge amount of capabilities in terrain avoidance. If landing transition and ground OPS are proven (if not already), then you have taken the next big step in aviation safety.

SUBJECT 2: Overall, a very impressive system. General comments: Size matters – large display is better. Ghost airplane – very nice concept – easy to use. Symbology – just right – don't put any more clutter on HUD but no need to remove anything you have

SUBJECT 3: The HUD allowed me the greatest snap shot. I could fly the HUD and quickly scan the instruments to confirm. The X size was also good however I more easily adapted to the HUD.

SUBJECT 4: Overall, I think SVS is a great concept that needs to be implemented in the cockpit. I have some concerns though: First, in the simulator that I flew for the experiment, the approach and missed approach were already set up for me to fly, so the workload was relatively minimal. My concern is with the difficulty for the pilot to set up the approach: are the approaches in the database already? How easy is it for the pilot to change approaches at the last minute due to ATC request? Not all glass cockpits have approaches built into their FMC database. Regarding approaches that include visual maneuvers to the runway: the approach flown in the simulator had a right turn to line up on runway 7. This approach requires the pilot to be visual with the runway during the maneuver, but with the limited FOV in the simulator, the runway wasn't in sight until the final turn. ATC expects the pilot to maintain visual with the runway during the entire maneuver but SVS doesn't permit this. One solution is to increase FOV. I suggest SVS be used as an enhancement to straight-in approaches only until FOV can be expanded. Final comment goes back to pilot workload. It doesn't matter how great SVS is if using it or working with it is too complicated. If a pilot has to spend several minutes setting up his display for the approach then it is not an enhancement. If it is very easy to make a mistake setting up the approach then it is not an enhancement. I suggest focusing next experiment on pilot-SVS interface during approach set up. Have pilots setup several different approaches and evaluate them on speed and accuracy.

SUBJECT 5: SVS would or will be a great situational awareness enhancement tool when it is IMC outside.

The guidance cues will make many difficult engine out, missed approach or arrival maneuvers much easier provided the box is programmed correctly and the aircraft NAV is right on.

SUBJECT 6: Certain airports which seem to rely heavily upon visual approaches such as River visual into DCA and expressway visual 31 into LGA would be easier and safer with information such as what we have here. Especially in marginal VFR conditions it may serve as a backup tool when outside factors are present, such as at night, hazy weather or inexperience in operations to that airport.

SUBJECT 7: Continuation of question #2 – salient features = flight path vector (marker) with speed worm and energy carat are the most essential displays – they should be combined with a good steering cue like the NASA aircraft but when a turn is commanded the bank angle required for the turn should match the lines See diagram at left (drawn is a banked velocity vector with a ghost airplane with a hitch ball as a target. The wings of the velocity vector and the base of the ghost airplane are parallel which gives roll/bank guidance) – these diagrams are a slight change to the NASA cue in that the command circle that is placed in the center of the FPV is mounted below the bottom of the triangular steering cue. Pilots like to pull toward a cue and it also keeps the FPV symbol off the top of the steering command cue making it easier to watch the command cue.

SUBJECT 8: (no comment)

SUBJECT 9: (no comment)

SUBJECT 10: (no comment)

SUBJECT 11: (no comment)

SUBJECT 12: (no comment)

SUBJECT 13: (no comment)

SUBJECT 14: I personally prefer the generic for all presentations. Photorealistic is pretty, but could be confusing if the "photo" isn't realistic (ie, snowing? Dark or light?, etc). with a generic display you know it's a cartoon with salient features highlighted i.e. – blue river/stream, brown high terrain with a "green" valley/flat terrain, a few black shapes for buildings, etc) I think I'd transition more quickly from generic to actual than from "photorealistic" to reality. I thought the potential for these concepts to be limited only by the imagination of the user. Depending on the confidence level in the system used for determining present position, computed guidance and computed terrain modeling can essentially put visual flying into the PFD/ND. Collision avoidance, altitude excursion avoidance, crossing limitations; anything that can be

programmed or received from outside sources can be projected + improve SA. I'd be interested in seeing multiple, selectable approaches flown using SVS as compared to pilot performance using approach charts and NAVAIDS. Touch screen selectors for options and ranges would add ease-of-use. I'd add higher definition to the horizontal EGPWS depictions. A database that provides photo realistic or this level of generic display should be able to show a better "anti aliased" depiction of EGPWS data. The opaque nature of the HUD seems limiting to me. Could some sort of translucence be included? Maybe use a "scatter-dot" projection (does that make sense). Being able to see actual terrain through the projection would be confidence building. I'd recommend playing with different options for depicting the tunnel; maybe add some dots connecting corners of the path as shown on the screen. A bit more density might make it an easier reference. For the departure, a tunnel probably isn't appropriate but a simulated floor, maybe showing min terrain clearance altitude over the programmed ground track might help (or am I forgetting something you already have?)

REPORT DOCUMENTATION PAGE

*Form Approved
OMB No. 0704-0188*

The public reporting burden for this collection of information is estimated to average 1 hour per response, including the time for reviewing instructions, searching existing data sources, gathering and maintaining the data needed, and completing and reviewing the collection of information. Send comments regarding this burden estimate or any other aspect of this collection of information, including suggestions for reducing this burden, to Department of Defense, Washington Headquarters Services, Directorate for Information Operations and Reports (0704-0188), 1215 Jefferson Davis Highway, Suite 1204, Arlington, VA 22202-4302. Respondents should be aware that notwithstanding any other provision of law, no person shall be subject to any penalty for failing to comply with a collection of information if it does not display a currently valid OMB control number.
PLEASE DO NOT RETURN YOUR FORM TO THE ABOVE ADDRESS.

1. REPORT DATE (DD-MM-YYYY) 01-04-2004		2. REPORT TYPE Technical Publication		3. DATES COVERED (From - To)	
4. TITLE AND SUBTITLE Flight Simulator Evaluation of Synthetic Vision Display Concepts to Prevent Controlled Flight Into Terrain (CFIT)				5a. CONTRACT NUMBER	
				5b. GRANT NUMBER	
				5c. PROGRAM ELEMENT NUMBER	
6. AUTHOR(S) Arthur, Jarvis J., III; Prinzel, Lawrence J., III; Kramer, Lynda J.; Parrish, Russell V.; and Bailey, Randall E.				5d. PROJECT NUMBER	
				5e. TASK NUMBER	
				5f. WORK UNIT NUMBER 23-728-60-10	
7. PERFORMING ORGANIZATION NAME(S) AND ADDRESS(ES) NASA Langley Research Center Hampton, VA 23681-2199				8. PERFORMING ORGANIZATION REPORT NUMBER L-18365	
9. SPONSORING/MONITORING AGENCY NAME(S) AND ADDRESS(ES) National Aeronautics and Space Administration Washington, DC 20546-0001				10. SPONSOR/MONITOR'S ACRONYM(S) NASA	
				11. SPONSOR/MONITOR'S REPORT NUMBER(S) NASA/TP-2004-213008	
12. DISTRIBUTION/AVAILABILITY STATEMENT Unclassified - Unlimited Subject Category 03 Availability: NASA CASI (301) 621-0390 Distribution: Standard					
13. SUPPLEMENTARY NOTES An electronic version can be found at http://techreports.larc.nasa.gov/ltrs/ or http://ntrs.nasa.gov					
14. ABSTRACT The major hypothesis for a simulation experiment conducted at NASA Langley Research Center was that a Primary Flight Display (PFD) with synthetic terrain would improve pilots' ability to detect and avoid a potential Controlled Flight Into Terrain (CFIT) scenario compared to conventional instrumentation. All display conditions contained a Terrain Awareness and Warning System (TAWS) and a Vertical Situation Display (VSD) enhanced Navigation Display (ND). Each pilot flew twenty-two approach - departure maneuvers in Instrument Meteorological Conditions (IMC) to the terrain challenged Eagle County Regional Airport (EGE) in Colorado. For the final run, flight guidance cues were altered such that the departure path went into terrain. All pilots with a synthetic vision system (SVS) PFD (twelve of sixteen pilots) noticed and avoided the potential CFIT situation. The four pilots who flew the anomaly with the conventional baseline PFD configuration had a CFIT event. Additionally, all the SVS display concepts enhanced the pilot's situational awareness, decreased workload and improved flight technical error (FTE) compared to the baseline configuration.					
15. SUBJECT TERMS Synthetic vision systems; CFIT; Terrain awareness; Advanced displays; Flight simulation					
16. SECURITY CLASSIFICATION OF:			17. LIMITATION OF ABSTRACT	18. NUMBER OF PAGES	19a. NAME OF RESPONSIBLE PERSON
a. REPORT	b. ABSTRACT	c. THIS PAGE			STI Help Desk (email: help@sti.nasa.gov)
U	U	U	UU	127	19b. TELEPHONE NUMBER (Include area code) (301) 621-0390