

**I-AM-SAFE Feasibility Study Report**

**IAPA – ASARP Methodology  
for Safety net Assessment – Feasibility Evaluation**

**I-AM-SAFE Project**

---

Drafted by: Beatrice Raynaud

---

Authorised by: Thierry Arino on 21-03-2007

---

## RECORD OF CHANGES

Issue	Date	Detail of changes
0.1	15-11-2007	Initial draft of the report outline
0.2	29-01-2007	Revised structure following the third Progress Meeting held in November 2006; and material developed in Chapters 1, 2 and 3
0.3	16-02-2007	Minor changes in Chapters 1 and 3 following the fourth Progress Meeting held end of January 2007, and revised Chapter 2 with detailed material moved in Appendices
1.0	02-03-2007	Proposed first issue with executive summary, conclusions and recommendations
1.1	21-03-2007	Minor changes in all sections following EUROCONTROL comments

**IMPORTANT NOTE: ANY NEW VERSION SUPERSEDES THE PRECEDING VERSION, WHICH MUST BE DESTROYED OR CLEARLY MARKED ON THE FRONT PAGE WITH THE MENTION *OBSOLETE VERSION***

## EXECUTIVE SUMMARY

### **Scope and objectives**

In the context of STCA standardisation currently under progress in Europe, the I-AM-SAFE project evaluated the applicability and usefulness of the methodology used in the ACAS field in the prospect of establishing quantified performance requirements for STCA.

**I-AM-SAFE** stands for **IAPA – ASARP Methodology for Safety net Assessment – Feasibility Evaluation**.

The project represented about a one man-year effort between June 2006 and March 2007. The work was performed by a consortium of two organisations Sofréavia and DSNA involved in ACAS standardisation and safety evaluation for more than a decade.

### **Background and content**

This feasibility study built upon the experienced gained through the development of the ICAO performance SARPs for ACAS, and the methodology and tools that supported various ACAS safety and performance studies of the EUROCONTROL ACAS and Mode S Programme. These tools consist of a set of models that allow the replication of the environment in which ACAS is being operated in Europe, including the European 'safety encounter model' delivered by the ASARP project and the European 'ATM encounter model' delivered by the IAPA project.

For the I-AM-SAFE study purposes, a simplified STCA model has been implemented, which complies with the essential features of the reference STCA system defined by EUROCONTROL. This model was used to simulate STCA behaviour in encounters generated from the safety and ATM encounter models. Four sets of STCA configuration parameters were investigated during the study, which spanned the full range of parameter values recommended by EUROCONTROL. ACAS simulations were also performed to help assessing the relevance of the STCA alerts, identify missing alerts and provide elements on the STCA / ACAS interaction issue.

Because of the investigation nature of the project, the STCA performance metrics evaluated during the study were quite simple and did not yet consist of complex performance indicators. The focus was on the general trends that could be observed in terms of STCA alert occurrences, warning times and durations depending on the scenarios. An insight was also performed on the level of interaction with ACAS alerts.

### **Main study outcomes**

The study demonstrated the operational realism of the reference STCA model implemented during the project despite its simplicity. It also pointed out the potential interest of implementing other optional features described in the EUROCONTROL guidance material for STCA, as well as developing a surveillance model that would be representative of current surveillance performances in Europe.

The encounter model-based methodology has demonstrated to be applicable and useful to evaluate the performance of STCA, and the possible interaction issues with ACAS, although some adaptations would be required to specifically address STCA. In particular, the study results are in favour of the development of an ATC incident-based encounter model (derived from real incidents that occurred in Europe) that would encompass the interest of both the safety and ATM encounter models without their limitations.

Although quite simple, the STCA performance metrics evaluated during the study have shown the influence of the encounter characteristics (i.e. risk bearing situations or day-to-day conflicts in TMA or en-route), the STCA configuration (i.e. with or without the use of CFL) and parameters (i.e. high or low values), as well as the quality of the data provided to STCA, on the likelihood and relevance of the alerts. To allow evaluating the ability of STCA to alert the controller with sufficient warning time, the study results also pointed out the interest to model the controller intervention in response to an STCA alert apart from the encounter model itself.

### **Conclusions and recommendations**

This feasibility study confirms that the STCA standardisation process can benefit from the experience gained in the ACAS field. Indeed, both systems raise similar issues to a certain extent. Further, the possible interaction between the two safety nets is an area of concern that needs particular attention.

Taking into account the main study findings, a more sophisticated framework that would enable the evaluation of STCA performance and safety benefits while taking into account the effect of ACAS operations has been proposed. This framework builds upon the encounter model-based methodology and the various areas of improvement identified during the study.

For maximum safety benefits, it is recommended that the standardisation of STCA be supported by a comprehensive evaluation of the effectiveness of STCA and its possible interaction with ACAS.

## TABLE OF CONTENTS

<b>1. Introduction.....</b>	<b>11</b>
1.1. OBJECTIVE AND SCOPE.....	11
1.2. BACKGROUND AND CONTEXT.....	12
1.2.1. The role of STCA in the ATM system.....	12
1.2.2. State of the art on STCA performance harmonisation.....	12
1.2.3. The experience of ACAS standardisation.....	13
1.2.4. The evaluation of ACAS performances in Europe.....	13
1.3. DOCUMENT OVERVIEW.....	14
<b>2. Methodological elements of the feasibility study.....</b>	<b>15</b>
2.1. APPROACH.....	15
2.2. ATM AND SAFETY ENCOUNTER MODELS.....	16
2.3. REFERENCE STCA MODEL.....	16
2.4. BASIC STCA PERFORMANCE METRICS.....	17
<b>3. Main outcomes of the feasibility study.....</b>	<b>18</b>
3.1. GENERAL.....	18
3.2. RELEVANCE OF THE SIMPLIFIED STCA MODEL.....	19
3.2.1. Operational realism.....	19
3.2.2. Areas of improvements.....	20
3.3. RELEVANCE OF THE ATM AND SAFETY ENCOUNTER MODELS.....	21
3.3.1. Relevance the safety encounter model.....	21
3.3.2. Relevance the ATM encounter model.....	22
3.3.3. Relevance the CFL input model.....	23
3.3.4. Areas of improvements.....	24
3.4. LEVEL OF STCA PERFORMANCE EVALUATION.....	25
3.4.1. Relevance of the alert statistics.....	25
3.4.2. Relevance of the warning time metrics.....	26
3.4.3. Relevance of the STCA / ACAS interaction metrics.....	29
3.4.4. Areas of improvements.....	31

**4. Conclusions and recommendations ..... 32**

4.1. GENERAL ..... 32

4.2. MAIN STUDY OUTCOMES ..... 32

4.3. POSSIBLE FUTURE WORK ..... 33

4.4. RECOMMENDATIONS ..... 34

**5. References ..... 35**

5.1. REFERENCE DOCUMENTS ..... 35

5.2. I-AM-SAFE WORKING PAPERS ..... 35

**Appendix A. The Implications on ACAS Performances due to ASAS implementation Project..... 37**

**Appendix B. The ACAS Safety Analysis post-RVSM Project..... 39**

**Appendix C. Overview of the ATM and safety encounter models..... 41**

**Appendix D. Implementation of the reference STCA model ..... 43**

**Appendix E. Scenarios of STCA simulations..... 44**

**Appendix F. Description of the OSCAR encounter display ..... 45**

**LIST OF TABLES**

Table 1: STCA configuration parameters.....44

## LIST OF FIGURES

Figure 1: Framework for the evaluation of the safety of ACAS.....	14
Figure 2: Framework for the I-AM-SAFE feasibility study of STCA performances.....	15
Figure 3: Overview of the safety and ATM encounter sets.....	18
Figure 4: Illustration of a serious encounter with alert – High values of STCA parameters ...	19
Figure 5: Illustration of STCA behaviour in case of a slow convergence encounter .....	20
Figure 6: Alert occurrences with the safety encounter model.....	21
Figure 7: Alert severity breakdown with the safety encounter model.....	22
Figure 8: Alert occurrences with the ATM encounter model.....	22
Figure 9: Illustration of an encounter with a late horizontal manoeuvre.....	23
Figure 10: Illustrations of the effect of the CFL option on STCA behaviour .....	24
Figure 11: Alert severity breakdown with the ATM encounter model.....	25
Figure 12: Warning time distributions with the safety encounter model.....	27
Figure 13: Distribution of the actual warning time with the safety encounter model .....	28
Figure 14: Timing of STCA and RA alerts with the safety encounter model .....	29
Figure 15: STCA and ACAS alert occurrences with the ATM encounter model .....	30
Figure 16: Illustration of a TA encounter without STCA alert – High values of STCA parameters .....	30
Figure 17: Possible framework for the development of STCA performance requirements ....	33
Figure 18: Aircraft types per altitude layer in the ATM encounter model .....	41
Figure 19: Aircraft types per altitude layer in the safety encounter model .....	42
Figure 20: Simplified STCA model design .....	43
Figure 21: OSCAR symbols for the I-AM-SAFE study .....	45
Figure 22: OSCAR symbols for ACAS simulation results.....	45

## ACRONYMS

ACAS	Airborne Collision Avoidance System
ANSPs	Air Navigation Service Providers
ASARP	ACAS Safety Analysis post-RVSM Project
CFL	Clear Flight Level
CPA	Closest Point of Approach
CPP	Closest Point of Proximity
FL	Flight Level
HMD	Horizontal Miss Distance
I-AM-SAFE	IAPA - ASARP Methodology for Safety nets Assessment - Feasibility Evaluation
IAPA	Implications on ACAS performances due to ASAS implementation project
OSCAR	Offline Simulator for Collision Avoidance Resolution
RA	Resolution Advisory
SARPs	Standards and Recommended Practices
STCA	Short-Term Conflict Alert
TA	Traffic Advisory
TCAS	Traffic Collision Avoidance System
TMA	Terminal Area
TOV	Time Of (separation) Violation
VMD	Vertical Miss Distance



## GLOSSARY

ACAS	<p>Airborne Collision Avoidance System – a system standardised in the ICAO SARPs that uses transponder replies from other aircraft to warn the pilot of a risk of impending collision</p> <p>Hereafter, ACAS always refers to ACAS II – a system that generates traffic advisories (TAs) and also generates resolution advisories (RAs) in the vertical plane.</p>
ACASA project	<p>ACAS Analysis – a study commissioned by EUROCONTROL in support of the mandate for the carriage of ACAS II in Europe, before implementation of RVSM.</p>
ASARP project	<p>ACAS Safety Analysis post-RVSM Project – a study commissioned by EUROCONTROL to investigate the safety of ACAS following the introduction of RVSM in Europe.</p>
ATM encounter model	<p>A mathematical model which reproduces the distributions and interdependencies of the parameters characterising encounters likely to occur in the ATM operations.</p> <p>The encounters that matters are conflict situations (involving two aircraft) that can be observed in daily ATM operations. These encounters can include one or more aircraft manoeuvres that preserve ATC separation.</p> <p>The IAPA project used European radar data to derive an ATM encounter model of the aircraft operations as observable at the time of the project, viz. the IAPA ATM encounter model.</p>
IAPA project	<p>Implications on ACAS Performances due to ASAS implementation – a study commissioned by EUROCONTROL to assess the effect that the introduction of ASAS procedures might have on ACAS operations.</p>
I-AM-SAFE project	<p>IAPA - ASARP Methodology for Safety nets Assessment - Feasibility Evaluation– a study commissioned by EUROCONTROL to assess the applicability and usefulness of the methodology used in the ACAS field in the prospect of establishing performance requirements for STCA.</p>
Proximity	<p>Distance between two aircraft that scales the horizontal and vertical distances between the aircraft according to the respective separation minima applicable by ATC.</p> <p>Hereafter, the ATC separation minima are assumed to be 1,000 feet in the vertical dimension and respectively, 3 Nm in TMA and 5 NM in en-route, for the horizontal plane.</p>

---

Safety encounter model	<p>A mathematical model which reproduces the distributions and interdependencies of the parameters characterising risk bearing encounters likely to occur in ATM operations.</p> <p>The encounters that matters are those in which two aircraft are on a close encounter course and in which there exist a risk of mid-air collision or in which the response of pilots to ACAS RAs can result in a risk of mid-air collision.</p> <p>The ASARP project used post-RVSM radar data to update the ACASA safety encounter model and produced the post-RVSM European safety encounter model, viz. the ASARP safety encounter model.</p>
Serious encounter	<p>Encounter with a serious infringement of separation between two aircraft, i.e. less than half the separation minima applicable by ATC at the “Closest Point of Proximity” (CPP) with a tolerance margin of 250 feet applied on the vertical separation between two level aircraft at adjacent FLs.</p>
STCA	<p>Short-Term Conflict Alert – a ground-based safety net that alerts controllers of potential or actual infringement of separation minima, of which several implementations exist in the ECAC area covering a wide range of options and parameter values.</p> <p>“A ground-based safety net intended to assist the controller in maintaining separation between controlled flights by generating, in a timely manner, an alert of potential or actual infringement of separation minima.” [STCA1]</p> <p>Hereafter, STCA refers to a generic STCA implementation developed for the study purposes based on the EUROCONTROL Guidance Material for STCA [STCA2].</p>
TCAS	<p>Traffic alert and Collision Avoidance System – an aircraft equipment that is an implementation of an ACAS</p> <p>Hereafter, TCAS refers to TCAS II, version 7.0 – the equipment that complies with the ICAO SARPs and whose carriage and operation is mandatory for many aircraft in Europe.</p>
Warning time	<p>“The amount of time between the first indication of an alert to the controller and the predicted violation of the applicable separation minima.” [STCA1]</p> <p>Hereafter, different alternatives of warning time metric are being proposed and evaluated against operational relevance, in particular in encounters that include a controller intervention.</p>

## 1. Introduction

### 1.1. Objective and scope

- 1.1.1. The '**Short-Term Conflict Alert**' (STCA) system is a ground-based safety net intended to assist the controller in preventing collision between aircraft. There exist several STCA implementations in the States of the European Civil Aviation Conference (ECAC) area with no uniform procedures for operational use, optimisation and validation. Under the leadership of the SPIN (Safety nets: Planning Implementation and eNhancement) Task force of EUROCONTROL, STCA standardisation is progressed in Europe.
- 1.1.2. The airborne safety net, i.e. the '**Airborne Collision Avoidance System**' (ACAS), is being operated world-wide regardless of the Air Navigation Services provided in the airspace. To ensure global effectiveness of ACAS, the ICAO Standards And Recommended Practices (SARPs) define ACAS minimum performance requirements together with a methodology to check compliance with these requirements.
- 1.1.3. This methodology has been applied and refined in various ACAS safety and performance studies of the EUROCONTROL Mode S and ACAS Programme. These include the 'Implication on ACAS Performances due to ASAS implementation' (IAPA) project and the 'ACAS Safety Analysis post-RVSM Project' (ASARP).
- 1.1.4. The objective of the I-AM-SAFE study is to assess the applicability and usefulness of the methodology used in the ACAS field, in the prospect of establishing quantified performance requirements for STCA.
- 1.1.5. **I-AM-SAFE** stands for **IAPA – ASARP Methodology for Safety net Assessment – Feasibility Evaluation**.
- 1.1.6. The study represented about a one man-year effort between June 2006 and March 2007. The work was performed by a consortium of two organisations, i.e. Sofréavia<sup>1</sup> and DSNA<sup>2</sup>, involved in ACAS standardisation and safety evaluation for more than a decade.

---

<sup>1</sup> Sofréavia is an engineering and consulting company in the fields of airport, ATM and air transport industries. Its clients include EUROCONTROL, air navigation services providers, civil aviation administrations and industry.

<sup>2</sup> The 'Air Navigation Services Department' (DSNA) is part of the French civil aviation administration and provides air navigation services in the French airspace as well as in the French overseas territories airspace.

## **1.2. Background and context**

### **1.2.1. The role of STCA in the ATM system**

- 1.2.1.1. EUROCONTROL defines STCA as “a ground-based safety net intended to assist the controller in maintaining separation between controlled flights by generating, in a timely manner, an alert of potential or actual infringement of separation minima” [STCA1]. This definition is derived from the procedures for STCA defined in the ICAO PANS-ATM (cf. Doc4444, §15.6.2, Note 1).<sup>3</sup>
- 1.2.1.2. In the event of an alert, the controller is expected to “assess without delay the situation and if necessary take action to ensure that the applicable separation minimum will not be infringed or will be restored.” (cf. Specific Requirement STCA-05 in [STCA1]).
- 1.2.1.3. As a safety net, the role of STCA in “maintaining separation between controlled flights” should not be a prerequisite for the provision of safe separation services by Air Traffic Control (ATC). However when considering the overall level of safety achieved by ATC, the additional safety margins provided by STCA are taken into account.
- 1.2.1.4. It is essential that the controller intervention in response to STCA is as far as practicable effective before entering the intervention timeframe of the airborne safety net, i.e. ACAS, in order to maximise the safety benefits of both.

### **1.2.2. State of the art on STCA performance harmonisation**

- 1.2.2.1. A full-scale investigation of the current practices related to STCA (and other safety nets) in the States of the ECAC area has been conducted by EUROCONTROL [SNETS]. Several areas of concern were identified, for which best practices did not necessarily exist in the state of the art.
- 1.2.2.2. This survey highlighted, among others, that there were no harmonised or uniform optimisation procedures and validation criteria associated with the ground safety nets. Further, the understanding and management of possible interactions between STCA and ACAS was identified as an area of concern that would deserve further investigation.
- 1.2.2.3. Operational requirements for Safety Nets, including STCA, were defined in the EATCHIP Phase III [ORD] Volume 2. More recently, the EUROCONTROL Specification for STCA [STCA1] has defined minimum requirements for the development and use of STCA in the Europe. To achieve the more technical of these requirements, comprehensive guidance material for a reference STCA system [STCA2] has also been released, which defines principles for STCA parameter optimisation.
- 1.2.2.4. With these high-level requirements on STCA capabilities, the ECAC-wide standardisation of STCA is progressing. However, a long path still remains to be done to develop quantified performance requirements ensuring an agreed level of effectiveness of STCA. For increasing this effectiveness, it will be essential that these performance requirements also take into account the operation of ACAS.

---

<sup>3</sup> Note that, at the time of publication of this report, there is already agreement to change both documents to read “... assist the controller in preventing collision between aircraft by generating ...” in order to better reflect the intended use of STCA.

### 1.2.3. The experience of ACAS standardisation

- 1.2.3.1. ICAO defines ACAS as “an aircraft system based on secondary surveillance radar (SSR) transponder signals which operates independently of ground-based equipment to provide advice to the pilot on potential conflicting<sup>4</sup> aircraft that are equipped with SSR transponders” (cf. ICAO Annex 2 – Rules of the Air).
- 1.2.3.2. ACAS is not designed, nor intended, to achieve any specific ‘Target level of Safety’ (TLS). Instead, the safety benefit afforded by the deployment of ACAS is usually expressed in terms of a ‘risk ratio’ that compares the risk of a ‘Near Mid-Air Collision’ (NMAC) both with and without ACAS. ICAO has defined a set of target ‘risk ratios’ for different scenarios of aircraft equipage in a theoretical airspace described by a ‘safety encounter model’ (cf. ICAO Annex 10).
- 1.2.3.3. ICAO also defines an ‘ATM encounter model’ whose structure derives from that of the ‘safety encounter model’, but which enlarges the featured encounters to situations where the aircraft pass each other with some horizontal miss distance. This encounter model has been used to standardise ATM compatibility requirements for ACAS through the definition of target ratios of nuisance alerts.

### 1.2.4. The evaluation of ACAS performances in Europe

- 1.2.4.1. The framework initiated by at the ICAO level when defining ACAS minimum performances has been further developed through various ACAS-related projects in Europe. These projects include the ‘full-system safety study’ completed in the ‘ACAS Analysis’ (ACASA) project [ACA1a], [ACA1b] performed in support to the mandates for the carriage of ACAS II in Europe, and more recently the ‘ACAS Safety Analysis post-RVSM’ (ASARP) Project. The main findings of the ASARP project are briefly described in Appendix B of this document.
- 1.2.4.2. These projects delivered a comprehensive framework that includes a set of models that allow the replication of the environment in which ACAS is being operated in Europe. These models consist essentially of a ‘**safety encounter model**’, models of pilot reaction in response to RAs and a model of altimetry errors applicable in the European airspace.
- 1.2.4.3. As shown in Figure 1, these models are used to determine the risk that remains when ACAS is being operated. Distinction is made between the ‘logic system risk’ that consider the risk associated with the operation of ACAS in the modelled airspace and the ‘full-system risk’ that also takes into account other hazards that may affect the safety of ACAS.
- 1.2.4.4. The ‘logic system risk’ is usually determined through the performance of ACAS simulations that include the modelling of pilot response to RAs in a large set of modelled encounters, whereas the ‘full-system risk’ is usually determined using a ‘contingency tree’ that combines pure ACAS logic risks and hazards probabilities (e.g. ACAS fails to track an intruder, or the pilot prefers not to follow an RA and exercise see-and-avoid).

---

<sup>4</sup> In the context of ACAS, ‘conflicting aircraft’ is related to a risk of collision and not to the predicted violation of the separation minima applicable in the airspace by the Air Traffic Control services.

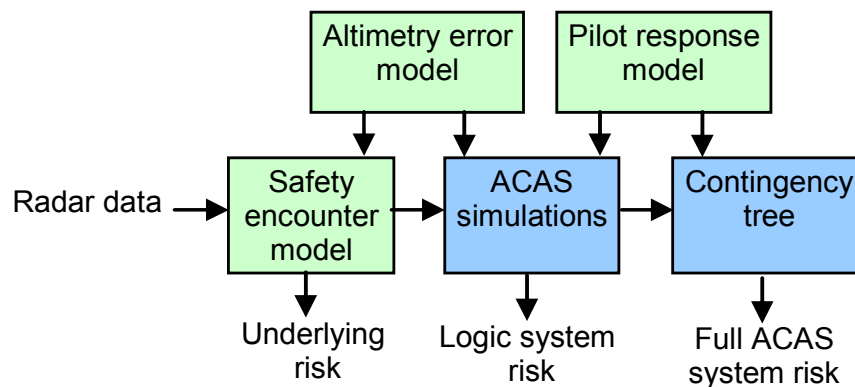

**Figure 1: Framework for the evaluation of the safety of ACAS**

- 1.2.4.5. Within the scope of the IAPA project, the framework for the evaluation of the performances of ACAS was enriched with the delivery of an '**ATM encounter model**' featuring the current ATM operations in Europe (see Appendix A for further details).
- 1.2.4.6. The IAPA ATM encounter model is a powerful tool for evaluating ATM changes and their potential interaction with ACAS. Its scope is far greater than that of the ICAO ATM encounter model and its usefulness extends beyond just the study of the 'Implication on ACAS Performances due to ASAS implementation' made in the project.

### **1.3. Document overview**

- 1.3.1. The document is organised into four chapters, including this **Chapter 1** on the scope and context of the I-AM-SAFE study.
- 1.3.2. **Chapter 2** presents the methodological elements and tools that were evaluated in this feasibility study. These include the safety encounter model recently updated in the ASARP project, the ATM encounter model developed in the IAPA project, an implementation of the reference STCA system defined by EUROCONTROL and a set of basic STCA performance metrics defined for the purposes of the I-AM-SAFE study.
- 1.3.3. **Chapter 3** evaluates the applicability and usefulness of this methodological framework for evaluating the safety benefits and performances of STCA. This evaluation is supported by the analysis of the main STCA and ACAS simulations results analysed during the study.
- 1.3.4. Finally, **Chapter 4** concludes the document with the main study findings and makes some recommendations for possible future work that would support the STCA standardisation process.

## 2. Methodological elements of the feasibility study

### 2.1. Approach

2.1.1. The following figure provides an overview of the overall approach taken in the I-AM-SAFE study.

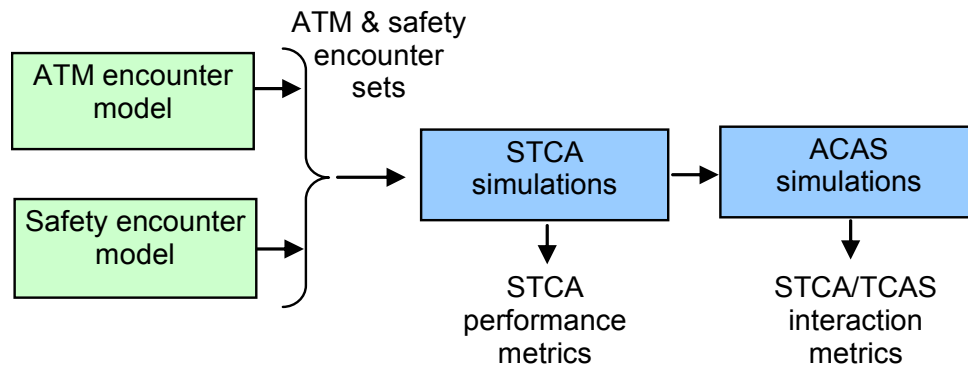

Figure 2: Framework for the I-AM-SAFE feasibility study of STCA performances

- 2.1.2. This approach builds on the methodology and tools that supported previous ACAS studies in Europe, and notably on the European ‘safety encounter model’ delivered by the ASARP project and the European ‘ATM encounter model’ delivered by the IAPA project.
- 2.1.3. For the purposes of the study, a simplified STCA model has been implemented according to the EUROCONTROL guidance material for a reference STCA system [STCA2]. This model was used to simulate STCA behaviour in encounters generated from the two encounter models. Four sets of STCA configuration parameters were investigated, which spanned the full range of values recommended for use in the EUROCONTROL guidance material (see Appendix E for further details).
- 2.1.4. Because of the investigation nature of the I-AM-SAFE project, the STCA performance metrics evaluated during the study were quite simple and did not yet consist of complex performance indicators such as ratios of “wanted alerts”, “nuisance alerts”, “missed alerts” or “adequate warning time”, etc. The computation of such performance indicators would require a precise and unambiguous classification of alerts and encounter situations. This was clearly out of the scope of the I-AM-SAFE feasibility study.
- 2.1.5. Finally, ACAS simulations were also performed to help assessing the relevance of the STCA alerts, identify missing alerts and provide elements on the STCA / ACAS interaction issue. These simulations were conducted using the “Off-line Simulation for Collision Avoidance Logic” [OSCAR]. This test-bench includes an implementation of the TCAS II logic Version 7.0 that conforms to the TCAS Minimum Operation Performance Standards developed by RTCA-SC147 [TCAS]. Although possible with the OSCAR test-bench, no pilot reaction in response to the RAs was included in the simulations.

## 2.2. *ATM and Safety encounter models*

- 2.2.1. The 'ATM encounter model' and the 'safety encounter model' are mathematical models, which capture the properties of encounters that are representative of ATM operations in Europe. Their main advantage is that they can be used to generate an arbitrarily large set of encounters whose properties are characteristic of the European airspace.
- 2.2.2. Although they share the same general features and advantages, the encounters that matters are different for each of the two models:
- The 'ATM encounter model' characterises **day-to-day encounters** involving two aircraft in conflict. The encounters that matters correspond to situations in which the ATC separation minima are generally preserved, possibly thanks to one or more aircraft manoeuvres that ensure separation.
  - The 'safety encounter model' is focused on **risk bearing encounters** involving two aircraft on a close encounter course. The encounters that matters are those in which there exists a risk of mid-air collision or in which the response of pilots to ACAS RAs can result in a risk of mid-air collision.
- 2.2.3. Based on the radar data used to build the models, it can be estimated that the encounters captured by the 'ATM encounter model' occur about 4 times every flight-hour in Europe, whereas those captured by the 'safety encounter model' occur about once every 6,045 flight-hours (or every 2 days of observation by a typical radar) in Europe.
- 2.2.4. The main characteristics of the encounters whose properties are captured by the 'ATM encounter model' and the 'safety encounter model' are further described in Appendix C.

## 2.3. *Reference STCA model*

- 2.3.1. The STCA model developed in support to the study is consistent with the main requirements defined in the EUROCONTROL guidance material for a reference STCA system [STCA2].
- 2.3.2. The model was deliberately kept as simple as possible and only includes one of the optional features defined in the EUROCONTROL guidance material, i.e. the possible use of the 'Cleared Flight Level' (CFL) in the vertical prediction of the 'Linear Prediction Filter' (see Appendix D for further details).
- 2.3.3. To verify the correctness of the implementation, some validation work was conducted in two steps [WP08], [WP10]:
- A first series of tests, based on the validation scenarios defined in the EUROCONTROL guidance material, aimed at checking the conformity of the STCA model implementation to the requirements defined for the reference STCA system;
  - A second step, based on a sample of encounters extracted from both the ATM and the safety encounter models and performed together with an Air Traffic Controller, aimed at assessing the correctness of the alerts, or lack thereof, issued by STCA model, taking into account the dynamics of the encounters.



- 2.3.4. The validation effort helped gaining confidence in the STCA model implementation. It was also an opportunity to evaluate its behaviour in different encounter geometries and with different sets of STCA configuration parameters.

## **2.4. Basic STCA performance metrics**

- 2.4.1. A set of basic STCA performance metrics have been investigated<sup>5</sup> during the study [WP07], which were related to the encounters themselves, the alert occurrences, the warning times associated with the alerts, and the alert durations. To investigate the STCA / ACAS interaction issue, basic metrics were also defined, which related to the occurrences and timing of the alerts issued by the two safety nets.
- 2.4.2. Basically, three classes of encounters were considered as follows:
- Serious encounters with less than half the ATC separation minima:  
( $HMD < \frac{1}{2} \text{ sep min}$ ) AND ( $VMD < \frac{1}{2} \text{ sep min}$ )
  - Non-serious encounters with a separation infringement but more than half the ATC separation minima:  
[ $\frac{1}{2} \text{ sep min} \leq HMD < \text{ sep min}$ ] AND ( $VMD < \text{ sep min}$ )  
OR  
[( $HMD < \text{ sep min}$ ) AND ( $\frac{1}{2} \text{ sep min} \leq VMD < \text{ sep min}$ )]
  - Encounters without separation infringement:  
( $\text{ sep min} \leq HMD$ ) OR ( $\text{ sep min} \leq VMD$ )
- 2.4.3. The separation minima applicable by ATC were assumed to be 1,000 feet<sup>6</sup> in the vertical dimension and respectively 3 NM in TMA and 5 NM in en-route for the horizontal plane. For the sake of simplicity, the encounter classification was determined at the 'Closest Point of Proximity' (CPP).
- 2.4.4. Although simpler than the five encounter categories defined in [STCA2], this classification was considered relevant enough for the purposes of the I-AM-SAFE study.

---

<sup>5</sup> These performance metrics were computed using an ad-hoc tool called STCA\_SARPS. Basically, this tool processes the log files of the STCA simulations and the encounter files and produces an output file with the computed statistics.

<sup>6</sup> A tolerance margin of 250 feet was allowed on the vertical separation between two level aircraft at adjacent FLs. Level aircraft were assumed to fly with a vertical rate lower than 200 fpm at closest approach.

### 3. Main outcomes of the feasibility study

#### 3.1. General

3.1.1. The I-AM-SAFE study evaluated the applicability and the usefulness of the encounter-model approach, and the relevance of the various elements of the proposed framework, for the evaluation of STCA performances.

3.1.2. To do so, two encounter sets were generated using respectively the 'safety encounter model' and the 'ATM encounter model':

- 200,000 safety encounters representing about  $12.09 \times 10^8$  flight hours or about 100 years of ECAC traffic (assuming 12.5 million flight hours per year in the ECAC area); and
- about 440,000 ATM encounters<sup>7</sup> representing about 110,090 flight-hours or 3 days of ECAC traffic (assuming 12.5 million flight hours per year in the ECAC area).

3.1.3. Both encounter sets correspond to a different breakdown in terms of altitude distribution, and more important for the I-AM-SAFE study purposes, in terms of proportions of separation infringements as follows:

- about half of the safety encounters correspond to a separation infringement (i.e. 20% of the TMA encounters and 14% of the en-route encounters with a serious infringement and 37% of TMA encounters and 36% of en-route encounters with a non-serious infringement);
- almost all ATM encounters correspond to a situation without any separation infringement (i.e. only 0.3% of the TMA encounters and 0.03% of the en-route encounters with a serious infringement and 1.1% of TMA encounters and 0.37% of en-route encounters with a non-serious infringement).

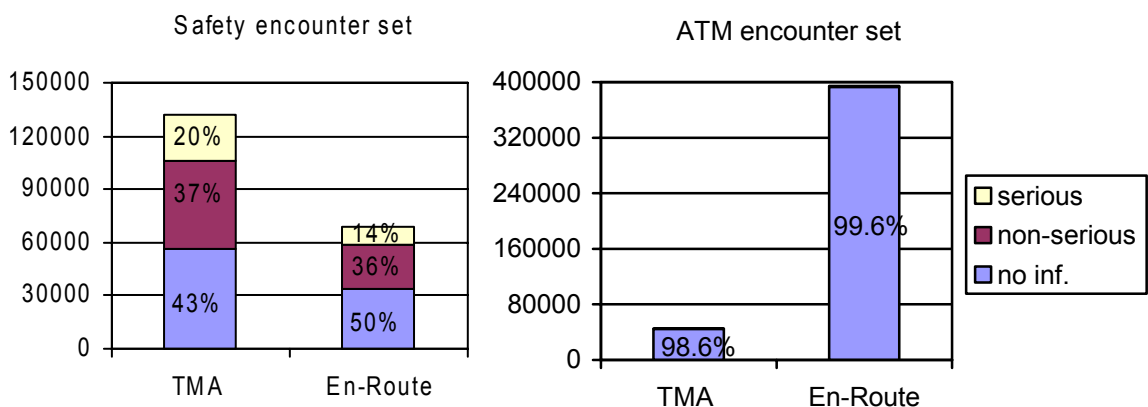

Figure 3: Overview of the safety and ATM encounter sets

3.1.4. When analysing the simulation results observed for each of these encounter sets, the focus was on the general trends that could be observed in terms of STCA alert

<sup>7</sup> These encounters result from the filtering of well-centered encounters (i.e. with a CPP at  $t=240$  seconds  $\pm 10$  seconds) among an initial set of 800,000 encounters generated from the IAPA ATM encounter model.

occurrences, warning times and durations depending on the scenarios. An insight was also performed on the level of interaction with ACAS alerts.

- 3.1.5. The study also investigated the effect of possibly influencing factors, including the STCA configuration parameters, the origin of the encounters (i.e. the ATM or the safety encounter model) and their severity in terms of separation infringement at closest approach.
- 3.1.6. The main outcomes of the study are presented hereafter together with some simulation results and illustrative examples of simulated encounters shown using the display facilities of the OSCAR test-bench (see Appendix F for further details).

### 3.2. Relevance of the simplified STCA model

#### 3.2.1. Operational realism

- 3.2.1.1. First the study demonstrated the operational realism of the implementation of the reference STCA model despite its simplicity. The following figure is an illustration of a safety encounter for which an alert was simulated (using high values of STCA configuration parameters).

Note: The figure presents the aircraft trajectories of the aircraft versus time, as well as the STCA simulation results indicated on the trajectory of the first aircraft (in red).

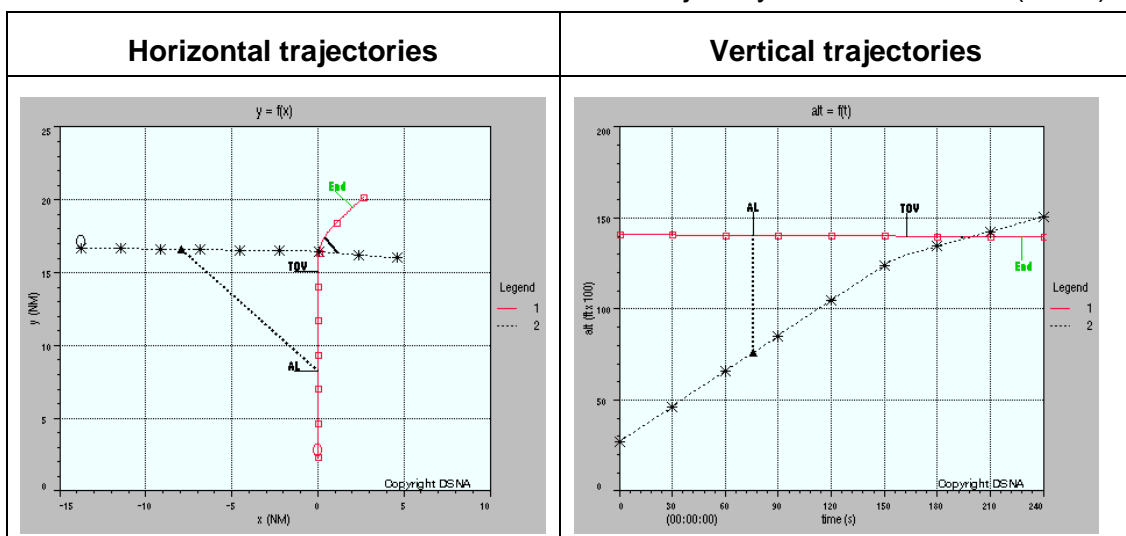

**Figure 4: Illustration of a serious encounter with alert – High values of STCA parameters**

- 3.2.1.2. During the operational validation of this implementation, some specific behaviours were identified that were fully consistent with the specifications of the STCA model, but that could be considered undesirable from a controller's point of view.
- 3.2.1.3. These included the simulation of some non-continuous alerts with one or more intermediate switch-offs before the end of the conflict. This behaviour essentially resulted from the quantisation of the input surveillance data (e.g. the altitude quantisation in 25 ft) during encounters with a small overlap between the intervals of lateral and vertical separation violation determined by the 'Linear Prediction Filter'.
- 3.2.1.4. The proportion of non-continuous alerts observed in simulation (i.e. between 2% and 3% depending on the encounter set and the STCA parameters) possibly under estimate the actual rate of occurrence of such alerts due to the study assumptions for perfect surveillance data.

3.2.1.5. Other encounters were observed triggering an alert on-time (according to the parameters of the 'Linear Prediction Filter'), but which could be considered late from an operational perspective. This was particularly the case for slow convergence encounters in which the alert was delayed (typically, when using the low values of STCA configuration parameters) beyond the infringement of the ATC separation minima.

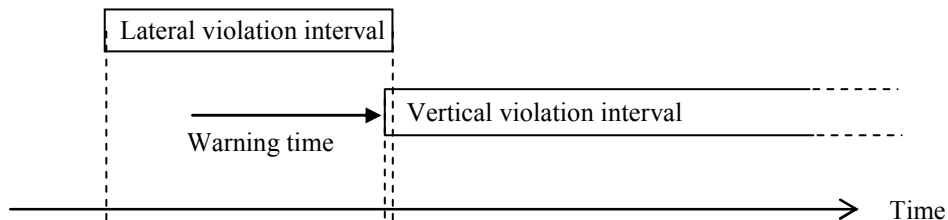

**Figure 5: Illustration of STCA behaviour in case of a slow convergence encounter**

3.2.1.6. It should be noted that, in these situations, the use of greater parameters by the 'Linear Prediction Filter' proved to move backward the predicted instant the lateral and vertical separation violation, and therefore, the timing of the STCA alert.

3.2.1.7. The possibly reduced effectiveness of STCA in vertical and horizontal slow convergence situations is a known issue. A number of possible mitigation means exists, including the use of a 'Current Proximity Filter', vertical rate tolerances and algorithms to recognise slow closing conditions and increase the STCA protection volume accordingly.

3.2.1.8. None of these features were implemented in the STCA model. Therefore the study might slightly over-estimate the rate of alerts that are issued later than desired (see sections 3.4.2 and 3.4.3). This impact should nevertheless be limited since slow convergence situations are not the most frequent encounters.

### **3.2.2. Areas of improvements**

3.2.2.1. The study highlighted the influence of the input surveillance data on the STCA alerts. To improve the realism of the data provided to STCA, it might be of interest to implement a surveillance model that would be representative of current surveillance performances in Europe. Performance aspects that might require specific attention include the accuracy and the latency of the tracks information provided to STCA (e.g. position errors resulting from the late detection of manoeuvring aircraft, etc).

3.2.2.2. Some consideration might also be given to the implementation of the various options described in the EUROCONTROL guidance material [STCA2], e.g. the 'Current Proximity Filter' (option B) or the 'Turning Prediction Filter' (option C), since they may improve the behaviour of the STCA model in specific encounter situations. Another optional feature that exists in some STCA systems which can overcome some of the problems of late alerts when the aircraft are vertically slow closing is the use of vertical rate uncertainties.

### 3.3. Relevance of the ATM and safety encounter models

#### 3.3.1. Relevance the safety encounter model

3.3.1.1. The safety encounter model proved to be more appropriate than the ATM encounter model for evaluating the safety benefits of STCA since it provided a larger number of relevant encounters. As an illustration, Figure 6 shows the number and the percentage of alerts observed with the safety encounters depending on the considered airspace (i.e. TMA or en-route) and the scenario of STCA configuration.

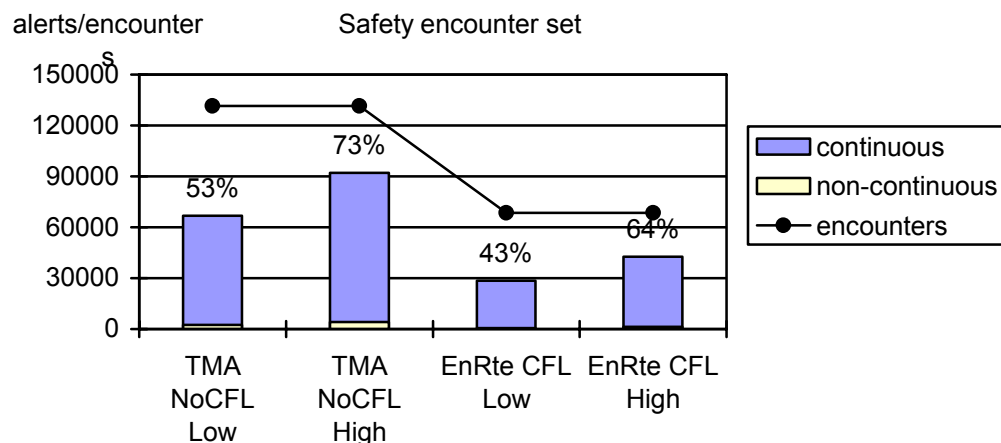
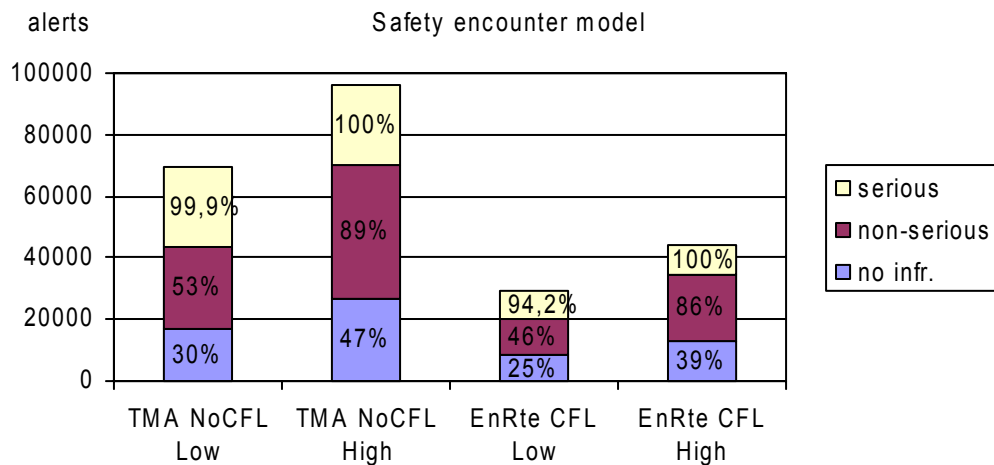

Figure 6: Alert occurrences with the safety encounter model

- 3.3.1.2. It should however be noted that these results overestimate the alert rate in current ATM operations since the safety encounter model is focused on situations where aircraft are on a collision course (with almost no horizontal miss distance at CPA).
- 3.3.1.3. Hence the safety encounter model has shown limited interest for assessing the compatibility of STCA with current controllers working methods for maintaining aircraft separation. This was only possible, to a certain extent, for encounters in which the controllers would have chosen to maintain or restore vertical separation between the aircraft (see examples in Figure 10).
- 3.3.1.4. Due to the great likelihood of safety encounters that include a vertical manoeuvre likely to stand for a controller intervention, the classification of alerts performed using the achieved separation (as a result of these manoeuvres) also exaggerated the number of nuisance alerts, i.e. the occurrences of alerts in encounters eventually resulting in a non-serious separation infringement or even without any separation infringement.
- 3.3.1.5. This issue is highlighted in Figure 7, which presents the alert severity breakdown observed for the scenarios investigated with the safety encounter model. Since the TMA and en-route encounter sets consisted of distinct proportions of encounters of a given severity, the percentages of encounters triggering an alert are also provided for each type of encounter severity.

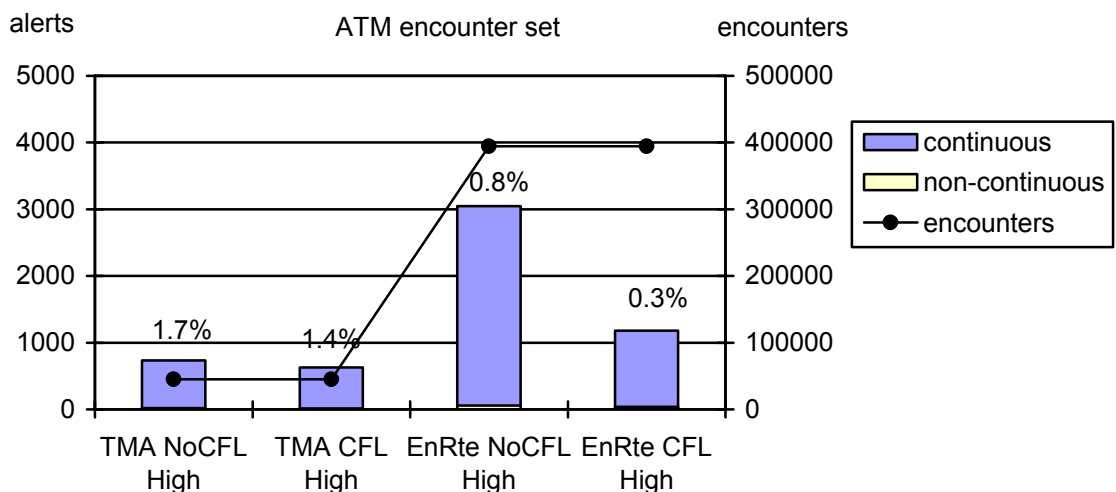

**Figure 7: Alert severity breakdown with the safety encounter model**

3.3.1.6. As shown, these simulation results are characterised by a significant proportion (i.e. between 25% and 47% depending on the scenario) of encounters without any separation infringement, but with an alert being issued.

### 3.3.2. Relevance the ATM encounter model

3.3.2.1. The ATM encounter model proved to be of interest for evaluating the compatibility of STCA with day-to-day ATM operations, but of limited interest for evaluating STCA performances on a quantitative basis. Its main characteristic is the small number of alerts simulated whatever the scenario of STCA configuration and parameters, as shown in Figure 8.



**Figure 8: Alert occurrences with the ATM encounter model**

3.3.2.2. The encounters whose properties are being captured by the ATM encounter model also raised the issue of alert classification in case of manoeuvres likely to stand for a controller intervention (either in the horizontal or vertical plane within the ATM encounter model). Figure 9 is an illustration of a heading change (occurring after the issuance of an STCA alert) that increases the aircraft separation at closest approach, thus impacting the severity associated with the alert.

**Note:** The figure presents the aircraft trajectories of the aircraft versus time, as well as the STCA and ACAS simulation results indicated on the trajectory of the first aircraft (in red). The simulated ACAS intruder status is indicated on the trajectory of the intruder aircraft (in black).

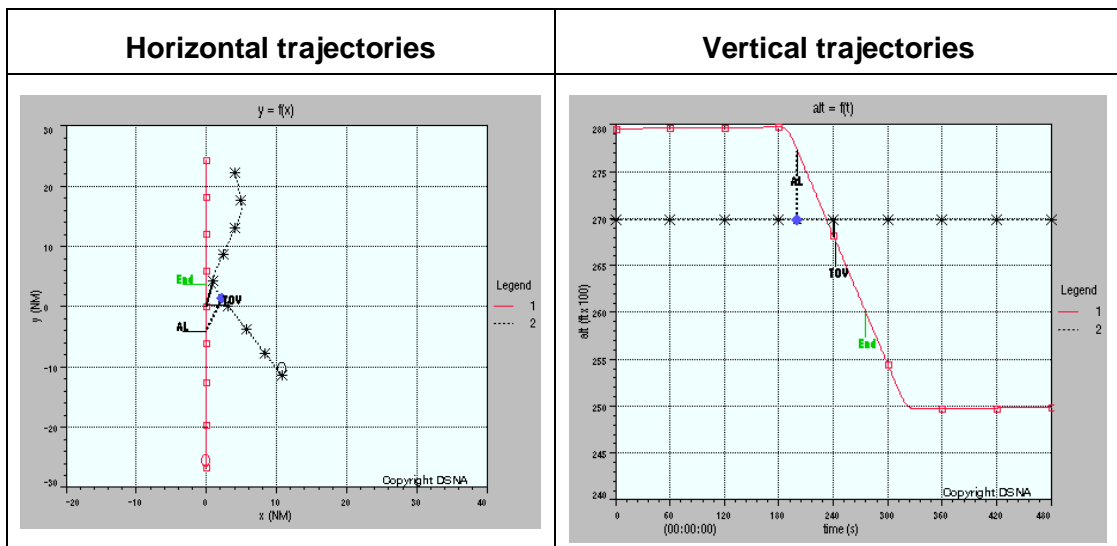

**Figure 9: Illustration of an encounter with a late horizontal manoeuvre**

3.3.2.3. These results once again highlight how much the scope of the encounter model is essential to allow for the determination of realistic alert rates and appropriate alert classification.

### 3.3.3. Relevance the CFL input model

3.3.3.1. The simulation results based both on the safety and the ATM encounter models showed the influence of the use of CFL on the issuance of alerts, as well as their operational relevance and effectiveness in terms of warning time. This influence was notably observed within two encounter geometries illustrated in Figure 10, i.e.:

- level-off encounters in which the use of the CFL by STCA prevented the issuance of unnecessary alerts between aircraft eventually vertically separated by 1,000 ft (or even 2,000 ft, when using high values of STCA configuration parameters); and
- altitude bust encounters in which the use of the CFL delayed the issuance of desirable alerts after the infringement of the vertical separation minimum of 1,000 ft.

3.3.3.2. It should be noted that the use of CFL by the 'Linear Prediction Filter' creates some discrepancy between the STCA and ACAS systems, the latest being a safety net fully independent from ATC. This feature was pointed out in many 1,000 ft level-off encounters that triggered ACAS RAs on board the aircraft whereas the STCA alert was filtered by the use of the CFL option.

3.3.3.3. With regard to level-bust encounters, the study highlighted that the use of the CFL is likely to impact the effectiveness of STCA in alerting the controller with sufficient warning time to maintain separation. It should however be noted that this reduced effectiveness only affected a small amount of encounters (at least, according to the encounters captured by the safety encounter model).

**Note:** The figure presents the vertical trajectories of the aircraft versus time, as well as the STCA and ACAS simulation results indicated on the trajectory of the first aircraft (in red). The simulated ACAS intruder status is indicated on the trajectory of the intruder aircraft (in black).

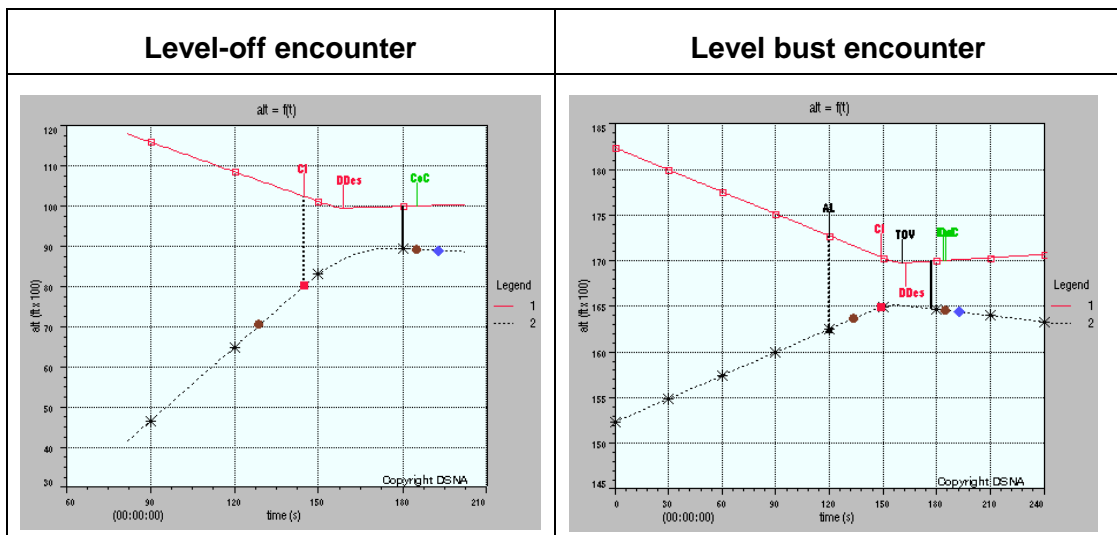

**Figure 10: Illustrations of the effect of the CFL option on STCA behaviour**

### 3.3.4. Areas of improvements

- 3.3.4.1. The environment in which the STCA is being operated is of particular importance when evaluating STCA performances. The study highlighted some areas in which the modelling of this environment could be improved as follows.
  - 3.3.4.2. To allow for the determination of representative alert rates, it would first be required that the encounter model be focused on all situations where an alert is probable. These situations range from serious encounters (as captured by the safety encounter model) to encounters in which the separation is maintained thanks to last-minute manoeuvres (as some encounters captured by the ATM encounter model).
  - 3.3.4.3. To address the issue of alert classification, it would be of interest that the encounter severity be determined without taking into account the effect of a controller intervention likely to result from the issuance of an alert.
  - 3.3.4.4. These elements are in favour of the development of an ATC incident-based encounter model (based on real incidents that occurred in Europe) that would not take into account the effect of late controller interventions observed in the real encounters used to build the model.
  - 3.3.4.5. It might also be of interest to model the possible controller reaction in response to an STCA alert apart from the encounter model itself. Such modelling (as done for the pilot response to RAs when evaluating ACAS performances) would allow the evaluation of the effectiveness of STCA through its ability to alert the controller with sufficient warning time to maintain, or restore, separation between the aircraft.
  - 3.3.4.6. Finally, to allow a precise evaluation of the impact of the CFL option on the safety benefits of STCA, it would be required to refine the modelling of the CFL data using operational statistics on the frequency of incorrect or neglected input of CFL by the controller.



### 3.4. Level of STCA performance evaluation

#### 3.4.1. Relevance of the alert statistics

- 3.4.1.1. The alert statistics computed during this feasibility study should be taken with care for two main reasons. First, the figures derived from the safety encounter model only apply to encounter situations where aircraft are in a collision course, which may bias the corresponding statistics. Second, the number of relevant encounters with the ATM encounter model was too small to derive representative statistics.
- 3.4.1.2. Despite these limitations, it was possible to observe some general trends with regard to the influence the STCA configuration (i.e. with or without the use of CFL) and parameters (i.e. high or low values) on the alert occurrences, their warning time and the possible interaction with ACAS.
- 3.4.1.3. First the simulations conducted with the safety encounter model have shown that, both in TMA and en-route airspace, the high values of STCA parameters are likely to trigger much more (i.e. about 20% more) alerts than the low parameter values as shown in Figure 6. It was also observed that the likelihood of alerts without actual separation infringement increased when using the high values of STCA parameters (i.e. from 30% to 47%).
- 3.4.1.4. All serious encounters did trigger an alert, except a small proportion of when using the low values of STCA parameters (i.e. about one in every 1000 serious encounters in TMA and 6% of the serious encounters in en-route without any alert). These missed alerts were observed in situations where the intervals of lateral and vertical separation violation determined by the 'Linear Prediction Filter' were very close, but without any overlap due to the use of reduced STCA parameters.
- 3.4.1.5. Although the likelihood of alerts with the ATM encounter model was limited, the simulations have shown that, both in TMA and en-route, the use of the CFL option can reduce significantly the number of alerts (see Figure 8). Further, as shown in Figure 11, this reduction essentially applied to unnecessary alerts that occurred within encounters without any separation infringement, typically 1,000 ft level-off encounters.

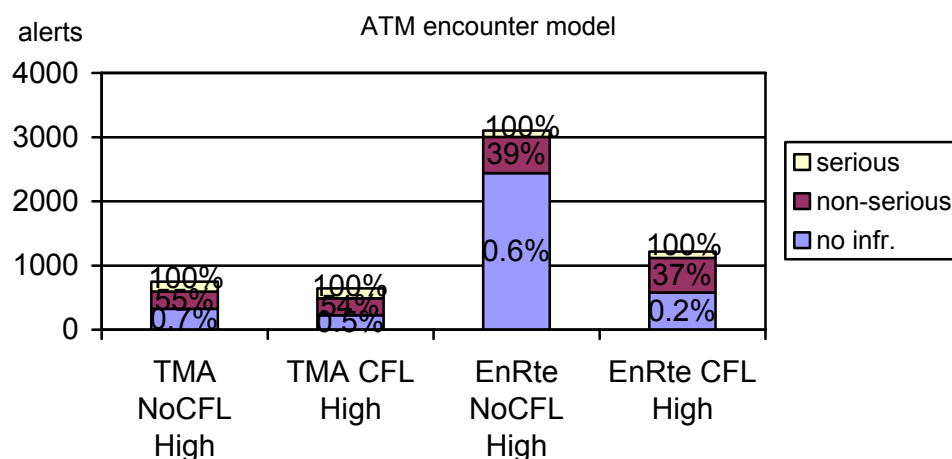

Figure 11: Alert severity breakdown with the ATM encounter model

3.4.1.6. These simulation results show the potential of the encounter-model approach for evaluating STCA performances even though there exists some bias in the alert statistics computed during the study due to the various limitations already discussed.

### 3.4.2. Relevance of the warning time metrics

3.4.2.1. EUROCONTROL defines the warning time as “the amount of time between the first indication of an alert to the controller and the predicted violation of applicable separation minima” [STCA1].

3.4.2.2. This definition raises the issue of which “separation minima” shall be used when determining the warning time of an STCA alert. The study investigated different warning time metrics that use either the separation minima applicable in the airspace by the Air Traffic Control services, or the separation thresholds used by the STCA system itself.

3.4.2.3. Further, this definition does not take into account the possible effect of STCA, i.e. an aircraft manoeuvre following the controller intervention in response to an alert. As a consequence, it is not possible to directly determine this theoretical warning time in encounters that may include manoeuvres that affect the aircraft separation at closest approach<sup>8</sup>.

3.4.2.4. To investigate this issue, the warning time metrics evaluated within the study use two different methods of calculation using either the actual trajectories eventually observed in the encounters, or predicted trajectories (using the prediction mechanism of the STCA model).

3.4.2.5. A consolidated metric was also proposed [WP06], which defines the warning time as the minimum between the ‘actual warning time’<sup>9</sup> observed in the encounter and the ‘predicted warning time’<sup>10</sup> estimated at the time of the alert (referred hereafter to as ‘top STCA’):

Minimum warning time = MIN (“actual warning time”, “predicted warning time”)

3.4.2.6. This definition was considered a conservative definition since it tends to minimize the warning time associated with an alert, in particular in encounters with a late manoeuvre that delays the time of actual infringement of the separation minima.

3.4.2.7. To assess the relevance of this definition, six other and more elementary warning time metrics were evaluated during the study as follows:

- the warning time before predicted ‘Time of Separation Infringement’<sup>11</sup> calculated at the time of the alert:

WT before predicted TSI = “predicted TSI at top STCA” – “top STCA”

---

<sup>8</sup> This issue is not linked to the encounter model approach. It also exists in real-life when assessing actual ATC incidents in which the STCA alerts the controller who issues a late instruction to maintain (or restore) aircraft separation.

<sup>9</sup> I.e. the warning time before the actual ‘Time of Separation Infringement’ (TSI) observed in the encounter, if any.

<sup>10</sup> I.e. the warning time before predicted TSI calculated at the time of the alert.

<sup>11</sup> The predicted TSI always exists assuming the separation thresholds used by the STCA are lower than the ATC separation minima.

- the warning time before the actual ‘Time of Separation Infringement’ (TSI) observed in the encounter, if any<sup>12</sup>:

$$\text{WT before actual TSI} = \text{“actual TSI”} - \text{“top STCA”}$$

- the warning time before predicted ‘Time of Separation Violation’ calculated at the time of the alert:

$$\text{WT before predicted TOV} = \text{“predicted TSI at top STCA”} - \text{“top STCA”}$$

- the warning time before the actual ‘Time of Violation’ (TOV) calculated by the STCA<sup>13</sup> based on the separation thresholds of the ‘Linear prediction Filter’:

$$\text{WT before actual TOV} = \text{“actual TOV”} - \text{“top STCA”}$$

- the predicted warning time before closest approach, i.e. the warning time before the predicted CPP:

$$\text{WT before predicted CPP} = \text{“predicted time of CPP at top STCA”} - \text{“top STCA”}$$

- the actual warning time before the closest approach, i.e. the warning time before the actual CPP:

$$\text{WT before actual CPP} = \text{“actual time of CPP”} - \text{“top STCA”}$$

3.4.2.8. These different metrics provided different, yet consistent, measures of the warning time provided by the STCA alerts. As an illustration, Figure 12 shows the warning time distributions observed on the safety encounters in en-route (when using high values of STCA parameters and the CFL option).

Note: For comparison purposes, the figure also shows the ‘LinearPrediction-WarningTime’ threshold whose value was 90 seconds in the considered scenario.

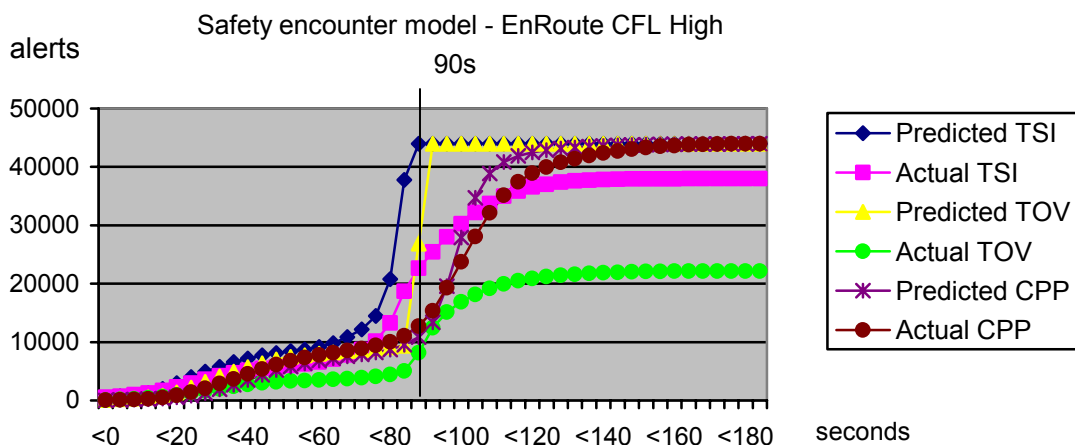

**Figure 12: Warning time distributions with the safety encounter model**

3.4.2.9. For a given method of calculation, similar trends were observed between the warning times determined using the ‘Time of Separation Infringement’ or the ‘Time of Violation’.

<sup>12</sup> This warning time metric is not always measurable since the actual TSI that does not exist in encounters including a manoeuvre that ensures separation.

<sup>13</sup> Unlike the actual TSI, the actual TOV always exists as far as an alert is being triggered.

- 3.4.2.10. For a majority of alerts, the warning times determined using the ‘predicted TSI’ (or the ‘predicted TOV’) were close to the ‘LinearPredictionWarningTime’ threshold, but there existed a significant proportion of alerts (i.e. more than 15%) for which the predicted warning time was less than half this threshold. The corresponding encounters generally consisted of imminent conflict situations in which an alert was triggered as soon as the manoeuvre was detected.
- 3.4.2.11. The warning times determined using the ‘actual TSI’ (or the ‘actual TOV’) were observed greater than the ‘LinearPredictionWarningTime’ threshold for a significant proportion of alerts (i.e. about 40% when using the ‘actual TSI’ and up to 63% when using the ‘actual TOV’). This resulted from encounters including a manoeuvre that increased the aircraft separation at closest approach, as well as the warning time measured in the actual encounters.
- 3.4.2.12. As an illustration, Figure 13 presents the warning time distributions observed on the safety encounters depending on the considered airspace (i.e. TMA or en-route) and the scenario of STCA configuration and parameters.

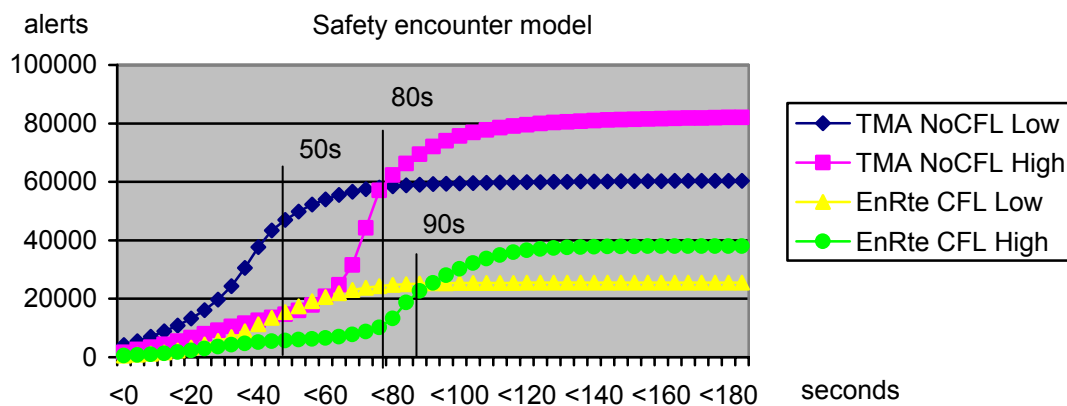

**Figure 13: Distribution of the actual warning time with the safety encounter model**

- 3.4.2.13. The simulation results also confirmed that the warning time determined using the ‘predicted (or actual) TOV’, and even more that determined using the ‘predicted (or actual) CPP’, tend to overestimate the look-head time left to the controller to maintain, or restore, the separation between the aircraft. These results are related on one hand, to the relationship that exists between TOV and the separation thresholds used by the STCA (assumed lower than the separation minima applicable by ATC), and on the other hand, to the definition of CPP itself, which always occurs after the time of violation of any separation minima (as far as these minima are infringed).
- 3.4.2.14. In conclusion, the ‘warning time before the predicted TSI at the time of the alert’ proved to be a conservative metric for evaluating the time left to the controller following an STCA alert (even in encounters with late manoeuvres that impact the aircraft separation at closest approach). The determination of the ‘warning time before the actual TSI’ may constitute an alternative warning time definition when using an encounter model that does not include manoeuvres resulting from a late controller intervention.

### 3.4.3. Relevance of the STCA / ACAS interaction metrics

- 3.4.3.1. As a reminder, ACAS provides two levels of alert to the pilot, viz. Traffic Advisories (TAs) and vertical Resolution Advisories (RAs). The TAs aim at helping the pilot in the visual search for the ‘intruder’ aircraft, whereas as the RAs are indications to the pilot of manoeuvres intended to provide separation from all ‘threats’; or manoeuvre restrictions intended to maintain existing separation.
- 3.4.3.2. One would expect the STCA alerts to generally occur in advance of RAs to limit the risk of interference between ATC and ACAS. For TAs, this expectation is not so strong since the pilots are neither expected to manoeuvre, nor to contact ATC, following the issuance of TAs. However, the lack of STCA alert in encounters triggering TAs onboard the aircraft would require some attention.
- 3.4.3.3. Within the scope of the I-AM-SAFE study, the possible interaction between STCA and ACAS was investigated using basic metrics related to the occurrences and timing of the alerts issued by the two safety nets. Further, the ‘safety encounter model’ and the ‘ATM encounter model’ supported the investigation of different aspects of the STCA and ACAS interaction issue.
- 3.4.3.4. On one hand, the ‘safety encounter model’ could be used to assess the efficacy of STCA in risk bearing encounters and the level of interaction with ACAS RAs. It should however be kept in mind that, being focused on situations where aircraft are on a collision course, the ‘safety encounter model’ exaggerated the interaction that exists between STCA and ACAS in current ATM operations.
- 3.4.3.5. As shown in Figure 14, only few proportions of the safety encounters with an alert in en-route corresponded to situations where the RAs were triggered after the STCA alert (i.e. between 1% and 2% depending on the scenario) or without any STCA alert (i.e. between 6% and 10% depending on the scenario). Most of these situations (but not all) could be explained by the use of the CFL by the STCA in 1,000ft level-off encounters.

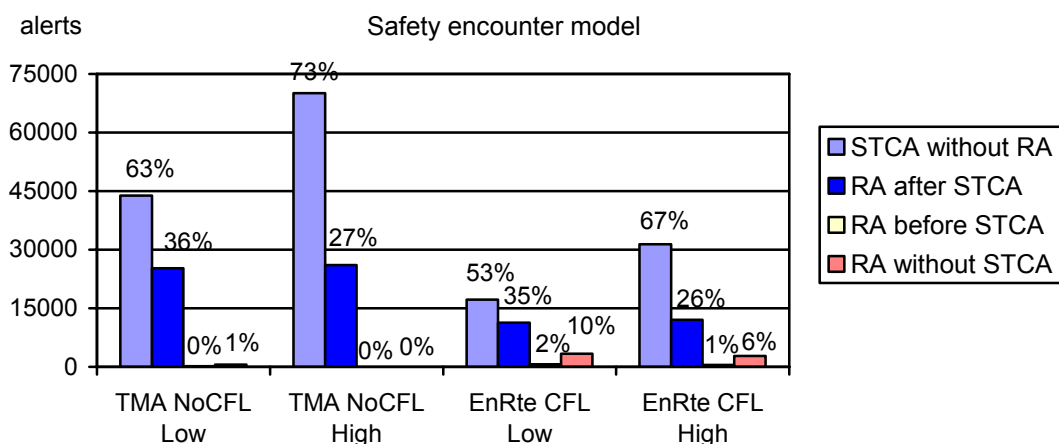

Figure 14: Timing of STCA and RA alerts with the safety encounter model

- 3.4.3.6. On another hand, the ‘ATM encounter model’ could be used to assess the compatibility between STCA and ACAS in day-to-day operations. As shown in Figure 15, although the number of alerts was not very high, it provided more realistic ratios of STCA and ACAS alerts (when using high values of STCA parameters).

3.4.3.7. It was notably observed that many STCA alerts were triggered in encounters with some horizontal miss distance that prevented the issuance of ACAS RAs (i.e. only about 20% of STCA alerts triggering an RA in TMA and between 2% and 4% in en-route depending on the scenario). It was also observed that, despite the use of STCA warning time thresholds greater than the alert time thresholds for TAs, the likelihood of TAs was of the same order of magnitude as the likelihood of STCA alerts (except when using the CFL option in en-route).

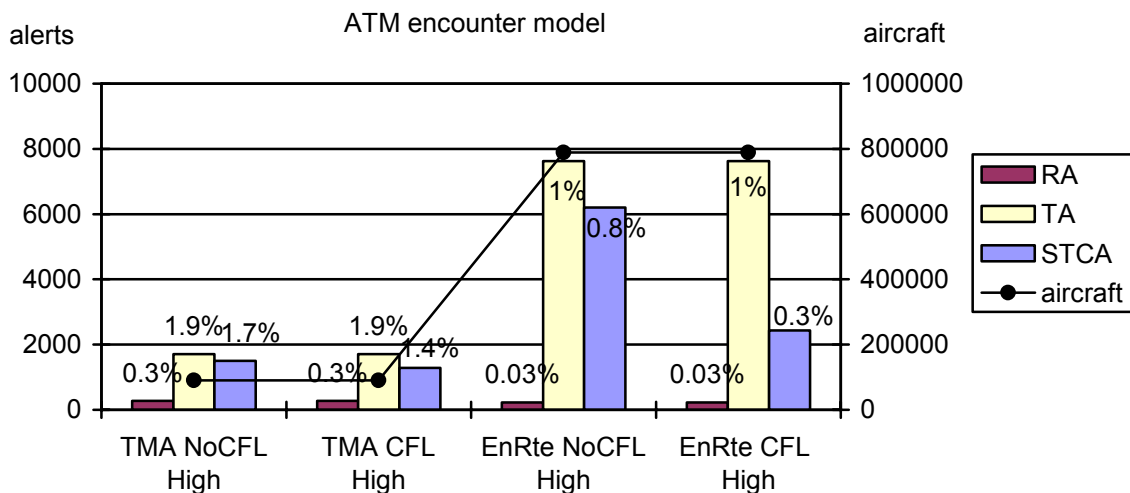

Figure 15: STCA and ACAS alert occurrences with the ATM encounter model

3.4.3.8. The insight made on the relative timing between STCA and the ACAS alerts also highlighted that many TAs were simulated in encounters that did not trigger any STCA alert. This phenomenon increased when the CFL option was used by the STCA simulations. Figure 16 is an example of such an encounter triggering TAs without any STCA alert (despite the use of high values of configuration parameters).

Note: The figure presents the trajectories of the aircraft versus time, as well as the simulated ACAS intruder status onboard the first aircraft (in red) indicated on the trajectory of the intruder aircraft (in black).

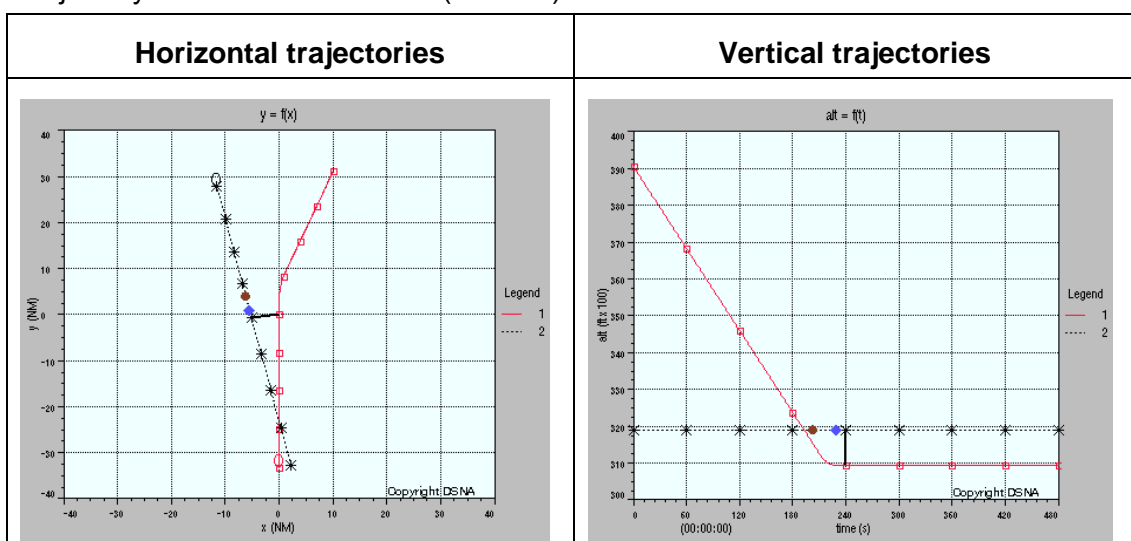

Figure 16: Illustration of a TA encounter without STCA alert – High values of STCA parameters

3.4.3.9. This encounter illustrates the behaviour of the TA logic, which uses the closure rate to estimate the time of closest approach regardless of the predicted horizontal miss distance. As far as aircraft are sufficiently close in altitude and even if they are vertically diverging, the TA is being issued. This behaviour is quite distinct from that of the STCA, which is looking for an overlap between the intervals of horizontal and vertical separation. In such an encounter in which the controller applies a composite separation, this overlap never occurs and no alert is being triggered.

#### **3.4.4. Areas of improvements**

3.4.4.1. The basic performance metrics evaluated during the study provided some insight on the likelihood and relevance of STCA alerts and their level of interaction with ACAS alerts. However, the simulation results have to be taken with care due to the limitations of the simulated environment (see section 3.3.4 for further details).

3.4.4.2. The study also pointed out the need for more sophisticated metrics that would allow for the evaluation of STCA performances while taking into account, in an appropriate manner, the possible controller reaction in response to the alerts (e.g. delay reaction time to determine and communicate then avoiding action to the pilot) and possibly the ability of this controller reaction to prevent the issuance of ACAS RAs.

3.4.4.3. Further, the encounter and alert classification would need to be improved to take into account not only the aircraft separation at closest approach, but also the relative profile of the aircraft (e.g. convergent or divergent trajectories) and possibly the encounter geometry (e.g. level-off, altitude bust, etc).

## **4. Conclusions and recommendations**

### **4.1. General**

- 4.1.1. The feasibility assessment performed in the I-AM-SAFE project confirms that the STCA standardisation process can benefit from the experience gained through the development of the ICAO performance SARPs for ACAS and from the methodology and tools that supported previous ACAS-related studies in Europe.
- 4.1.2. Both systems raise similar issues to a certain extent (with additional complexity for STCA compared to ACAS due to the wider variety of circumstances and the longer time frame in which STCA is relevant). Further, the possible interaction between the two safety nets is an area of concern that needs particular attention.

### **4.2. Main study outcomes**

- 4.2.1. The study demonstrated the operational realism of the reference STCA model implemented during the project despite its simplicity. It also pointed out the potential interest of implementing other optional features described in the EUROCONTROL guidance material for STCA. Further, to improve the realism of the input surveillance data, some consideration might be given to the development of a surveillance model that would be representative of current surveillance performances in Europe.
- 4.2.2. The encounter model-based methodology has demonstrated to be applicable and useful to evaluate the performance of STCA, and the possible interaction issues with ACAS, although some adaptations would be required to specifically address STCA.
- 4.2.3. The 'safety encounter model' was found more appropriate than the 'ATM encounter model' to assess the efficacy of STCA, in particular with the provision of reliable warning time statistics. However, due to its focus on collision risk bearing encounters, it exaggerated the alert rates, and the interaction that exists between STCA and ACAS, in current ATM operations. The 'ATM encounter model' proved to be useful for evaluating the compatibility of STCA with day-to-day ATM operations, especially for assessing alert rates.
- 4.2.4. To allow at the same time for the evaluation of STCA effectiveness and the determination of representative alert rates, these results are in favour of the development of an ATC incident-based encounter model (derived from real incidents that occurred in Europe) that would encompass the interest of both the safety and ATM encounter models without their limitations. This encounter model would need to capture the properties of both safety-related encounters and day-to-day encounters likely to generate STCA alerts. Both these encounter sets are necessary for a full assessment of STCA performance.
- 4.2.5. Although quite simple, the STCA performance metrics evaluated during the study (using the two encounter models available at this stage) have shown the potential of the encounter model-based methodology for evaluating STCA performances and the possible interaction issues with ACAS. In particular, the study highlighted the influence of the encounter characteristics (i.e. risk bearing situations or day-to-day conflicts in TMA or en-route), the STCA configuration (i.e. with or without the use of CFL) and parameters (i.e. high or low values), as well as the quality of the data provided to STCA, on the likelihood and relevance of the alerts.



- 4.2.6. The determination of the warning time provided by an alert has been demonstrated to be essential when evaluating the effectiveness of STCA. The warning time before the ‘predicted time of separation infringement (at the time of the alert)’ proved to be a conservative metric for evaluating the time left to the controller to intervene even in encounters with late manoeuvres. The warning time before the ‘actual time of separation infringement’ may constitute an alternative warning time metric less sensitive to the quality of the trajectory data, but more sensitive to late manoeuvres that affect the separation between the aircraft.
- 4.2.7. The study also raised the issue of the appropriate determination of the encounter severity, the classification of the alerts and the warning time evaluations in encounters with manoeuvres resulting from a late controller intervention. To address this issue, it would be of interest to model the controller intervention in response to an STCA alert apart from the encounter model itself. This would also allow evaluating the ability of STCA to alert the controller with sufficient warning time to maintain, or restore, separation between the aircraft.
- 4.2.8. In summary, the results of this feasibility study are very promising and areas of improvements have been identified to better address the issues related to STCA.

### 4.3. Possible future work

- 4.3.1. Taking into account the main study findings, the following figure sketches out a more sophisticated framework that would enable the evaluation of STCA performance and safety benefits while taking into account the effect of ACAS operations.

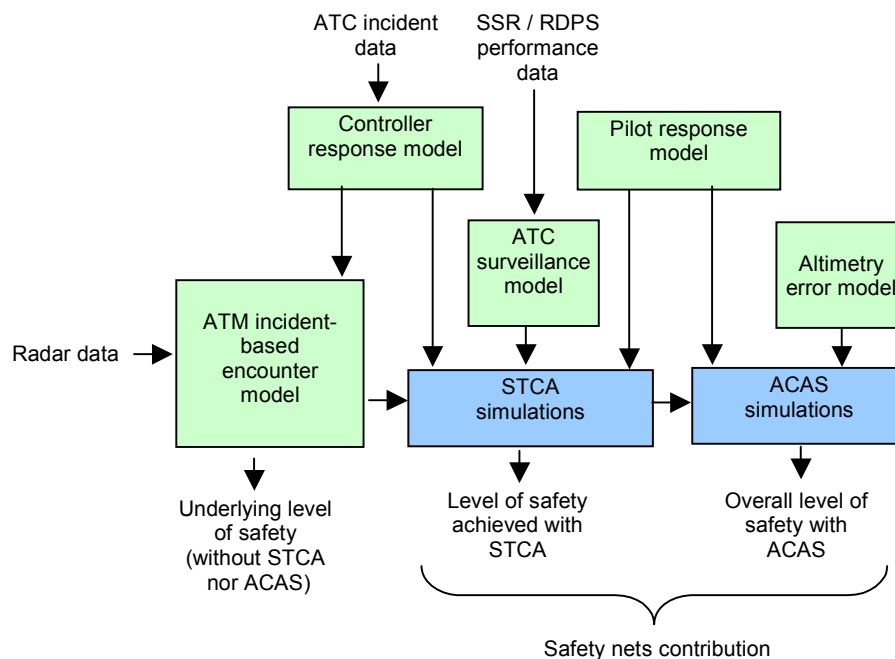

**Figure 17: Possible framework for the development of STCA performance requirements**

- 4.3.2. This framework builds upon the encounter model-based methodology and the various areas of improvement identified during the study. In a nutshell, the approach would consist of simulating the behaviour of STCA, the subsequent controller intervention, as well as the pilot’s reaction to this intervention and possibly that of ACAS. This would enable the determination of the contribution of each safety net, separately, and also in combination.

4.3.3. This framework needs to be complemented with agreed and consolidated performance metrics that will support the evaluation of STCA effectiveness and the establishment of minimum performance requirements. Finally, objective criteria for encounter and alert classification will have to be established.

#### **4.4. Recommendations**

4.4.1. For maximum safety benefits, the standardisation of STCA should be supported by a comprehensive evaluation of the effectiveness of STCA and its possible interaction with ACAS.

4.4.2. Analysis of real ATC incidents should be conducted, as far as possible using different STCA implementations in Europe, to build up the required understanding of the current situation in terms of:

- a) the typical sequences of events during ATC incidents in which STCA and/or ACAS play a role,
- b) the environment and causal factors influencing more the effectiveness of STCA, and the possible interaction with ACAS, and
- c) the behaviour of controllers and pilots in response to the alerts generated by the two safety nets.

4.4.3. The development of quantified performance requirements for STCA should be supported by a methodological framework as the one evaluated in the I-AM-SAFE project with some adaptations to specifically address STCA including:

- a) the modelling of all encounter situations, and only those, where STCA and/or ACAS are likely to play a role,
- b) the separate modelling of controller intervention in response to STCA and subsequent pilot's reaction,
- c) a more in-depth modelling of STCA behaviour, including the effect of optional STCA features and the quality of the input surveillance data.

4.4.4. The development of Standard and Recommended Practices for STCA should be supported by complementary studies addressing the human factors and safety issues related to the joint operation of STCA and ACAS, so as to remove the theoretical barrier that currently exists between the two safety nets.

4.4.5. The standardisation process should complement other efforts to demonstrate the safety benefits of any STCA implementation. In particular, it does not relieve ANSPs of an optimisation and performance evaluation process that takes into account the local ATC characteristics (in terms of surveillance, traffic and working methods).

## 5. References

### 5.1. Reference documents

- [ACAS] ICAO, Annex 10, Volume IV, Surveillance Radar and Collision Avoidance Systems, 3<sup>rd</sup> edition, July 2002
- [ACA1a] ACASA Project – Final report on studies on the safety of ACAS in Europe – EUROCONTROL ACAS Programme – ACASA/WP1.8/210D, Version 1.3, March 2002
- [ACA1b] ACASA Project – European Encounter Model: Part 1/2 – EUROCONTROL ACAS Programme – Specifications, ACASA/WP1.1/186, Version 2.1, December 2001
- [ASARP] Final report on the safety of ACAS II in the European RVSM environment – EUROCONTROL – 11 May 2006, Edition Number 1.1
- [IAPA] IAPA Project Final Report – Synthesis and guidelines – EUROCONTROL –. 28 October 2005, Edition Number 1.2
- [ORD] Operational Requirements Document for EATCHIP Phase III ATM Added Functions - Volume 2: Safety Nets – EUROCONTROL – 25 January 1999, Edition Number 2.0
- [OSCAR] DSNA – OSCAR test-bench, User's Manual, Version 2.0, October 1996.
- [SNETS] Survey of Practices in Safety nets, Summary Report – EUROCONTROL –. 14 February 2005, Edition Number 1.0
- [STCA1] EUROCONTROL Specification for Short Term Conflict Alert – Edition Number 0.6, 14 December 2006
- [STCA2] EUROCONTROL Guidance Material for Short Term Conflict Alert – Edition Number 1.0, 14 December 2006
- [TCAS] RTCA Inc. – Minimum Operational Performance Standards for Traffic alert and Collision Avoidance System II airborne equipment – DO-185A, 1997

### 5.2. I-AM-SAFE working papers

- [WP01] Project Management Plan – Version 1.0 – 03-07-06 – Deliverable (D1)
- [WP02] STCA modelling (slides) – Version 1.0 – 29-06-06 – Working Document
- [WP03] ATM & Safety encounter models (slides) – Version 1.0 – 29-06-06 – Working Document
- [WP04] Scenarios and metrics (slides) – Version 1.0 – 29-06-06 – Working Document
- [WP05] Notes on the Kick-Off Meeting – Version 1.0 – 03-07-06 – Working Document
- [WP06] Warning time definition – Version 1.1 – 06-10-06 – Working Document
- [WP07] Statistics on STCA alerts – Version 1.1 – 06-10-06 – Working Document

- [WP08] Verification of the STCA simplified model implementation – Version 1.1 – 02-10-06 – Working Document
- [WP09] Generic STCA: Specification of STCA model outputs – Version 1.1 – 02-10-06 – Working Document
- [WP10] Operational validation of the STCA simplified model implementation – Version 1.1 – 15-02-07– Working Document
- [WP11] Notes on the 2nd Progress Meeting – Version 1.0 – 29-09-06 – Working Document
- [WP12] Reference STCA model design – Version 1.2 – 15-12-06 – Working Document
- [WP13] I-AM-SAFE feasibility study presentation at SPIN-TF/10 (slides) – Version 1.0 – 21-11-06 – Working Document
- [WP14] Overview of STCA statistics (slides) – Version 1.0 – 20-11-06 – Working Document
- [WP15] I-AM-SAFE feasibility study report – Version 1.1 – 21-03-07 – Deliverable (D2)
- [WP16] Notes on the 3rd Progress Meeting – Version 1.0 – 24-11-06 – Working Document
- [WP17] Simulation results on the safety & ATM encounter models – Version 1.1 – 15-02-07 – Working Document
- [WP18] Replay Material – Version 1.1 – 23-03-2007 – Deliverable (D3a)
- [WP19] I-AM-SAFE feasibility study outcomes (slides) – Version 1.0 – 09-03-2007 – Deliverable (D3b)
- [WP20] Notes on the 4th Progress Meeting – Version 1.0 – 06-02-07 – Working Document

## **Appendix A. The Implications on ACAS Performances due to ASAS implementation Project**

### **A.1. Scope and objectives**

- A.2. The operational use of the 'Airborne Separation Assistance System' (ASAS) is seen as a promising option to improve the ATM system through a greater involvement of the flight crew in the separation provision.
- A.3. The IAPA ('Implications on ACAS Performances due to ASAS implementation') project addressed the ACAS / ASAS interaction issue, analysed its potential operational and safety implications and provided guidelines for the future development of ASAS applications in Europe.
- A.4. The project came within the scope of the EUROCONTROL Mode S and ACAS Programme. The project was conducted in three main phases:
- Phase I (November 2002 – October 2003) defined the scope and framework of the ACAS / ASAS interaction study;
  - Phase II (November 2003 – December 2004) consisted of the performance of the required simulations for an in-depth operational analysis of the interaction between ACAS and ASAS. It also assessed the impact of ASAS operations on the safety benefit provided by ACAS; and
  - Phase III (January 2005 – November 2005) consolidated the results of the previous phases and drew the project conclusions and recommendations.
- A.5. The project represented a total effort of more than 11 man-years. The technical work was conducted by a consortium of four organisations (DSNA, EEC, QinetiQ and Sofréavia) and the project was managed by the ATM division of Sofréavia.

### **A.6. Phase I: Scope and framework**

- A.7. The first Phase consisted of selecting and defining an ASAS application with the potential for studying a maximum of significant and realistic ACAS / ASAS interaction issues. The selection was supported by a preliminary analysis of the ACAS / ASAS interaction issue for a set of ASAS applications proposed for early implementation in Europe.
- A.8. Phase I also established the framework required for an in-depth investigation of the ACAS / ASAS interaction issue. This framework supported the various simulations conducted in Phase II and included:
- a common simulation framework defining three different ASAS scenarios for the use of the selected ASAS application, and defining a list of ACAS / ASAS interaction indicators;
  - a simplified model of the selected ASAS application, i.e. the ASAS lateral crossing procedure, simulating its nominal effect on the aircraft trajectories assuming perfect ASAS performance; and
  - an ATM encounter model describing conflict situations observed in current ATM operations in core Europe.

## **A.9. Phase II: Operational and safety analyses**

- A.10. Phase II consisted of a comprehensive investigation of the operational and safety issues potentially raised by the introduction of ASAS in the European airspace. This investigation was focused on the ASAS lateral crossing procedure using realistic assumptions yet demanding in terms of potential interaction with ACAS.
- A.11. The operational analysis of the potential ACAS / ASAS interaction issues was supported by a full set of simulations using different sources of data including:
- an ASAS encounter model, which was derived from the ATM encounter model assuming typical use of the selected ASAS application;
  - modified European radar data;
  - CFMU flight plan simulation data; and
  - data extracted from real-time simulation data.
- A.12. The different sources of data were used to compensate for any individual limitations related to any one of them and to ensure that all relevant issues were identified. Further, the use of the common simulation framework set-up during Phase I allowed the cross-validation of ACAS / ASAS interaction trends identified using each source of data.
- A.13. The safety analysis consisted of an initial evaluation of the level of safety that can be expected from the operation of ACAS when aircraft are engaged in ASAS procedures. This level of safety was assessed both qualitatively in terms of consequences and severity of hazards, and quantitatively in terms of the reduced risks of collision.

## **A.14. Phase III: Operational and safety analyses**

- A.15. Phase III concluded the project by consolidating the work performed during Phase I and Phase II, and delivering guidelines for the development of future ASAS applications.
- A.16. The project was a substantial European contribution to the understanding of the potential interaction between ACAS and ASAS procedures. It notably demonstrated that:
- ACAS remains effective as the last resort safety net and the demonstrated safety benefits underline the need to operate ACAS during ASAS operations;
  - The ACAS constraints must be taken into account when developing ASAS procedures envisaged for implementation; and
  - The existing ACAS system may need to evolve to improve compatibility with ASAS applications envisaged for implementation.
- A.17. The project also provided evidence that a comprehensive and robust methodological framework will be required to support such future investigation of the ACAS / ASAS interaction issue. In this respect, the complete work programme carried out within IAPA is a substantial body of work on which further work should build on.

## **Appendix B. The ACAS Safety Analysis post-RVSM Project**

### **B.1. Scope and objectives**

B.2. The ACAS Safety Analysis post-RVSM Project assessed whether the ACAS safety benefits anticipated prior to the introduction of RVSM (Reduced Vertical Separation Minimum) operations are indeed achieved. To do so, the study replaced the operational assumptions made prior to RVSM introduction by actual RVSM operational data.

B.3. The project built upon the ACAS safety studies formed in support to the mandates for the carriage of ACAS II in Europe during the years 2000, which were performed based on prediction of the RVSM operational environment.

B.4. The project came within the scope of the EUROCONTROL Mode S and ACAS Programme. It spanned a one-year-and-a-half schedule between October 2004 and May 2006. The technical work was conducted by a consortium of three organisations (DSNA, QinetiQ and Sofréavia), the ATM division of Sofréavia being in charge of the project management.

### **B.5. European RVSM environment**

B.6. To get a comprehensive understanding of both ACAS and RVSM operations, up-to-date operational data were collected, and analysed. These data included:

- i)* European radar data including the busiest sectors of the RVSM airspace,
- ii)* onboard data (from four European airlines for years 2001, 2002 and 2004) associated with actual ACAS events, and
- iii)* RVSM monitoring data (from three Height Monitoring Units in the year 2004) related to altimetry performance of aircraft.

B.7. This enabled the building of a set of models, then used to determine the safety of ACAS in the European RVSM airspace. These models consist of a European safety encounter model that reflects the possible effect of RVSM operations, a model of typical pilot reaction in response to RAs and a model of altimetry errors applicable in the RVSM airspace.

### **B.8. Evaluation of the safety benefits of ACAS in RVSM**

B.9. The focus was on the evaluation of the safety benefits (in terms of reduced risk of mid-air collision) afforded by ACAS in the European RVSM airspace, and the identification of the main factors that influence this risk reduction.

B.10. ACAS was demonstrated to reduce the risk of mid-air collision by a factor of about sixty (*viz.* a risk ratio of about 1.7%). The level of protection provided by ACAS has proven to be robust to the altimetry errors actually observed in RVSM airspace, as well as to other hazards that may affect ACAS operations. Further, the risk reduction was estimated to be ten times greater at the RVSM altitudes than in the airspace as a whole.

- B.11. The key factor that influences the risk reduction delivered by ACAS in RVSM airspace was demonstrated to be the pilot response rate to the RAs. It was notably established that if all pilots would follow the RAs instead of sometimes giving preference to late controller instructions, the level of protection delivered by ACAS could be further increased by about a factor of two.
- B.12. Taking into account the underlying risk in the absence of ACAS (estimated to be of about  $1.7 \times 10^{-8}$  mid-air collision per flight-hour), the risk ultimately achieved with ACAS in the European RVSM airspace was estimated to represent about three mid-air collisions every  $10^{10}$  flight-hours.
- B.13. It was also established that about one third of the risk results from an inadequate use of the ACAS system, i.e. when one pilot manoeuvres contrary to the RA. This risk could be further reduced by modifying the ACAS collision avoidance logic as described in a Change Proposal (CP112E) currently being progressed.
- B.14. Investigation of the multiple aircraft encounters**
- B.15. The study not only dealt with situations involving two aircraft, but also addressed the issue of a third party aircraft flying in close proximity ('multiple aircraft encounters').
- B.16. In those multiple aircraft encounters that might occur in RVSM airspace, ACAS has proven to issue stable and effective RAs, typically RAs that require own aircraft to level-off in-between the two simultaneous threats.
- B.17. From a safety perspective, the risk of mid-air collision in the case of RVSM multiple aircraft encounters was estimated to be reduced by a factor of about fifteen thanks to ACAS (i.e. a risk ratio of about 6%).
- B.18. Conclusions and recommendations**
- B.19. The study concluded that ACAS, as actually observed to be operated, provides substantial safety benefits in the European RVSM airspace. These benefits are also significant in the case of RVSM multiple aircraft encounters (even though the risk reduction is four times less significant in such circumstances). Further, the study provided evidence that the induced ACAS risk is small in the context of the TLS for RVSM.
- B.20. For the safety benefits of ACAS to be maximised, it was recommended that all adhere to the standardised ACAS operational procedures, and that ACAS best practice is always applied. To reduce the residual risk with ACAS in the European RVSM airspace, as in the whole airspace, it was also recommended to proceed with the implementation of Change Proposal CP112E to the ACAS collision avoidance logic.



## Appendix C. Overview of the ATM and safety encounter models

### C.1. General

C.2. The 'ATM encounter model' and the 'safety encounter model' are mathematical models which define the distributions and interdependencies of the parameters characterising encounters likely to occur in ATM operations.

C.3. The two models include a set of tables defining the properties of each of the encounter parameters. These define the characteristics of individual trajectories and their relationship to one another when combined into an encounter.

C.4. The probabilities of each of the encounter parameters have been determined by analysing very many encounters extracted from European radar data and counting the number of instances of an encounter with given properties.

### C.5. Main features

C.6. The altitude at which each encounter occurs is a dominant feature of the two encounter models. The airspace is divided into a number of **altitude layers** whose boundaries have been chosen to reflect the differing characteristics of the encounters at different altitudes.

C.7. Most of the encounters (90%) whose properties are captured by the 'ATM encounter model' occur in en-route airspace (i.e. above FL135), whereas about two third of the encounters taken into account by the 'safety encounter model', occur in TMA airspace (i.e. below FL135).

C.8. In the two encounter models, the realism of individual trajectories is ensured by the use of **eight aircraft performance** classes (based on engine type and airframe size) intended to reproduce the typical performance limitations of groupings of aircraft.

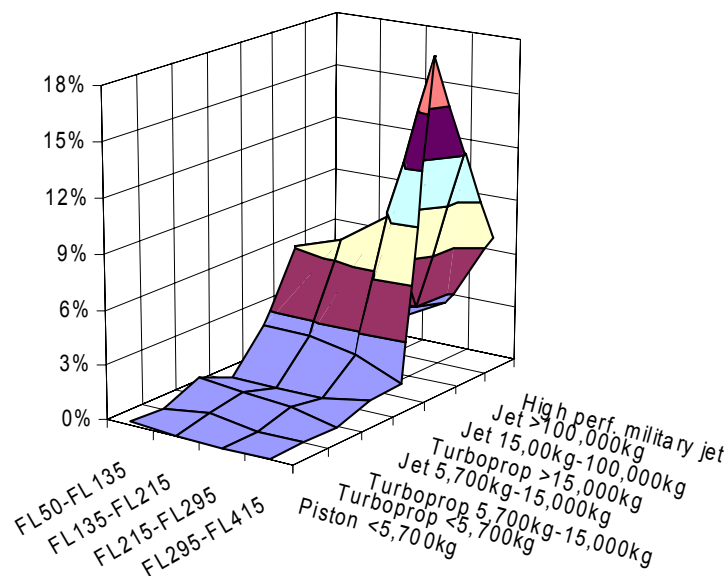

Figure 18: Aircraft types per altitude layer in the ATM encounter model

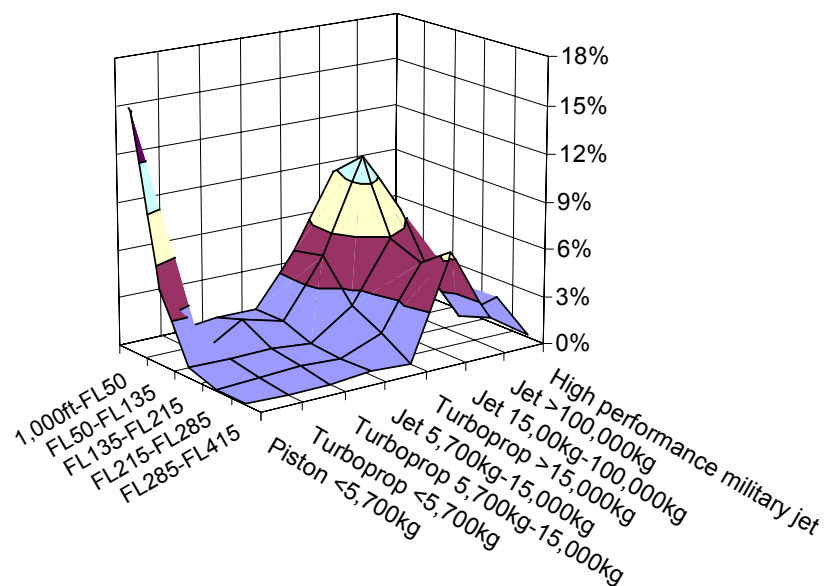

Figure 19: Aircraft types per altitude layer in the safety encounter model

C.9. Another essential feature of both encounter models is the **separation at closest approach** defined by a horizontal component ('Horizontal Miss Distance') and a vertical component ('Vertical Miss Distance'). However, both encounter models use a different definition of closest approach:

- The 'safety encounter model' uses the 'Closest Point of Approach' (CPA), i.e.; the local minimum in the physical distance between two aircraft.
- The 'ATM encounter model' uses the 'Closest Point of Propinquity', i.e. the local minimum in the 'propinquity' distance between two aircraft. This measure scales the horizontal and vertical distances (h and v) between the aircraft according to the respective separation minima (H and V).

$$\rho = \sqrt{(h/H)^2 + (v/V)^2}$$

C.10. The separation at CPA is what matters most when assessing the risk of mid-air collision, whereas the separation at CPP is most appropriate for assessing the risk of separation infringement<sup>14</sup>. It should be noted that which of the CPA or CPP occurs first depends on the geometry of the situation.

C.11. All the encounters of the 'safety encounter model' correspond to situations with almost no horizontal separation (i.e. HMD lower than 500 feet at CPA). This is not necessarily the case in the vertical dimension since the model includes a significant proportion of encounters with vertical manoeuvres that increase the aircraft separation at closest approach. With regard to the 'ATM encounter model', almost all encounters correspond to situations in which the ATC separation minima are preserved.

<sup>14</sup> For minimum propinquity values greater than  $\sqrt{2}$ , the separation minima are preserved. For minimum propinquity values between 1 and  $\sqrt{2}$ , the precise encounter geometry needs to be considered to determine if there is a separation infringement or not. If the minimum propinquity is less than 1, a separation infringement exists.

## Appendix D. Implementation of the reference STCA model

D.1. The following figure provides an overview of the design of the STCA model implemented within the scope of the I-AM-SAFE study [WP12]. This implementation was deliberately kept as simple as possible.

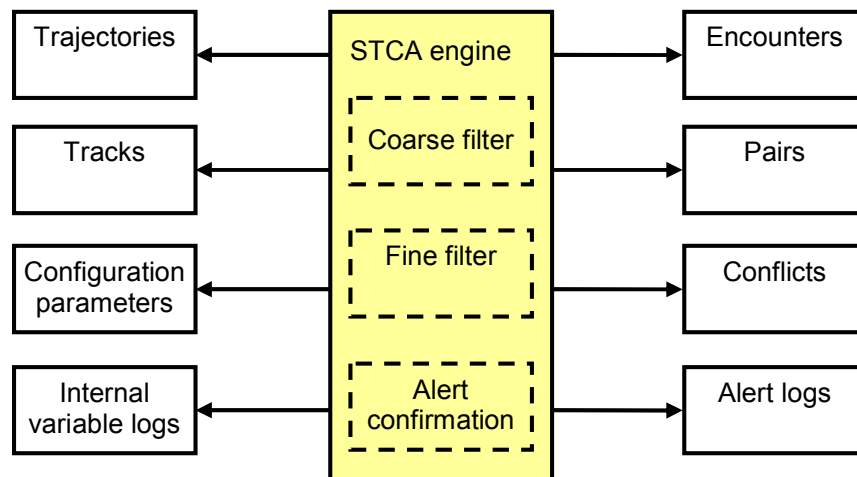

Figure 20: Simplified STCA model design

D.2. The three main functions implemented consisted of:

- A 'Coarse Filter' that finds pairs of system tracks that are of potential concern and that require further processing by the subsequent functions;
- A 'Fine Filter' that closely examines each pair of tracks and predicts if they are likely to come into conflict. Within the scope of the I-AM-SAFE study, this filter was limited to a 'Linear Prediction Filter';
- An 'Alert Confirmation' module that determines if an alert is required, either because of the proximity of the conflict or because the conflicting situation predicted earlier has not been solved. Within the scope of the I-AM-SAFE study, this confirmation was only associated to the 'Linear Prediction Filter'.

D.3. The implementation does not include many of the optional features defined in the EUROCONTROL guidance material for STCA [STCA2]. The only optional feature (option A) implemented is the possible use of the CFL in the vertical prediction of the 'Linear Prediction Filter'.

D.4. With regard to the input surveillance data provided to the STCA model, basic and nominal assumptions were taken (e.g. altitude tracking in 25 ft increments, or smoothed speed vector). Further, an STCA cycle duration of 4 seconds was assumed for the whole airspace.

## Appendix E. Scenarios of STCA simulations

E.1. Four sets of STCA configuration parameters were investigated during the study spanning a full range of high and low values of STCA parameters as follows.

STCA configuration parameter	TMA		En route	
	High value	Low value	High value	Low value
CoarseFilterPredictionTime	120	120	120	120
CoarseFilterLateralSeparation	5	5	8	8
CoarseFilterVerticalSeparation[vsep]	1000	1000	1000	1000
LinearPredictionTime	120	80	120	80
LinearPredictionLateralSeparation	2.5	2	4	2.5
LinearPredictionLateralSeparationDiverging	2	1.5	3	1.75
LinearPredictionVerticalSeparation[vsep]	750	500	750	500
UseCFLFlag	0/1	0/1	0/1	0/1
LinearPredictionImminentTime	50	35	50	35
LinearPredictionConflictCount	2	2	2	2
LinearPredictionCycleCount	4	4	4	4
LinearPredictionWarningTime	80	50	90	50

Table 1: STCA configuration parameters

E.2. Since the study was not specific to a given airspace, only one set of region-dependent parameters was defined for each scenario. In particular, it was assumed that a vertical separation minimum of 1,000ft applies in the whole airspace.

E.3. Not all sets of configuration parameters were applied to both the ATM and the safety encounter models. Instead, it was agreed that only the eight following scenarios would be investigated in the study:

- ✓ ATM model / TMA / with CFL / high values;
- ✓ ATM model / TMA / without CFL / high values;
- ✓ ATM model / En-route / with CFL / high values;
- ✓ ATM model / En-route / without CFL / high values;
- ✓ Safety model / TMA / without CFL / low values;
- ✓ Safety model / TMA / without CFL / high values;
- ✓ Safety model / En-route / with CFL / low values; and
- ✓ Safety model / En-route / with CFL / high values.

E.4. Since the ATM encounter model was not expected to generate many STCA alerts, the associated scenarios were focused on the high values of configuration parameters for a given airspace. For the safety encounter model, scenarios were defined with both the high and low configuration parameters for a probable use of the CFL option in the considered airspace, i.e. no use of CFL in TMA and use of CFL in en-route.

E.5. When using the CFL option, the quality of the CFL data provided to STCA may influence the likelihood of an alert. To assess this specific issue, two distinct sets of CFL data were simulated, which correspond to two extremes cases with or without CFL busts.

## Appendix F. Description of the OSCAR encounter display

- F.1. The OSCAR test bench is a set of integrated tools to prepare, execute and analyse scenarios of encounters involving TCAS II equipped aircraft (see [OSCAR]. for further details).
- F.2. This test bench has been adapted for the purpose of the I-AM-SAFE study to also display, for each encounter, the most relevant results of the STCA simulations performed using the simplified STCA model developed for the study purposes.
- F.3. The STCA simulation results are displayed on the trajectories of both aircraft according to the symbols and labels described hereafter:

<b>AL</b>	Start of alert for a selected aircraft
<b>▲</b>	Start of alert for the other aircraft
<b>TOV</b>	Time Of Violation (at the time of the alert)
<b>End</b>	End of alert

Figure 21: OSCAR symbols for the I-AM-SAFE study

- F.4. The original OSCAR test bench design was aircraft-centred and many of the displayed information are related to a selected aircraft. This explains the asymmetry in the display of the STCA simulation results.
- F.5. When considered relevant, the ACAS simulation results are also displayed on the aircraft trajectories. The RA updates are shown on the trajectory of the selected aircraft and ACAS status of the intruders on their respective trajectories, according to the symbols and labels described hereafter:

<b>◆</b>	<b>Proximate Traffic</b>
<b>●</b>	<b>Traffic Advisory</b>
<b>■</b>	<b>Resolution Advisory</b>
<b>LD2</b>	<b>Preventive RA</b>
<b>LD2</b>	<b>Corrective RA</b>

Figure 22: OSCAR symbols for ACAS simulation results

\*\*\* END OF DOCUMENT \*\*\*