

Standards for helicopter landing areas at hospitals

CAP 1264



Published by the Civil Aviation Authority, 2019

Civil Aviation Authority,
Aviation House,
Gatwick Airport South,
West Sussex,
RH6 0YR.

You can copy and use this text but please ensure you always use the most up to date version and use it in context so as not to be misleading; and credit the CAA.

First published 2016

First edition, first amendment published 2019

Enquiries regarding the content of this publication should be addressed to:

FSTechnicalSupportTeam@caa.co.uk

Future Safety,
Civil Aviation Authority Aviation House,
Gatwick Airport South,
West Sussex,
RH6 0YR

The latest version of this document is available in electronic format at www.caa.co.uk.

Contents

| | |
|---|-----------|
| Contents | 3 |
| Executive summary | 8 |
| Glossary and abbreviations | 10 |
| Chapter 1 | 14 |
| Introduction | 14 |
| Purpose and scope | 14 |
| Planning considerations and safeguarding arrangements | 16 |
| Heliport site selection (options)..... | 20 |
| Heliports at surface (ground) level, whether or not moulded..... | 20 |
| Elevated heliports (more than 3m above ground level) at rooftop level | 21 |
| Heliports on dedicated raised structures that are less than 3m above the surrounding surface | 21 |
| Refuelling..... | 23 |
| Heliport winterisation | 24 |
| Security..... | 24 |
| Magnetic field deviation | 25 |
| Chapter 2 | 26 |
| Helicopter performance considerations | 26 |
| General considerations | 26 |
| Factors affecting performance capability | 27 |
| Chapter 3 | 28 |
| Helicopter landing area – physical characteristics | 28 |
| General | 28 |
| Heliport design considerations – environmental effects..... | 30 |
| Effects of structure-induced turbulence and temperature rise due to hot exhausts | 32 |
| Heliport design – environmental criteria..... | 34 |
| Heliport structural design | 34 |
| Case A – helicopter landing situation..... | 35 |
| Case B – helicopter at rest situation | 37 |
| Size obstacle protected surfaces / environment | 37 |

| | |
|--|-----------|
| Surface | 45 |
| Helicopter tie-down points..... | 47 |
| Safety net..... | 48 |
| Access points – ramps and stairs | 49 |
| Lifts | 50 |
| Helicopter base facilities for a helicopter emergency medical services (HEMS) operation..... | 51 |
| Chapter 4 | 52 |
| Visual aids | 52 |
| General | 52 |
| Wind direction indicator(s) | 52 |
| Helicopter landing area markings | 54 |
| Helicopter landing area lighting..... | 58 |
| Obstacles – marking and lighting..... | 61 |
| Chapter 5 | 65 |
| Heliport fire-fighting services..... | 65 |
| Introduction | 65 |
| Key design characteristics for the effective application of the principal agent | 66 |
| Complementary media..... | 70 |
| The management and maintenance of media stocks | 71 |
| Equipment..... | 72 |
| Life-saving equipment..... | 72 |
| Emergency planning arrangements | 72 |
| Further advice..... | 73 |
| Chapter 6 | 75 |
| Miscellaneous operational standards..... | 75 |
| General precautions | 75 |
| Helicopter operations support equipment | 75 |
| Chapter 7 | 77 |
| Heliports located on raised structures..... | 77 |
| Concept and definition..... | 77 |
| Introduction | 78 |
| Helicopter performance considerations..... | 79 |

| | |
|--|------------|
| Physical characteristics..... | 80 |
| Visual aids | 80 |
| Heliport Rescue and Fire Fighting Services (RFFS) | 81 |
| Miscellaneous operational standards..... | 81 |
| Chapter 8 | 82 |
| Surface level and mounded heliports..... | 82 |
| Concept and definition | 82 |
| Introduction | 83 |
| Helicopter performance considerations | 84 |
| Physical characteristics..... | 86 |
| Visual aids | 87 |
| Heliport Rescue and Fire Fighting Services (RFFS) | 88 |
| Miscellaneous operational standards..... | 88 |
| Appendix A..... | 90 |
| Heliport checklist..... | 90 |
| Example of core items checklist..... | 90 |
| Appendix B..... | 100 |
| Bibliography | 100 |
| Civil Aviation Authority – CAPs and research papers | 100 |
| International Civil Aviation Organisation (ICAO) and European Aviation Safety Agency (EASA)..... | 100 |
| Other publications | 100 |
| Appendix C..... | 102 |
| An illustration of obstacle clearances in the backup area | 102 |
| Obstacle clearances in the backup area | 102 |
| Appendix D..... | 104 |
| Specification for Heliport Lighting Scheme: Comprising Perimeter Lights, Lit Touchdown/Positioning Marking and Lit Cross Marking | 104 |
| Overall Operational Requirement | 104 |
| Definitions | 105 |
| Lighting element | 105 |
| Segment | 105 |
| Sub-section..... | 106 |
| The perimeter light requirement..... | 106 |

| | |
|---|------------|
| Configuration | 106 |
| Mechanical constraints | 106 |
| Light intensity | 106 |
| Colour | 106 |
| Serviceability..... | 107 |
| The touchdown / positioning marking circle requirement | 107 |
| Configuration | 107 |
| Mechanical constraints | 107 |
| Intensity | 108 |
| Colour | 110 |
| Serviceability..... | 110 |
| The cross marking requirement | 110 |
| Configuration | 110 |
| Mechanical Constraints..... | 111 |
| Light Intensity..... | 111 |
| Colour | 112 |
| Serviceability..... | 112 |
| General characteristics | 113 |
| Requirements | 113 |
| Other considerations..... | 114 |
| Appendix E | 116 |
| Specifications for helicopter taxiways, taxi-routes and stands at surface level heliports.. | 116 |
| Helicopter ground taxiways and helicopter ground taxi-routes..... | 116 |
| Helicopter air taxiways and helicopter air taxi-routes | 118 |
| Helicopter stands | 119 |
| Helicopter ground taxiway markings and markers | 123 |
| Helicopter air taxiway markings and markers | 123 |
| Helicopter stand markings | 124 |
| Appendix F | 127 |
| Initial Emergency Response Requirements for elevated heliports – duties of Responsible Persons..... | 127 |
| Introduction | 127 |
| Responsible person(s) – duties to perform including following an incident or accident | 129 |

| | |
|---|------------|
| Addressing a helicopter crash which does not result in post-crash fire..... | 130 |
| Appendix G..... | 132 |
| Guidance for floodlighting systems at elevated heliports and heliports on raised structures | 132 |
| Introduction | 132 |
| General considerations for helideck floodlighting..... | 132 |
| Improved floodlighting system – (a modified extract from CAA’s letter to the offshore industry dated 9 March 2006) | 133 |
| Appendix H..... | 134 |
| Guidance on airflow testing of onshore elevated helipads | 134 |
| Appendix I | 135 |
| Risk assessment to determine the need for a dedicated heliport rescue and fire-fighting service (RFFS) at a surface level, mounded or raised HLS | 135 |

Executive summary

Air Ambulance Helicopters form an essential part of the UK's pre-hospital response to patients suffering life threatening injuries or illnesses. It is estimated that every day about 70 patients are treated using helicopters operating in the air ambulance role to helicopter landing sites (HLSs) located at hospitals in the United Kingdom. HLSs are routinely provided at hospitals for the transfer of critically ill patients by air ambulance helicopters and by helicopters operating in the Helicopter Emergency Medical Services (HEMS) role with facilities varying in complexity from a purpose built structure on a rooftop above the emergency department (ED), with integral aeronautical lighting and fire-fighting systems, to an occasional use recreational / sports field remotely located from the ED perhaps only equipped with an "H" and a windsock present.

The primary purpose of this CAP is to promulgate in detail the design requirements and options for new heliports located at hospitals in the United Kingdom that can also be applied for the refurbishment of existing helicopter landing sites. In all cases heliport design guidance is based on the international standards and recommended practices in ICAO Annex 14 Volume II. However, given the pivotal role of an HLS at a hospital for supporting the (often complex) clinical needs of the patient, it is equally important that the design of the heliport places, at its heart, the needs of the patient who is often critically ill. Consequently, the design of a heliport needs to ensure that it is both 'safe and friendly' for helicopter operations, and, given the clinical needs of the patient, that its proximity to the hospital's Emergency Department (ED) affords rapid patient transfer and avoids the complication of a secondary transfer by land ambulance. Patient transfer from the HLS to the ED should be expedited in a manner that upholds both the dignity and security of the patient and the safety and security of staff tasked to complete a transfer of the patient to ED potentially in all weather conditions.

A landing area that is remote from the ED, and so entails a lengthy patient transfer from the helicopter, perhaps requiring a transfer to another form of transport and/or protracted exposure to the elements, is then not serving the patient who is in need of the most prompt care, who may be suffering from trauma, cardiac or neurological conditions; all of which are highly time critical. It is therefore strongly recommended that new build design or refurbishments take these factors fully into consideration, by ensuring early consultation with those people at the hospital who have a direct responsibility for the clinical needs of a patient.

The safety of helicopter operations is clearly paramount to any design for an HLS at a hospital and there can be no alleviations from the regulations due to the emergency nature of an operation. In the interests of most easily assuring the optimum operating environment for helicopters, this CAP promotes the design of elevated (rooftop) heliports, as the 'package' most likely to deliver a safe and friendly environment for helicopters

operating to a hospital landing site (HLS) in the UK. This focus is chosen because heliports located at a good height above ground level, usually at rooftop level, tend to provide the best long-term operating environment for helicopters, by raising the landing area up above obstacles which might otherwise compromise flight operations. An elevated heliport, in addition to delivering the best safety outcomes for the helicopter and facilitating the complex needs of a critically ill patient, also has the best potential to deliver more effectively on environment performance, by reducing the incidence of helicopter noise and downwash at surface level, and delivering a more secure HLS - by creating a landing site that is securely protected from inadvertent or deliberate entry by members of the public.

However, in recognising that a rooftop heliport may not be the preferred solution for every hospital, the CAP also provides supplementary guidance for landing sites at hospitals provided on raised structures which, although above surface level, are less than 3m above the surrounding terrain (and not classed as elevated heliports) and for helicopter landing sites which are at surface level, including mounded. Given the challenges and complexity of designing an HLS able to balance the sometimes competing demands for effective patient care with the need for a safe, efficient and friendly environment in which to operate helicopters, it is recommended that a hospital Trust / Board engages the services of a competent third party heliport consultant, and in addition seeks the advice and guidance of those who have the primary responsibility to deliver effective patient care.

In assuming the primary users of a helicopter landing site at a hospital will usually be the local air ambulance and/or HEMS operator, consideration should also be given to other remote users, perhaps not exclusively operating to an HLS in the air ambulance or HEMS role. Other users may include, but may not be limited to, Police helicopters and other emergency services and the civilianised search and rescue (SAR) operation, dispatching SAR assets from 10 bases around the UK coastline. Hence for the design of an HLS the critical helicopter may not be the one that most regularly uses the heliport, but a helicopter, perhaps acting in a lesser seen role, which is the combination of the heaviest helicopter and the one requiring the largest landing area in which to operate. The issue of identifying the design helicopter is sometimes complicated by the fact that both critical attributes may not reside in a single helicopter and in this case the designer of an HLS will need to consider two or more types (or type variants) for the basic design. Notwithstanding, most HLSs will need to consider a range of helicopters, from small to medium twins operating in the air ambulance role to larger helicopters operating in the SAR role.

It is not the purpose of this civil aviation publication to consider the use of military helicopters at a hospital HLS. As many of the types routinely used by military services are heavy or extra-heavy helicopters, a design to incorporate military types may present particular challenges for the siting of an HLS at a hospital. Given the potentially low usage by military types, it may be prudent to consider a secondary helicopter landing site at or near the hospital which can be used on an occasional basis to accommodate military helicopters.

Glossary and abbreviations

| | |
|------------------------------|---|
| AAA | Association of Air Ambulances Ltd |
| AFM | Aircraft flight manual |
| ANO | Air Navigation Order |
| CAP | Civil Aviation publication |
| Cd | Candela |
| Congested area | An area in relation to a city, town or settlement which is substantially used for residential, industrial, commercial or recreational purposes. |
| DCP | Development Control Plan - a documented arrangement provided by the hospital's Trust / Board for the control (i.e. limitation) of developments around the heliport which could impact on the operability of the heliport. |
| DoH | Department of Health (in relation to DoH Health Building Note HBN 15:03 Hospital helipads) |
| DIFFS | Deck integrated fire-fighting system |
| D-value | The largest dimension of the helicopter when rotors are turning. This dimension will normally be measured from the most forward position of the main rotor tip path plane to the most rearward position of the tail rotor tip path plan (or the most reward extension of the fuselage in the case of Fenestron or Notar tails). |
| Design (critical) helicopter | The helicopter types (or type variant) which is the combination of the heaviest helicopter and the type |

| | |
|--------------------------------|--|
| | requiring largest landing area (FATO) in which to operate. This requirement could be contained within one or more types (or type variants). |
| ED | Emergency department |
| EIA | Environmental impact assessment |
| Elevated heliport | A heliport located on a raised structure at 3m or more above the surrounding terrain. For the purpose of this CAP this is usually supposed to be a purpose-built structure located on a rooftop, ideally at the highest point of the estate. |
| FATO | Final approach and take-off area |
| FFS | Fire-fighting service (term does not include rescue arrangements) |
| FMS | Fixed monitor system |
| FOI | Flight operations inspector (of the UK CAA) |
| FOI (H) | Flight operations inspectorate (helicopters) |
| FOI (GA) | Flight operations inspectorate (general aviation) |
| Heliport | An aerodrome or a defined area of land, water or a structure intended to be used wholly or in part for the arrival, departure and surface movement of helicopters. |
| Heliport on a raised structure | A heliport located on a raised structure less than 3m above the surrounding terrain. |
| HEMS | Helicopter emergency medical services |
| HLS | Helicopter landing site |

| | |
|---------------------|---|
| Hostile environment | An environment in which a safe forced landing cannot be accomplished because the surface is inadequate or the helicopter occupants cannot be adequately protected from the elements or SAR capability is not provided consistent with anticipated exposure or there is an unacceptable risk of endangering persons or property on the ground. |
| ISO | International Organisation for Standardisation |
| MTOM | Maximum take-off mass |
| OM | Operations manual |
| PC1 / 2 / 3 | Performance class 1 / 2 / 3 |
| PinS | Point-in-space |
| PPE | Personal protective equipment |
| PPEWR | (HSE) Personal Protective Equipment at Work Regulations |
| PUWER | (HSE) Provision and Use of Work Equipment Regulations |
| RD | Rotor diameter |
| RFFS | Rescue and fire-fighting service |
| RFM | Rotorcraft flight manual |
| RTODAH | Rejected take-off distance available (helicopters) - the length of the FATO declared available and suitable for helicopter operated in performance class 1 to complete a rejected take-off. |

| | |
|------------------------|---|
| SAR | Search and rescue |
| Secondary HLS | A second HLS provided for larger helicopters, including military helicopters, which is not authorised to land at the primary HLS. |
| SLS | Serviceability limit state |
| Surface level heliport | A heliport located on the ground which if specifically prepared and landscaped may consist as a mounded heliport. |
| TDP | Take-off decision point |
| TD / PM circle | Touchdown / positioning marking circle |
| TLOF | Touchdown and lift-off area |
| 't'-value | The MTOM of the helicopter expressed in metric tonnes (1000 kg) expressed to the nearest 100 kg. |
| ULS | Ultimate limit states |
| UPS | Uninterrupted power supply |
| VSS | Visual segment surface |

Chapter 1

Introduction

Purpose and scope

- 1.1 The purpose of this CAP is to address the design requirements and options for new heliports located at hospitals in the United Kingdom. The requirements relate to new build facilities or to the refurbishment of landing sites at both existing and new hospitals. As well as setting out in detail the design requirements for hospital heliports, this CAP also provides guidance on their operation and management. This CAP may therefore be assumed to have superseded Department of Health (DoH), Health Building Note 15-03: Hospital Helipads, which was regarded as the principal guidance document for the design and operation of hospital helipads in the UK between 2008 and 2016. The DoH HBN is now withdrawn.
- 1.2 This CAP should not be considered an exclusive reference source since under the UK Air Navigation Order (ANO), the helicopter operator ultimately has the responsibility for deciding whether a heliport is safe for use within the constraints of operational requirements laid out in the company Operations Manual (OM) and the Rotorcraft Flight Manual (RFM). Therefore expert aviation advice should be sought before committing to any final design and expenditure. This advice could be sought from an independent helicopter consultant, or via an aviation consultancy organisation,¹ given in tandem with specific advice from end-users e.g. the local air ambulance, Search and Rescue (SAR) and/or HEMS operators.
- 1.3 The primary focus of this Civil Aviation Publication is on the interpretation and application of heliport design requirements that are based on the international standards and recommended practices in Annex 14 Volume II. However, it is also important that the design of the heliport at a hospital places, at the heart, the needs of the consumer who is an often critically ill, patient. So the design of the heliport needs not only to ensure it is 'safe and friendly' for helicopter operations, but, given the often critical condition of the patient, that the proximity to a hospital's Emergency Department (ED) affords rapid patient transfer in a manner that upholds their care and dignity. A landing area that is remote from the ED, and so requires a lengthy patient transfer from the helicopter, perhaps involving protracted exposure to the elements, is then not serving the patient in need of the most prompt care, who may be suffering from trauma, cardiac or neurological conditions which are highly time critical. It is strongly recommended

¹ For example, CAA International Ltd

that any new build design should take these elements fully into consideration, by ensuring consultation with those at the hospital who have a direct responsibility for the clinical needs of the patient.

1.4 This CAP provides reference material for the application of a range of specialisations that may have an interest in the design and operation of the heliport including, but not necessarily limited to:

- Trust chief executives and directors considering a business case and options for helicopter access;
- Head clinicians considering pre-hospital care;
- Estates and project managers and private sector partners tasked to approve the design and build of heliports;
- Fire and safety officers considering risk analyses and safety and contingency plans;
- Helicopter operator end-users whether air ambulance helicopters, search and rescue (SAR) or HEMS helicopters or police helicopters.

Note: The design and operational requirements provided in this CAP intentionally do not seek to address the specific needs of military helicopters. Nonetheless a range of helicopters may need to be considered in an initial heliport feasibility design study which may include a requirement to accommodate heavy or extra- heavy military helicopters.

1.5 In the interests of promoting the optimum operating environment for helicopters, this CAP places the primary focus on elevated (rooftop) heliports, as the preferred option for a hospital landing site (HLS) facility in the UK. This focus is chosen because heliports located at elevation, on a rooftop, tend to provide the best long-term operating environment for helicopters, by raising the landing area up above obstacles which might otherwise compromise flight operations. However, the CAP also provides supplementary guidance for landing sites at hospitals that may be provided on raised structures which, although above surface level, at less than 3m above the surrounding terrain, are not classed as elevated heliports (see Chapter 7). For completeness supplementary guidance for surface level heliports, including heliports on mounded surfaces, are addressed in Chapter 8. Although the guidance is presented in the context of a helicopter landing site at a hospital, much of the good practice can be applied to any unlicensed helicopter landing site facility, whether or not located at a hospital. There are, however, subtle differences for 'non-hospital' helicopter landing sites, such as the characteristics of some markings and, in these cases, it is prudent to consult other reference sources; the British Helicopter Association's 'Helicopter Site Keepers – A Guidelines Document produced and updated with the assistance of the Civil Aviation Authority', <https://www.britishhelicopterassociation.org/?s=site+keepers> and [CAP 793](#), Operating Practices at Unlicensed Aerodromes, as well as other sections of

Annex 14 Volume II, before embarking on a project not intended to service Air Ambulance / HEMS operations etc (see Appendix B).

- 1.6 Under the current UK Air Navigation Order (ANO) there is no statutory requirement for an HLS at a hospital to be licensed by the CAA. However, helicopter operators should be satisfied with the landing area arrangements including the provision of Rescue and Firefighting Services and, that the adequacy of aeronautical lighting displayed at the heliport is suitable for night operations, where applicable. The heliport operator may accept a third party 'sign off' of the heliport structure and associated systems including RFFS. However, CAA Flight Operations (Helicopters) Flight Operations Inspectors (FOIs) reserve the right to attend an operator's (non-commercial) flight authorisation to allow lighting systems to be assessed from the air before a final sign-off for night operations can occur.

Planning considerations and safeguarding arrangements

- 1.7 Since helicopter-borne patients are likely to be in a time critical condition (see paragraph 1.3) it is important that the time taken to transfer them between the helicopter and the hospital's Emergency Department (ED) is as short as possible and that the patient is spared a lengthy transfer from the helicopter to a place of medical care which should not involve protracted exposure to the elements i.e. the route for the patient is unprotected from adverse weather conditions. The safest, fastest and most efficient means for a rooftop heliport is likely to be by trolley transfer from the helicopter straight to a dedicated lift at or just below heliport level or, for a purpose-built raised heliport, via a short access ramp connecting the heliport to the surrounding surface level. For a ground level helipad, there will be no need for either a lift or a ramp, but where necessary a covered walkway from the edge of the helipad safety area to the ED should be included in the design, consisting in a concrete or tarmac pathway between the two. Transferring patients from a helicopter to a road ambulance for an additional journey to ED is to be avoided, especially where a patient is critically ill and is in need of prompt care. The best locations for a helicopter landing site are deemed to be on a roof above ED or, where practical, in an open area adjacent to it.
- 1.8 A heliport design requires that a defined area free of obstructions such as buildings and trees be provided to facilitate at least two approach and take-off/ climb 'corridors' rising from the edge of the heliport; an area free of limiting obstructions that will allow helicopters to safely approach to land and, where required by the specific operating technique, to back-up before departure, in a forward direction, from the heliport. If new obstructions are built or grow up in defined areas, helicopters may no longer be able to operate or may be severely

restricted. It is therefore important that the location of the heliport be considered in the light of the potential future developments around the heliport, whether within or just beyond the boundaries of the hospital estate. If obstructions such as tall buildings are erected, which may have an associated use of cranes, or if trees are allowed to grow-up within the approach and/or departure corridors, the landing site may become restricted or unusable. NOTAMs should be raised by a hospital for any activity of a temporary nature, such as the requirement to erect cranes for construction, whether occurring within the hospital estate or in proximity to the hospital. All crane activity should be reported directly to the helicopter operator. [CAP 738](#), Safeguarding of Aerodromes, referenced in the bibliography section of this publication can offer further guidance to NHS Trust Estates Departments to help them assess what impact any proposed development or construction might have on the operation of an HLS. This assessment process is known as safeguarding and should be formally documented in a hospital's Development Control Plan (DCP). The safeguarding process described in CAP 738, and presented in the DCP, should be referenced whenever new buildings or facilities are planned.

- 1.9 HLS's are likely to attract the need for local authority planning permission - especially where they are anticipated to be used on more than 28 days in any calendar year. In addition they will require the permission of the land owner and the awareness of the local police to operate.
- 1.10 All helicopters in flight create a downward flow of air from the rotor system known as rotor downwash. The severity of downwash experienced is related to the mass of the helicopter, the diameter, and design of the rotor disc and the proximity of the helicopter to the surface. The effects of downwash can be unpredictable given they are influenced by ambient wind and temperature conditions at the time. The characteristics of downwash from some helicopters are known to exhibit a localised hard jet, as opposed to a disturbance that occurs over a larger area. Although more localised in its impact, a hard jet tends to be more intense and disruptive on the surface. The intensity of the downwash may be affected by the dissipating action of any wind present or by the screening effect of local features such as buildings, trees, hedges etc. The downwash in an area beneath large and very large helicopters, and beneath even a small helicopter operating at high power settings (such as are used during the upwards and rearwards portion of the take-off manoeuvre by some air ambulance types) can be intense, displacing loose hoardings and blowing grit and debris at persons, property or vehicles in the vicinity of the heliport. Loose objects can pose a risk to the helicopter itself if sucked up by re-circulating air flows into the rotor blades or engines. For small light air ambulance helicopters, performing clear area take-off manoeuvres, the effects are greatly reduced but still need to be considered particularly as, depending on the meteorological conditions on any given day, these same helicopters may be required to use a

helipad profile. Therefore, it is prudent for designers always to plan for the worst-case downwash profile for the design helicopter. The attached link gives some guidance on downwash effects and although the offshore operating environment is different, there are general principles cited that are common also to hospital HLSs <https://www.youtube.com/watch?v=09bvuyRKwwc>

- 1.11 For a surface level heliport operating exclusively light air ambulance helicopters it is recommended that a minimum 30m downwash zone be established around the heliport which is kept clear of people, property or parked vehicles (typically 2 to 3 rotor diameters of the helicopter). The downwash zone, to account for the approach to land and take-off manoeuvres, may need to be extended in the portion below the helicopter flight path to account for operating techniques which promote local disturbances, such as when a helicopter pilot applies full power during the rearward portion of the take-off. If heavy or extra heavy helicopters are to be utilised at surface level, the downwash zone established around the heliport should be considerably larger; typically between 50m and 65m for the largest helicopters.
- 1.12 Although currently most air ambulances operate during day light hours only, there are initiatives within the industry to provide a 24 hour / 'round the clock' service. It is therefore recommended that all new heliports should be equipped with appropriate aeronautical lighting (the latest systems are described in detail in Chapter 4). For night operations, involving the public transport of helicopters, the Air Navigation Order (ANO) places a duty on the heliport site keeper to provide suitable and effective aeronautical lighting systems for take-off and for approach to land which enables the helicopter operator to identify the landing area from the air at the required ranges (see Appendix D). Discharging this responsibility includes providing at least one trained person for night operations to ensure that the lights are functioning correctly and that no persons or obstacles have strayed into the operating area, and where authorised to do so, to communicate with the pilot by radio before the helicopter arrives until after the helicopter has departed.
- Note:** Radio facilities are required to be approved to at least an Air / Ground Communications Service (AGCS) and operators licensed as appropriate – see CAP 452, Aeronautical Radio Station Operator's Guide.
- 1.13 To address environmental issues including noise nuisance, Circular 02/99 Environmental Impact Assessment (EIA) was the guidance in force until March 2014, and this stated that in terms of the construction of airfields:
- 1.14 "The main impacts to be considered in judging significance are noise, traffic generation and emissions. New permanent airfields will normally require EIA, as will major works (such as new runways or terminals with a site area of more than 10 hectares) at existing airports.

Smaller scale development at existing airports is unlikely to require EIA unless it would lead to significant increases in air or road traffic.”

- 1.15 For a hospital landing site the occasions when helicopters could cause disturbance are likely to be irregular, few in number and short in duration. As a result a formal noise analysis for hospital heliports is unlikely to draw fully objective conclusions and may be of only limited assistance to planning committees; however, checking with the Local Authority will help ascertain whether they require an Environmental Impact Assessment to be carried out.
- 1.16 The environmental impact, balanced against the positive benefit for patients and for the community at large, should be explained to the local population at an early stage of the project and especially during the mandatory consultation phase. The public can appreciate the value of a hospital heliport in life saving situations, especially when fully informed of the purpose and importance, the likely infrequent and short duration of any environmental impact and any mitigation activities proposed which could include:
- Locating the heliport on the highest point of the estate, for example, on top of the tallest building;
 - Designing the flight paths to avoid unnecessary low transits over sensitive areas;
 - Employing noise abatement flight paths and using approach and departure techniques which minimise noise nuisance;
 - Dissipating noise using baffles formed by intervening buildings and trees;
 - Insulating buildings and fitting double glazing in vulnerable zones;
 - Limiting night operations by transporting only critically ill patients during unsociable hours (2300 to 0700 hours).
- 1.17 Permitting the use of the heliport by non-emergency helicopters belonging to third parties, whilst it may generate extra revenue, is likely to attract a more antagonistic public reaction to the environmental impact of helicopter movements. In addition permitting these helicopter movements may exceed the hospital's planning permission, incur additional administrative and operational personnel responsibilities and create issues of access and security; especially where passengers have to alight from the heliport through hospital buildings. In addition the situation could arise where non-emergency helicopters are found to block the heliport from receiving emergency helicopters acting in life saving roles.
- 1.18 This CAP describes the requirements for the provision of a single primary heliport accommodating one helicopter at a time on the premise that this operating arrangement should be sufficient for most hospitals. However, major trauma hospitals and others that might expect to receive mass casualties involving two or more helicopters arriving simultaneously may need to consider a second location for helicopters to land at. Preferably, a secondary helicopter

landing site should be located close to the ED, but with real estate often at a premium, it is more likely a secondary HLS will have to be located for the transfer of non-critical patients, some distance from the ED perhaps beyond the hospital boundary (e.g. in a local park). In these cases consideration should be given to ease of transfer by road ambulance and any options identified should be discussed with landowners, local police and fire services. The requirement to activate a secondary site should be included in the hospital's emergency response plan.

- 1.19 As an effective alternative to a secondary HLS it may be possible to configure the primary HLS so that it is supported by a simple network of air or ground taxiways capable of servicing one or more parking spots. This option is discussed further in the context of surface level operations, in Appendix E, but could equally be applied at rooftop level.

Heliport site selection (options)

- 1.20 There are principally three options for siting of an HLS: at surface (ground) level (a variation of this type is a mounded heliport specifically landscaped and constructed for the purpose); at elevated (rooftop) level at a height of more than 3m above the surrounding surface; or a purpose built raised structure that is less than 3m above the level of the surrounding surface. Elevated heliport design is addressed in detail in chapters 3 to 6. Supplementary requirements for heliports provided on a raised structure (less than 3m above the surrounding surface) are addressed in Chapter 7 while supplementary requirements for surface (ground) level heliports, including mounded heliports, are addressed in Chapter 8.

Heliports at surface (ground) level, whether or not moulded

- 1.21 Heliports built at surface (ground) level are the least expensive to construct and to operate. However, suitable ground level areas are at a premium at most hospitals and are usually being used for buildings, for car parks or for amenity areas (car parking in particular is regarded a good revenue generator at hospitals and the economic case for sacrificing car parking areas to facilitate the considerable space requirements for a ground level heliport need to be carefully weighed). It should also be borne in mind that HLSs at surface level are the most difficult to secure from the public (whether from inadvertent or deliberate entry) and are most susceptible to noise nuisance and downwash effects. Moreover unless they can be located in close proximity to the ED, they may not satisfy the clinical needs of a critically ill patient.
- 1.22 It should be appreciated that ground level sites capable of accommodating helicopters using a clear area operating technique will require more space than for helicopter that operate other approved profiles; whether helicopters operate a helipad profile / vertical 'procedure' or a 'short field procedure'. Whatever

procedure is utilised, heliports are required to accommodate at least two take-off climb and approach surfaces creating 'airways' (generally aligned to take advantage of the prevailing wind conditions) that are free of obstructions which could compromise obstacle limitation surfaces. This is particularly challenging for a ground level facility, likely situated in a densely built up area and so requiring the removal of screening such as trees and shrubs. Providing a mounded heliport may assist to raise-up the level of an HLS to clear ground level obstructions, however, it may be difficult, and is frequently impossible, to find the necessary operating area within an acceptable distance of ED; in which case the option for a raised or elevated heliport should then be considered.

Elevated heliports (more than 3m above ground level) at rooftop level

- 1.23 From both the aviation, environmental and long-term planning perspectives the best position for an HLS is on the roof of the tallest building at the site. Rooftops are generally unused spaces and even if there is air conditioning plant situated on the roof, a purpose-built heliport can usually be constructed above it. Rooftop locations raise the helicopters' approach and departure paths by several storeys and reduce the environmental impact of helicopter operations; in particular noise nuisance and the effects of downwash at surface level. Rooftop heliports are likely to provide a greater choice of approach path headings (to realise maximum operability this will ideally be 360 degrees allowing the helicopter to take full advantage of a headwind component at all times. However, this 'ideal' situation needs to be weighed against the need to provide lift transfer, at or just below heliport level). In addition elevated rooftop heliports are less likely to influence, or be influenced by, future building plans.
- 1.24 However, heliports at rooftop level are generally more expensive to build as they require integral fire fighting facilities and have needed dedicated trained crews to operate the fire-fighting equipment (this dictated that the future ongoing operational costs were high). A heliport on the roof of a building housing the ED, with a flat ramp to provide trolley access straight to a dedicated lift to one side, usually offers the shortest transit and minimises exposure of a patient to the elements. The cost of a rooftop heliport can be controlled by including an HLS provision in the initial design of the building.

Heliports on dedicated raised structures that are less than 3m above the surrounding surface

- 1.25 An HLS built on a structure that is raised by less than 3m above the surrounding area, when subjected to a thorough risk analysis, may not be required to provide an integral FFS with the potential associated ongoing operational costs of training of crews, replenishment of media etc. Therefore a heliport built on a one-storey structure above a car park or other area in close proximity to the ED may afford some economic advantages over an elevated (rooftop) heliport.

- 1.26 In addition a heliport on a raised structure gives some operational advantages over a surface level heliport as it need not occupy valuable real estate at surface level within the grounds of the hospital. Compared to ground-level sites, raised heliports are more likely to achieve unobstructed approach and take-off flight paths and are to a small degree less likely to impact on future building plans.
- 1.27 By raising an HLS by one storey this may have some limited beneficial impact on harmful environmental issues (such as noise nuisance, rotor downwash effect etc) created by the helicopter operation; benefits are confined to the case of smaller air ambulance helicopters. However, it is unlikely that raising the HLS by just a single storey will provide any benefit for larger helicopter operations. In particular the severe downwash effects created by larger types can make operations to heliports on raised structures challenging; due to the risks posed to third parties who may be moving around under final approach areas and due to the possibility of damage to nearby vehicles and/or property e.g. a raised HLS directly above, and/or surrounded by a public car park. Where operations by very large helicopters are to be facilitated, often the only way to reduce the detrimental environmental impact is to locate the HLS above a tall building (preferably the tallest on the estate).

Table 1-1: Comparison of ground level, mounded, raised and rooftop sites

| | Ground level | Mounded | Raised structure | Elevated (rooftop) |
|--|--------------|---------|------------------|--------------------|
| Aircraft and public security | | | | |
| Freedom from obstructions at ground level | | | | |
| Freedom from obstructions in helicopter approach corridors | | | | |
| Provision of into-wind approaches | | | | |
| Minimising downwash effects / noise nuisance to the public and effects on property | | | | |
| Reducing the impact of trees and shrubs | | | | |
| Preservation of trees and shrubs | | | | |
| Impact on future building plans | | | | |

| | Ground level | Mounded | Raised structure | Elevated (rooftop) |
|---|--------------|---------|------------------|--------------------|
| Minimising building costs (CAPEX) | Green | Amber | Red | Red |
| Minimising running costs (OPEX) | Green | Green | Amber | Red |
| Mandatory requirement for integrated fire-fighting equipment | Green | Green | Amber | Red |
| Mandatory requirement for trained manpower available for each landing | Green | Green | Amber | Amber |

Key: Colour coding indicates the relative ease or difficulty of meeting certain criterion for each main type of heliport.

Green = easiest, **amber** = moderate, **red** = most difficult

Disclaimer: For some aspects the colour coding used is quite subjective and so the Table should be viewed as providing only general comparative guidance between the various heliport options (for example: adopting an aluminium construction means an easy to build, lighter construction and lower-in-maintenance solution than a comparable steel construction).

Refuelling

- 1.28 It is unusual for a hospital heliport to have a requirement for the installation of a dedicated on-site bulk storage fuelling service and it is not the intention of this CAP to specifically address this option. However, most hospitals will be located within easy reach of a licensed aerodrome where fuelling services will be available, and in many cases offering a refuelling service on a 24/7 basis. However, if for reasons of convenience and economy there is a requirement for an operator to dispense fuel when operating at a hospital landing site then the easiest, and least administratively demanding option for the hospital, will be an arrangement to facilitate a helicopter operator to dispense aviation fuel from barrels via an integrated pump.
- 1.29 If an operator is to dispense aviation fuel from barrels, it will be necessary to provide a small, secure covered accommodation to typically house up to 4 (200L) drums and a pump. This small secure covered accommodation, provided with an aircraft obstruction light, will need to be located in the vicinity of the helipad and serviced by a hard / firm pathway used to move barrels from store to aircraft. Alternatively, a helicopter operator may elect to bring in their own

refuelling bowser or trailer mounted tank which will yield greater mobility and flexibility than do static tanks or drums. A bowser or trailer can be sited nearby and driven or towed close to the helipad whenever required.

- 1.30 By whatever method fuel is provided and dispensed by a helicopter operator, issues of fuel quality control and security and dispensing accountancy all remain the responsibility of the helicopter operator (and not the Board / Trust). If a dedicated bulk storage installation is to be provided on site, then responsibility for the day-to-day operation and fuel quality control passes across to the Board / Trust. Before implementing this option the Board / Trust should be fully appreciative of the scrupulous VAT requirements that will be imposed by HM Revenue Services on a dedicated refuelling service at a hospital, both in initially clearing the facility, and then in the regular and random inspection of the facility and auditing of associated records.
- 1.31 Further detailed advice on helicopter fuelling can be found in [CAP 748](#), Aircraft Fuelling and Fuel Installation Management, and [CAP 437](#), Standards for Offshore Helicopter Landing Areas – chapters 7 and 8.

Heliport winterisation

- 1.32 Heliports at which there is an expectation for helicopters to operate regularly in sub zero conditions, may wish to incorporate an electrical heat tracing system to prevent the build-up of snow and ice throughout the entire landing area. Aluminium, widely used in the construction of purpose-built heliports, is known to be a good conductor of heat (having about three times the thermal conductivity of steel), and electrical heating cables can be integrated in the aluminium planking profiles (materials used for cabling should not have a detrimental effect on heliport surface friction and ideally should not protrude above surface level). In consideration of the poor thermal performance of concrete (low conductivity, high inertia), heat tracing electrical cables are not recommended for use with a concrete surface. An efficient electrical heat tracing system incorporated into the heliport design should remove or minimise the labour-intensive need to clear snow and ice manually (see Chapter 6, section 6.4d)

Security

- 1.33 It is important that the security of the helicopter and the heliport be fully considered to keep malicious persons and straying members of the public from encroaching onto the operating area and/or from tampering with the helicopter. A heliport operation is regarded as “airside” and therefore should be kept secure and free of FOD. Access to the heliport should be restricted to those personnel

who have an operational requirement to be there e.g. heliport manager, security staff, porters and clinical teams dispatched to receive a patient etc.

Magnetic field deviation

- 1.34 Helicopter heading indicators and stabilisation systems cue wholly, or in part, from the earth's magnetic field. Aluminium heliport constructions will not normally produce or interact with a magnetic field however the heliport substructure, where steel is selected, and/or where ancillary services such as electrical cabling and water pipes are incorporated, can generate a significant magnetic field. This field may differ in direction to the natural magnetic field, which in turn will be detected by the helicopter. It is therefore encouraged that magnetic north is initially established to be true for the site, and re-validated before and after key stages of the construction (i.e. "North" is still observed, by compass to be correct). Where possible any deviations should be corrected during construction. Any final magnetic field deviation should be notified to helicopter operators."

Chapter 2

Helicopter performance considerations

General considerations

- 2.1 The guidance given in this chapter is relevant for UK civil registered helicopter's operating to onshore heliports at hospitals and in particular those operating in accordance with EASA Requirements for Air Operators, Operational Requirements Part-OPS, Annex IV Part-CAT or Annex VI Part-SPA. The basic premise in design is that helicopters should be afforded sufficient space to enable them to operate safely at all times to heliports located in an environment that is usually classed as both "congested" and "hostile" (see glossary of terms for a congested and hostile environment).
- 2.2 For helicopters operating in a congested hostile environment EASA Requirements for Air Operators, Part-OPS, Annex IV Part-CAT (Sub Part C Performance and Operating Limitations (POL)) and Annex VI Part-SPA (Sub Part J Helicopter Emergency Medical Service operations (HEMS)) require that these be conducted by helicopters operated in performance class 1 (PC1) (see glossary of terms for performance class 1, 2 and 3 operations). This entails that the design of the heliport should provide a minimum heliport size that incorporates a suitable area for helicopters to land safely back onto the surface in the event of a critical power unit failure occurring early in the take-off manoeuvre. This is assigned the Rejected Take-Off Distance Available for helicopters (RTODA (H)).
- 2.3 The helicopter's performance requirements and handling techniques are generally contained in Rotorcraft Flight Manual Supplements (RFMS) which includes, where appropriate, performance data and operating techniques applicable for type at an elevated heliport. In considering the minimum elevated heliport size for PC1 operations, the RFMS should publish dimensions that have been established by manufacturer during flight testing taking into account the visual cueing aspects for the helicopter with All Engines Operating (AEO) and incorporating the Rejected Take-Off Distance (RTOD) for the helicopter in the event of a critical power unit failure occurring before take-off decision point (TDP); in which circumstances the helicopter is required to make a One Engine Inoperative (OEI) landing back to the surface (see glossary of terms). In addition to accommodating an adequate RTOD, the minimum dimensions prescribed in the RFMS establish a minimum elevated heliport size that incorporates suitable visual cues to enable a pilot to perform a normal All-Engines Operating (AEO) landing and a safe OEI landing. These issues are discussed further in Chapter 3 where it is generally concluded that heliport designers need to adopt a cautious

approach to determining minimum elevated heliport dimensions by sole reference to those published in the RFMS. In taking account of all considerations, including an assurance of safe surface movement around the helicopter, this should drive designers towards a minimum elevated heliport size that may be larger than the type-specific dimensions published in the RFMS.

- 2.4 When designing for a suitably sized heliport, hospitals will usually need to consider a range of helicopter types (Air Ambulance, Police and other emergency services, HEMS, SAR etc) and identify the most critical type, which will become the design helicopter; every type is required to publish approved profiles for an elevated heliport, and be capable of operating to performance class 1 rules. Therefore at the design concept stage it will usually be necessary to consider performance data for a range of suitable helicopters (including, where possible, future helicopter types that may be under development for similar roles and tasks). Even for the case where a single helicopter type operation is initially envisaged, it is always prudent to consider the future usage aspects of the heliport with the probable introduction of other helicopter types later on.
- 2.5 The dimensional aspects of the landing area are addressed in more detail in Chapter 3. An illustration of a typical profile for helicopters operated in performance class 1, which may also include a requirement for obstacle accountability to be considered in the helicopter's back-up area, are illustrated in Appendix C.

Factors affecting performance capability

- 2.6 On any given day helicopter performance is a function of many factors including the actual all-up mass; ambient temperature; pressure altitude; effective wind speed component; and operating technique. Other environmental factors, concerning the physical airflow characteristics at the landing area and any associated or adjacent structures which may combine to influence the performance of helicopters. These factors are taken into account in the determination of specific and general limitations which may be imposed in order to assure adequate performance margins are maintained and to ensure any potential exposure period is addressed. These limitations may entail a reduction in the helicopter's mass (and therefore payload) and in the worse case, an outright suspension of flying operations in certain conditions. It should be noted that, following the rare event of a power unit failure (after TDP), it may be necessary for a helicopter to descend below the level of an elevated heliport to gain sufficient speed to safely fly away.

Chapter 3

Helicopter landing area – physical characteristics

General

- 3.1 This chapter provides guidance on the physical characteristics, including the obstacle limitation surfaces and sectors necessary for the establishment of a safe and efficient elevated heliport operation. It should be noted that while the overall load bearing capability of the landing area is usually determined as a function of the maximum take-off mass (MTOM) of the heaviest helicopter intending to operate to the heliport, factors that determine the appropriate heliport dimensions are less straightforward. It is evident that the minimum elevated heliport size provided in relevant performance sections of type-specific Rotorcraft Flight Manual Supplements (RFMS) does not usually correlate to the D-value (overall length) of the largest helicopter intending to use the heliport. Moreover flight testing to establish the minimum RFMS dimension may not have considered, for example, whether an adequate margin of clearance is assured around the helicopter to facilitate safe and expeditious personnel movements; by considering the particular demands of an air ambulance operation to facilitate safe and efficient patient trolley transfer access to and from the helicopter, with medical staff in attendance.
- 3.2 Furthermore it should be borne in mind that in some cases the dimensions published for “Category A” Procedures in RFMS only prescribe an area guaranteed to safely contain the undercarriage of the helicopter based on testing to determine the variation in touchdown location (scatter) during a One Engine Inoperative (OEI) landing; in addition to providing adequate visual references for a normal All- Engines Operating (AEO) landing. So the RFMS may not, in all cases, consider whether the Final Approach and Take-Off Area (FATO) incorporating the Rejected Take-Off Distance (RTOD) is sufficient to ensure the complete containment of the entire helicopter (within a FATO that encapsulates the rotors in addition to the undercarriage) while allowing for scatter in the actual touchdown position of the helicopter - for the case where it is required to reject back onto the surface following an engine failure before TDP.
- 3.3 Taking account of these factors, it is recommended the dimensions for the minimum elevated heliport size provided by the RFMS be treated with caution; assuming, in some cases, it may be insufficient. Therefore it may be prudent to base the design of an elevated heliport (the load-bearing FATO size) on that which approximates to 1.5 times the D-value of the design helicopter e.g. a quadrilateral landing area is provided where each side is approximately 1.5 x the largest overall dimension (D) of the design helicopter.

- 3.4 Where the criteria in this chapter cannot be met in full, the appropriate authority responsible for the approval of the heliport, in conjunction with the helicopter operator(s), may need to consider the imposition of operational restrictions or limitations to compensate for any deviations from criteria. Appendix A addresses a procedure for authorising elevated heliports. A system for the management of compensating restrictions and/or limitations with the production of a 'Heliport Information Plate' to capture the information may be considered - for further guidance see [CAP 437](#), Appendix A.
- 3.5 The criteria in the following table provide information on helicopter size (D-value) and mass (t-value). The overall length of the helicopter on its own does not usually determine the size for a minimum suitable landing area, noting also that the dimensions given below are for information purposes i.e. it is ultimately the heliport designers responsibility to ensure they have all the latest information by type and by variant).

Table 3-1: D-value, 't' Value and other helicopter type criteria

| Type | D-value (m) | Rotor diameter (m) | Max weight (kg) | 't' value |
|----------------------|-------------|--------------------|-----------------|-----------|
| Bolkow Bo 105D | 12.00 | 9.90 | 2400 | 2.4t |
| EC 135 T2+ | 12.20 | 10.20 | 2910 | 2.9t |
| H135 (EC 135 T3) | 12.20 | 10.20 | 2980 | 3.0t |
| MD902 | 12.37 | 10.34 | 3250 | 3.3t |
| Eurocopter AS355 | 12.94 | 10.69 | 2600 | 2.6t |
| Bell 427 | 13.00 | 11.28 | 2971 | 3.0t |
| Agusta A119 | 13.02 | 10.83 | 2720 | 2.7t |
| H145 | 13.03 | 11.00 | 3585 | 3.6t |
| Agusta A109 | 13.05 | 11.00 | 2600 | 2.6t |
| Bell 429 | 13.11 | 10.98 | 3175 | 3.2t |
| BK117D2/EC145T2/H145 | 13.63 | 11.00 | 3650 | 3.7t |
| Dauphin AS365 N2 | 13.68 | 11.93 | 4250 | 4.3t |

| Type | D-value (m) | Rotor diameter (m) | Max weight (kg) | 't' value |
|--------------------|-------------|--------------------|-----------------|-----------|
| Dauphin AS365 N3 | 13.73 | 11.94 | 4300 | 4.3t |
| EC 155B1 | 14.30 | 12.60 | 4850 | 4.9t |
| Leonardo AW 169 | 14.65 | 12.12 | 4800 | 4.8t |
| Sikorsky S76 | 16.00 | 13.40 | 5307 | 5.3t |
| Leonardo AW 139 | 16.63 | 13.80 | 6800 | 6.8t |
| Leonardo AW 189 | 17.60 | 14.60 | 8600 | 8.0t |
| Super Puma AS332L | 18.70 | 15.60 | 8599 | 8.6t |
| Super Puma AS332L2 | 19.50 | 16.20 | 9300 | 9.3t |
| EC 225 | 19.50 | 16.20 | 11000 | 11.0t |
| Sikorsky S92A | 20.88 | 17.17 | 12565 | 12.6t |
| Leonardo AW101 | 22.80 | 18.60 | 15600 | 15.6t |

Note: By including helicopter types in this table it should not be automatically assumed the type (or type variant) has the requisite profiles in its RFM to operate to an elevated heliport. At the time of publication, it is noted that the S92, for example, does not have a profile that would allow it to operate PC1 to an elevated heliport in a congested area.

Heliport design considerations – environmental effects

3.6 The assumption in the following sections is that ideally the elevated heliport design will consist of a separate purpose built structure, usually fabricated from aluminium or steel, rather than a non-purpose built area designed to be an integral part of the building; for example a concrete landing area which forms the top of a roof. Whilst a non-purpose built design is not prohibited, it is clear that this specification for design is incapable of adopting much of the good design practice that follows, such as the recommendation for an air gap or for an overhang of the heliport beyond the edge of the building. Designers should therefore consider the advantages of a purpose built landing area, especially from the perspectives presented in the following sections. Designers of non-

purpose built landing areas are encouraged to read the following sections and apply best practice principles where practical and cost-effective to do so.

- 3.7 The location of an elevated heliport, invariably in a congested hostile environment (see glossary of terms) in a city or town within a hospital complex, even where situated at an elevation that is above all other surrounding buildings, may suffer to some degree from its proximity to tall and bulky structures that may be sited around the heliport. The objective for designers, in examining locations presented in initial feasibility studies, is to create heliport designs that are 'safe and friendly' for helicopter operations and to minimise the environmental effects (mainly aerodynamic, but possibly thermal e.g. chimney structures in proximity to the heliport) which could impact on helicopter operations. Where statutory design parameters cannot be fully achieved it may be necessary for compensating restrictions or limitations to be imposed on helicopter operations which could, in severe cases, for example, lead to a loss of payload when the wind is blowing through a 'turbulent sector'.
- 3.8 Purpose-built helicopter landing areas basically consist of flat plates and so are relatively streamlined structures. In isolation they would present little disturbance to the wind flow, and helicopters would be able to operate safely to them in a more or less undisturbed airflow environment. Difficulties can arise however, because the wind has to deviate around the bulk of a building causing areas of flow distortion and turbulent wakes. The effects fall into three main categories:
- The flow around large items of superstructure that can be present on top of a building such as air conditioning cooling units or lift shafts, have potential to generate turbulence that can affect helicopter operations. Like the building itself, these are bluff bodies which encourage turbulent wake flows to form behind the bodies.
 - Hot gas flows emanating from exhaust outlets such as chimney stacks.
- 3.9 For an elevated heliport on a building it should ideally be located at or above the highest point of the main structure. This will minimise the occurrence of turbulence downwind of adjacent structures that may also be present on the building. However, whilst it is a desirable feature for the heliport to be elevated as high as possible it should be appreciated that for a landing area much in excess of 60 m above ground level the regularity of helicopter operations may be adversely affected in low cloud base conditions. Consequently a trade-off may need to be struck between the height of the heliport above surrounding structures and its absolute height above ground level. It is recommended, where possible that the heliport be located over the corner of a building with as large an overhang as is practicable. In combination with an appropriate elevation and a vital air gap, the overhang will encourage the disturbed airflow to pass under the heliport leaving a relatively clean 'horizontal' airflow above the landing area. It is further recommended that the overhang should be such that the centre of the

heliport is vertically above or outboard of the profile of the building's superstructure. When determining a preference for which edge of the facility the heliport should overhang, the selection of landing area location should minimise the environmental impact due to turbulence, thermal effects etc. This means that generally the landing area should be located so winds from the prevailing directions carry turbulent wakes, and any exhaust plumes, away from the helicopter approach path. To assess if this is likely to be the case it will usually be necessary for designers to overlay the wind direction sectors over the centre of the helideck to establish prevailing wind directions and wind speeds and to assess the likely impact on helicopter operations for a heliport sited at a particular location.

- 3.10 The height of the heliport above surface level, and the presence of an air gap between the landing area and the supporting building, are the most important factors in determining wind flow characteristics in the landing area environment. In combination with an appropriate overhang, an air gap separating the heliport from superstructure beneath will promote beneficial wind flow over the landing area. If no air gap is provided then wind conditions immediately above the landing area are likely to be severe particularly if mounted on top of a large multi- storey building – it is the distortion of the wind flow that is the cause. However, by designing in an air gap typically of between 3m and 6m, this will have the effect of 'smoothing out' distortions in the airflow immediately above the landing area. Heliports mounted on very tall accommodation blocks will require the largest clearances, while those on smaller blocks, and with a very large overhang, will tend to require smaller clearances. For shallow superstructures of three storeys or less, a typical 3m air-gap may not be achievable and a smaller air gap may be sufficient in these cases.
- 3.11 It is important that the air gap is preserved throughout the operational life of the facility, and care should be taken to ensure that the area between the heliport and the superstructure of the building does not become a storage area for bulky items that might hinder the free-flow of air through the gap.

Effects of structure-induced turbulence and temperature rise due to hot exhausts

- 3.12 It is possible that heliports installed on the roofs of buildings located in congested hostile environments will suffer to some degree from their proximity to tall and bulky structures such as adjacent buildings; it is sometimes impractical to site the heliport above every other tall structure. So any tall structure above, or in the vicinity of, the heliport may generate areas of turbulence or sheared flow downwind of the obstruction and thus potentially pose a hazard to the helicopter. The severity of the disturbance will be greater the bluffer the shape and the

broader the obstruction to the flow. The effect reduces with increasing distance downwind from the turbulent source. Ideally a heliport should be located at least 10 structure widths away from any upwind structure which has a potential to generate turbulence. Separations of significantly less than 10 structure widths, may lead to the imposition of operating restrictions in certain wind conditions.

- 3.13 Exhausts, whether or not operating, may present a further source of structure-induced turbulence by forming a physical blockage to the flow and creating a turbulent wake (as well as the potential hazard due to the hot exhaust). As a rule of thumb, to mitigate physical turbulence effects at the heliport it is recommended that a minimum of 10 structure widths be established between the obstruction and the heliport.
- 3.14 Increases in ambient temperature are a potential hazard to helicopters as this will mean less rotor lift and less engine power margin. Rapid temperature changes are a significant hazard as the rate of change of temperature in the plume can cause engine compressor surge or stall to occur (often associated with an audible 'pop') which can result in loss of engine power, damage to engines and/or helicopter components and, ultimately, engine flame out. It is therefore extremely important that helicopters avoid these conditions, or that occurrence of higher than ambient conditions is foreseen, with steps taken to reduce payload to maintain an appropriate performance margin. The heliport should be located so that winds from the prevailing wind directions carry the plume away from the helicopter approach / departure paths.

Note: Except for a case where multiple stacks are sited in close proximity to the landing area, it is unlikely that emissions from a typical source e.g. a chimney stack at a hospital, would have any significant effect on ambient conditions at the heliport. However, guidance is offered in CAA Paper 2008/03 Helideck Design Considerations – Environmental Effects (Section 3.6: Temperature Rise due to Hot Exhausts) for an issue that is more common in the offshore environment. Design teams are encouraged to refer to the relevant section in CAA Paper 2008/03 for more specific guidance.

Heliport design – environmental criteria

Note: The principal tools used to predict the flow field around a heliport are wind tunnel testing and CFD methods which are highlighted in the following sections. For a more in-depth treatment of these issues, when undertaking detailed flow modelling, design teams are encouraged to refer to relevant sections in CAA Paper 2008/03 Helideck Design Considerations – Environmental Effects (Section 5: Methods of Design Assessment) available on the publications section of the CAA website at www.caa.co.uk/publications. Further guidance on airflow testing at onshore elevated heliports is provided in Appendix H.

- 3.15 The design criteria given in the following sections represent the current best information available and may be applied to new facilities, and to significant modifications to existing facilities and/or where operational experience has highlighted potential issues. When considering the volume of airspace to which the following criteria apply, designers should consider the airspace up to a height above heliport level which takes into consideration the requirement to accommodate helicopter landing and take-off decision points or committal points. This is considered to be a height above the heliport corresponding to 30 feet (9.14m) plus wheels-to-rotor height plus one rotor diameter.
- 3.16 As a general rule in respect to turbulence, a limit on the standard deviation of the vertical airflow velocity of 1.75 m/s should not be exceeded. Where these criteria are significantly exceeded (i.e. where the limit exceeds 2.4 m/s), there is the possibility that operational restrictions will be necessary. Facilities where there is a likelihood of exceeding the criteria should be subjected to appropriate testing e.g. a scale model is placed in a wind tunnel, or by CFD analysis, to establish the wind environment in which helicopters will be expected to operate.
- 3.17 Unless there are no significant heat sources in the vicinity of the heliport, designers should consider commissioning a survey of ambient temperature rise based on a Gaussian Dispersion model and supported by wind tunnel testing or CFD analysis. Where the results of such modelling and/or testing indicate there may be a rise in air temperature of more than 2 degrees Celsius averaged over a 3-second time interval, there is the possibility that operational limitations and/or restrictions may need to be applied .

Heliport structural design

- 3.18 The helicopter landing area and any parking areas provided should be of sufficient size and strength and laid out so as to accommodate the heaviest and largest helicopter requiring to use the facility (referred to as the design helicopter). The structure should incorporate a load bearing area designed to resist dynamic loads without disproportionate consequences from the impact of

an emergency landing anywhere within the area bounded by the TLOF perimeter markings (see Chapter 4).

- 3.19 The helicopter landing area and its supporting structure should be fabricated from steel, aluminium alloy or other suitable materials designed and fabricated to suitable standards. Where differing materials are to be used in near contact, the detailing of the connections should be such as to avoid the incidence of galvanic corrosion.
- 3.20 Both the ultimate limit states (ULS) and the serviceability limit states (SLS) should be assessed. The structure should be designed for the SLS and ULS conditions appropriate to the structural component being considered as follows:
- For deck plate and stiffeners –
 - ULS under all conditions;
 - SLS for permanent deflection following an emergency landing.
 - For helicopter landing area supporting structure –
 - ULS under all conditions;
 - SLS.
- 3.21 The supporting structure, deck plates and stringers should be designed to resist the effects of local wheel or skid actions acting in combination with other permanent, variable and environmental actions. Helicopters should be assumed to be located within the TLOF perimeter markings in such positions that maximise the internal forces in the component being considered. Deck plates and stiffeners should be designed to limit the permanent deflection (deformation) under helicopter emergency landing actions to no more than 2.5% of the clear width of the plates between supports. Webs of stiffeners should be assessed locally under wheels or skids and at the supports, so as not to fail under landing gear actions due to emergency landings. Tubular structural components forming part of the supporting structure should be checked for vortex-induced vibrations due to wind.

Note: For the purposes of the following sections it may be assumed that single main rotor helicopters will land on the wheel or wheels of two landing gear or on both skids, where skid fitted helicopters are in use. The resulting loads should be distributed between two main undercarriages. Where advantageous, a tyre contact area may be assumed within the manufacturer's specification.

Case A – helicopter landing situation

A heliport should be designed to withstand all the forces likely to act when a helicopter lands. The load and load combinations to be considered should include:

a) **Dynamic load due to impact landing**

This should cover both a heavy normal landing and an emergency landing. For the former an impact load of 1.5 x MTOM of the design helicopter should be used while

for an emergency landing an impact load of $2.5 \times \text{MTOM}$ should be applied in any position on the landing area together with the combined effects of b) to g) inclusive. Normally the emergency landing case will govern the design of the structure.

b) Sympathetic response of the landing platform

After considering the design of the heliport structures supporting beams and columns and the heliport structure and the characteristics of the design helicopter, the dynamic load (see a) above) should be increased by a suitable structural response factor (SRF) to take account of the sympathetic response of the helicopter landing area structure. The factor to be applied for the design of the helicopter landing area framing depends on the natural frequency of the deck structure. Unless specific values are available based upon particular undercarriage behaviour and deck frequency, a minimum SRF of 1.3 should be assumed.

c) Overall superimposed load on the loading platform

To allow for any appendages that may be present on the deck surface, such as heliport lighting, in addition to the wheel loads, an allowance of 0.5 kN/m^2 should be applied over the whole area of the heliport.

d) Lateral load on landing platform supports

The helicopter landing platform and its supports should be designed to resist concentrated horizontal imposed actions equivalent to $0.5 \times$ maximum take-off mass (MTOM) of the design helicopter, distributed between the undercarriages in proportion to the vertical loading and applied in the horizontal direction that will produce the most severe loading for the structural component being considered.

e) Dead load of structural members

This is the normal gravity load on the element being considered.

f) Environmental actions on the heliport

Wind actions on the heliport structure should be applied in the direction, which together with the horizontal impact actions produce the most severe load case for the component considered. The wind speed to be considered should be that restricting normal (non-emergency) helicopter operations at the landing area. Any vertical up and down action on the heliport structure due to the passage of wind over and under the heliport should be considered.

g) Punching shear

Where helicopters with wheeled undercarriages are operated, a check should be made for the punching shear from a wheel of the landing gear with a contact area of $65 \times 10^3 \text{ mm}^2$ acting in any probable location. Particular attention to detailing should be taken at the junction of the supports and the helicopter landing area.

Case B – helicopter at rest situation

In addition to Case A above, a heliport should be designed to withstand all the applied forces that could result from a helicopter at rest; the following loads should be taken into account:

a) Imposed load from helicopter at rest

All parts of the heliport should be assumed to be accessible to helicopters, including any parking areas and should be designed to resist an imposed (static) load equal to the MTOM of the design helicopter. This load should be distributed between all the landing gear and applied in any position so as to produce the most severe loading on each element considered.

b) Overall superimposed load

To allow for personnel, freight, refuelling equipment and other traffic, snow and ice, and rotor downwash effects etc, a general area-imposed action of 2.0kN/m² should be added to the whole area of the heliport.

c) Horizontal actions from a tied down helicopter including wind actions

Each tie-down should be designed to resist the calculated proportion of the total wind action on the design helicopter imposed by a storm wind with a minimum one-year return period.

d) Dead load

This is the normal gravity load on the element being considered and should be regarded to act simultaneously in combination with a) and b). Consideration should also be given to the additional wind loading from any parked or secured helicopter (see also e) (1) below).

e) Environmental actions

Wind loading – the 100-year return period wind actions on the helicopter landing area structure should be applied in the direction which, together with the imposed lateral loading, produces the most severe load condition on each structural element being considered.

Size obstacle protected surfaces / environment

- 3.22 According to EASA Requirements for Air Operators, Part-OPS, Annex IV Part-CAT (Sub Part C Performance and Operating Limitations (POL)) and Annex VI Part-SPA (Sub Part J Helicopter Emergency Medical Service operations (HEMS)), in Europe flights conducted to elevated heliports in congested areas have to be undertaken by helicopters operated in performance class 1 (PC1) (see Chapter 2 for further discussion).

- 3.23 PC1 operating rules require that the size of the helicopter landing area incorporates a Rejected Take-Off Area (RTOA), into which the helicopter can safely reject (with assurance of full containment including rotors), in the event of an engine failure occurring during the early stages of the take-off procedure. The size of the Final Approach and Take-Off Area (FATO) incorporating the RTOA will vary from type to type (and sometimes even between type variants). Taking into account also the need for safe and efficient ground operations (e.g. allowing effective patient trolley transfers from the helicopter to a dedicated lift), the minimum landing area will rarely, if ever, be as small as for an offshore helideck at 1 times the overall length of the helicopter – D - (note: helicopter's operating to offshore helidecks are not required to meet the same stringent PC1 rules). For the reasons already discussed in Section 1 of this chapter, and in Chapter 2, the dimensions published in the RFMS should be treated with caution when considering the minimum acceptable dimensions for a landing area (FATO).
- 3.24 At the earliest design / concept stage designers should consider what type (or types) may be required to operate at a particular heliport throughout the proposed operating life of the facility. Exceptionally, consideration of the size of the heliport may be based on operations by a single type, but much more likely will need to accommodate a range of twin-engine helicopters operating a number of different roles including, but not limited to: Police, HEMS, Air Ambulance, other emergency services and Search and Rescue (SAR). In this event the task of the heliport designer becomes one of identifying the most critical type in respect to the dimensional design aspects of the heliport and to then assume this is the 'design helicopter', in the knowledge that other types, having an approved class 1 profile in the RFMS, should also be able to operate safely and legally to the heliport; provided the other critical design consideration for accommodating the maximum take-off mass (MTOM) of the heaviest helicopter intending to operate to the heliport is also satisfied.
- 3.25 Chapter 3, Table 1 provides the basic characteristics for a range of small, medium and large civil helicopters known to be capable of operating under specified conditions in performance class 1 to elevated heliports in congested areas (but see additional 'exceptions' note below Table 1). It is re-emphasised that the D-value of the helicopter does not usually define the minimum dimensions of the landing area and it is the responsibility of the heliport designer to collate information from all relevant sources to determine the minimum dimensions for a particular elevated heliport. In general a heliport which is equal to, or is greater than, 1.5 times the D-value of the design helicopter will usually be sufficiently large to accommodate all civil helicopters, including those that are smaller than the design helicopter.
- 3.26 The helicopter landing area (the FATO) should be surrounded by a safety area (SA) which need not necessarily be a solid surface. The safety area should extend outwards from the periphery of the landing area for a distance of at least

3m or 0.25D for the largest helicopter the heliport is intended to serve, whichever is greater, subject to the FATO plus safety area achieving a minimum overall dimension of 2D for each external side based on a quadrilateral. Where applicable, the surface should be prepared in a manner to prevent flying debris caused by rotor downwash.

- 3.27 No fixed raised object should be permitted around the periphery of the landing area except for objects which because of their safety function are required to be located there. In consideration of the above, only the following essential objects may exceed the height of the landing area, but should not do so by more than 25cm:
- The guttering (associated with the requirements of paragraph 5.2);
 - The perimeter lighting required by Chapter 4;
 - All handrails, which are incapable of complete retraction or lowering for helicopter operations, including handrails provided for an access ramp;
 - Where provided, a Fixed Monitor System (FMS) permitted as an alternative means of compliance to a Deck Integrated Fire-Fighting System (DIFFS).
- 3.28 The surface of the safety area, when a solid, should not exceed an upward slope of 4 per cent outwards from the edge of the landing area and should be continuous with the edge of the landing area. There should be a protected side slope rising at 45 degrees from the edge of the safety area to a distance of 10m, whose surface should not be penetrated by obstacles, except when obstacles are located to one side of the landing area only, in which case they may be permitted to penetrate the surface of the side slope.
- 3.29 Objects whose function requires them to be located on the surface of the landing area such as, where provided, the TD/PM Circle and Cross “chevron” marking lighting prescribed by Chapter 4 and detailed in Appendix D, should not exceed the surface of the landing area by more than 2.5 cm. Such objects should only be present if they do not pose a hazard to helicopter operations.
- 3.30 The assumption is made that an elevated heliport will not usually be designed with a system of helicopter ground or air taxiways feeding to one or more stands for parked helicopters. However, provision for such arrangements is accounted for in ICAO Annex 14 Volume II and may be considered within the overall design of an elevated heliport. The provisions of Annex 14 Volume II, including those relating to the physical characteristics of a surface level heliport and the marking and lighting of taxiways and stands, are reproduced for convenience in a stand-alone Appendix, E. Advice and guidance on the interpretation of these provisions in practice may be sought from CAA Flight Operations (Helicopters).
- 3.31 An elevated heliport should ideally be provided with approach and take-off climb surfaces that allow for an approach or take-off to always be conducted into wind (i.e. to assure this in all wind conditions, an obstacle protected surface would

need to be provided throughout 360 degrees). A 360 degree approach and take-off / departure sector will minimise the likelihood for operational restrictions becoming necessary in particular conditions (combinations of wind speed / direction). However, due to the nature of UK hospitals, invariably situated in congested areas, unless the heliport is situated at the highest point on the estate, it is often not possible to provide obstacle limitation surfaces that are unfringed throughout 360 degrees given there is also a need to consider obstacles out to a distance of several kilometres from the heliport. In the circumstances, as a minimum, a heliport should be provided with at least two approach and take-off climb surfaces, ideally separated by 180 degrees, but by not less than 135 degrees, to avoid downwind conditions, minimise cross-wind conditions and permit for a baulked landing (see illustrations of obstacle limitation surfaces in figures 1 and 2 below). The slopes for the obstacle limitation surfaces should not be greater than, and the other dimensions not less than, those specified for Slope Design Category A in table 3 (below).

Figure 4-1: Obstacle limitation surfaces - take-off climb & approach surface

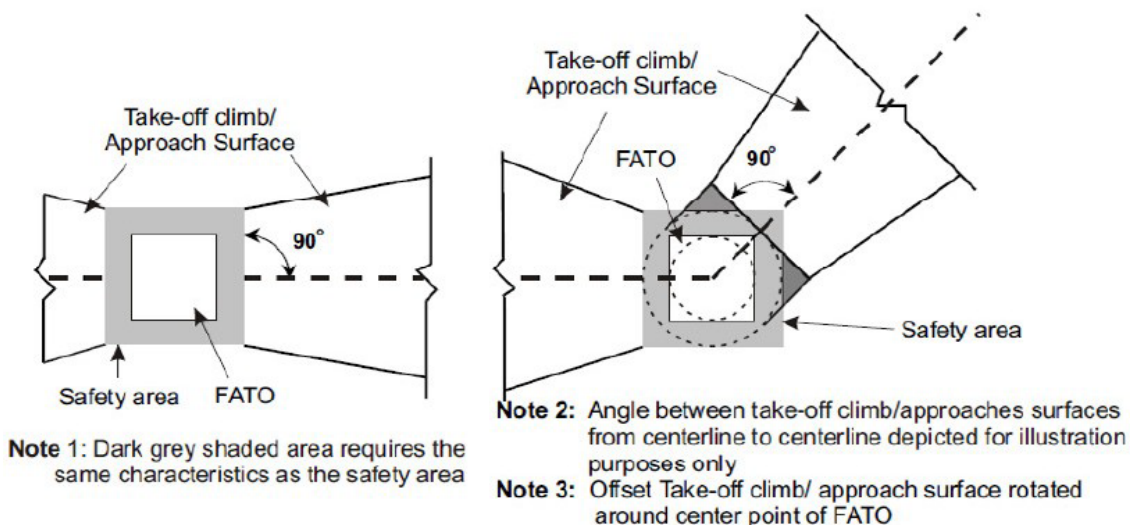

Figure 4-2: Take-off climb / approach surface width

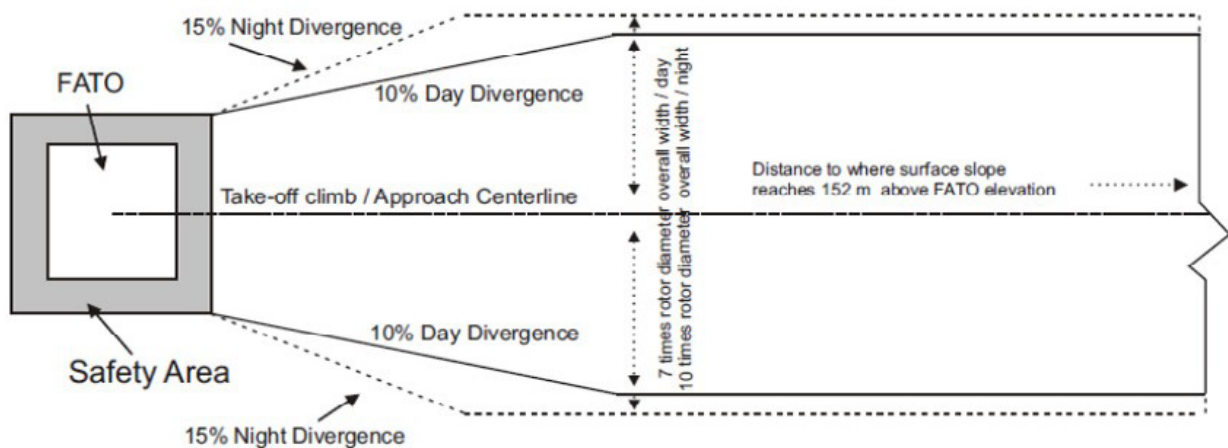

Table 4-1: Dimensions and slopes of obstacle limitation surfaces for all visual FATOs

| Surface and dimensions | Slope design categories | | |
|--|--|----------------------|----------------------|
| | A | B | C |
| Approach and take-off climb surface | | | |
| Length of inner edge | Width of safety area | Width of safety area | Width of safety area |
| Location of inner edge | Safety area boundary (clearway boundary if provided) | Safety area boundary | Safety area boundary |
| Divergence (1 st and 2 nd section) | | | |
| Day use only | 10% | 10% | 10% |
| Night use | 15% | 15% | 15% |
| First section | | | |
| Length | 3386m | 245m | 1220m |
| Slope | 4.5% (1:22.2) | 8% (1:12.5) | 12.5% (1:8) |
| Outer width | b) | N/A | b) |
| Second section | | | |
| Length | N/A | 830m | N/A |
| Slope | N/A | 16% (1:6.25) | N/A |
| Outer width | N/A | b) | N/A |
| Total length from inner edge a) | 3386m | 1075m | 1220m |
| Transitional surface (FATOs with a PinS approach procedure with a VSS) | | | |
| Slope | 50% (1:2) | 50% (1:2) | 50% (1:2) |
| Height | 45m | 45m | 45m |

- a) The approach and take-off climb surface lengths of 3386m (for slope A) and 1075m and 1220m (for slopes B and C respectively) bring the helicopter to 152m (500') above the elevation of the heliport.
- b) 7 rotor diameters overall width for day operations or 10 rotor diameters overall width for night operations.

Note: The slope design categories in Table 4-1 represent minimum design slope angles and not operational slopes. Slope category "A" generally corresponds

with helicopters operated in performance class 1; slope category “B” generally corresponds with helicopters operated in performance class 3; and slope category “C” generally corresponds to helicopters operated in performance class 2. For the purpose of this CAP, where helicopters are required to operate in PC1 to elevated heliports in congested areas, the designer need be concerned only with the characteristics of slope category “A”. Slope category “B” and “C” design slopes are not applicable in these cases.

3.32 For helicopter operations conducted in performance class 1 applying the 4.5% slope “A” criteria, the length of the inner edge of the take-off climb and approach surface equates to the width of the safety area, located on the safety area boundary at the elevation of the helicopter landing area. For operations by day, two side edges are provided originating at the ends of the inner edge diverging uniformly at a rate of 10% until they reach an overall width of 7 x rotor diameter (RD) of the largest helicopter authorised to operate to the heliport. From this point the outer edge continues horizontal and perpendicular to the centreline of the approach and take-off climb surface out to a distance from the inner edge where the surface reaches a height of 152m (500') above the elevation of the inner edge – on level ground this is an overall length of 3386m.

3.33 For operations by night, the two side edges originating at the ends of the inner edge diverge uniformly at a rate of 15% until they reach an overall width of 10 x rotor diameter (RD) of the largest helicopter authorised to operate to the heliport. From this point the outer edge continues horizontal and perpendicular to the centreline of the approach and take-off climb surface out to a distance from the inner edge to a distance where the surface reaches a height of 152m (500') above the elevation of the inner edge – on level ground this is an overall length of 3386m.

Note: For an elevated heliport without a Point in Space (PinS) approach incorporating a visual segment surface (VSS) there is no requirement to provide transitional (side) surfaces (however, attention is drawn to paragraph 3.52 for restrictions where obstacles are present on both sides of the heliport).

3.34 For operations conducted in PC1 using approved vertical / rearward take-off and landing profiles, there is a facility for heliports to raise the origin of the 4.5% inclined plane for the approach and/or take-off climb surface directly above the landing area. This is depicted in a generic example in Figure 3 (below) and in Appendix C in an illustration of obstacle clearances in the back-up area.

Figure 4-3: Example of raised inclined plane during operations in performance class 1

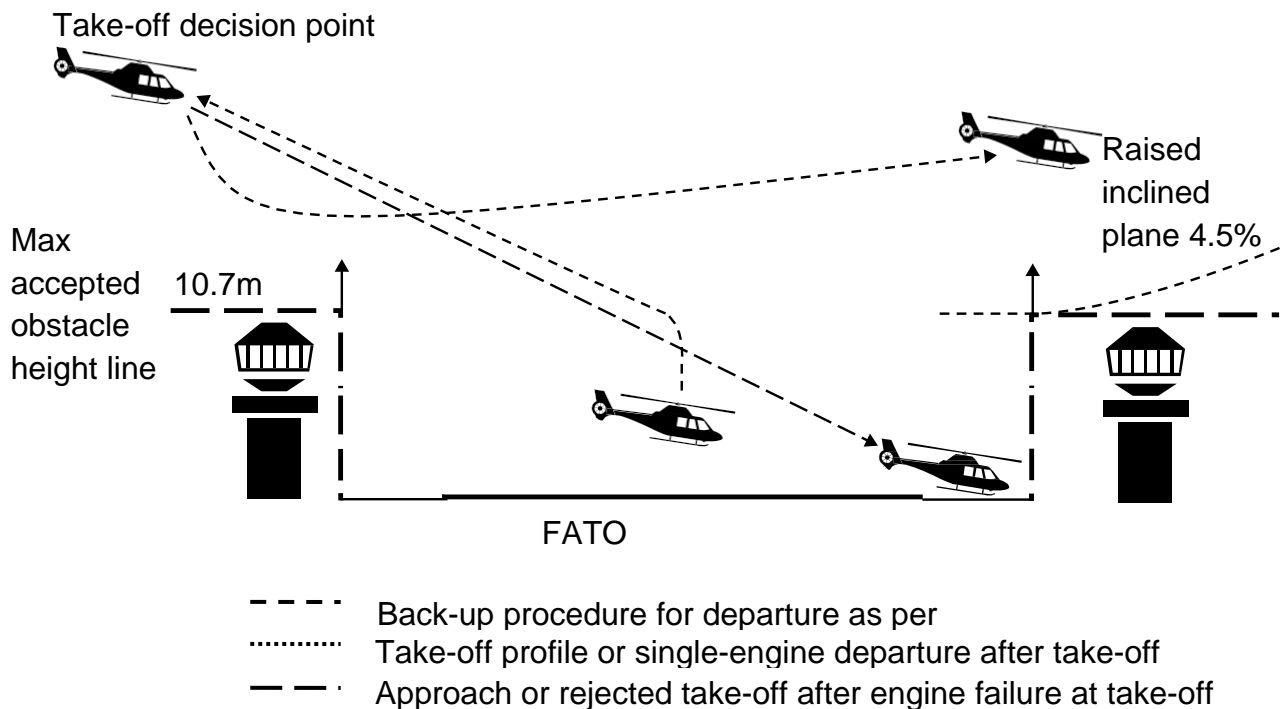

Note 1: This example diagram does not represent any specific profile, technique or helicopter type and is intended to show a generic example. An approach profile and a back-up procedure for departure profile are depicted. Specific manufacturers operations in performance class 1 may be represented differently in the specific Helicopter Flight Manual. Annex 6, Part 3, Attachment A provides back-up procedures that may be useful for operations in performance class 1.

Note 2: The approach / landing profile may not be the reverse of the take-off profile.

Note 3: Additional obstacle assessment might be required in the area where the back-up procedure is intended. Helicopter performance and the Helicopter Flight Manual limitations will determine the extent of the assessment required.

3.35 The characteristics of the take-off climb and approach surfaces are based on a 4.5% slope which provides an obstacle limitation surface that may only be penetrated by objects if the results of an aeronautical study have reviewed the associated risks and mitigation measures. However, any identified objects may limit the operation. Where practicable existing objects above the prescribed surfaces should be removed, except when the object is shielded by an immovable object or if the results of the aeronautical study determine that the object would not adversely affect the safety or regularity of helicopter operations. New objects, or extensions to existing immovable objects, should not be permitted above the surfaces except when assessed and approved by an appropriate aeronautical study.

- 3.36 In the case of an approach or a take-off climb surface involving a turn, the surface should be a complex surface containing the horizontal normal's to the centreline and the slope of the centreline should be the same as for a straight approach or take-off and climb surface. In the case of an approach or take-off climb surface involving a turn, the surface should not contain more than one curved portion. The curved portion provided should be the sum of the radius of arc defining the centreline and the straight portion originating at the inner edge should not be less than 575m. Additionally any variation in the direction of the centreline should be designed so as not to necessitate a turn radius less than 270m. See Figure 4.

Figure 4-4: Curved approach and take off climb surface for all FATOs

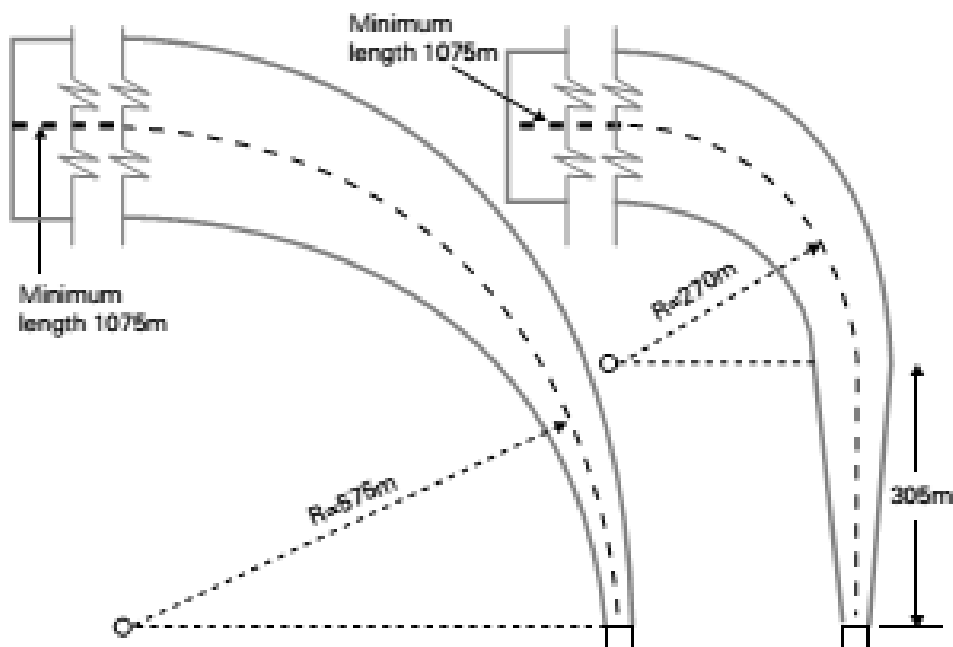

Note 1: Any combination of curve and straight portion may be established using the following formula: $S+R>575m$ and $R>270$ where $S=305m$, where S is the length of the straight portion and R is the radius of turn. Any combination $> 575m$ will work.

Note 2: The minimum length of the centre line of the curve and straight portion is 1075m but may be longer depending upon the slope used. See table 4.1 for longer lengths.

Note 3: Helicopter take-off performance is reduced in a curve and as such a straight portion along the take-off surface prior to the start of the curve should be considered to allow for acceleration.

Surface

Note: Where a heliport is constructed in the form of a grating, e.g. where a passive fire-retarding system is selected (see Chapter 5), the design of the landing area surface should ensure that ground effect (promotion of a beneficial ground cushion) is not reduced for any of the types likely to use the heliport.

- 3.37 The landing area, including all markings on the surface of the touchdown area (see Chapter 4, figures 6 & 7), should be provided with a non-slip finish. It is important that adequate friction exists over the entire surface of the heliport (inside the touchdown / positioning marking (TD/PM) circle primarily to benefit the helicopter but also for safe personnel / trolley transfer movements, and outside the TD/PM circle for safe personnel / trolley transfer movements), in all directions and for worst case conditions, i.e. when the deck is wet. Over-painting surfaces with material other than non-slip coatings will likely reduce surface friction. Suitable non-slip surface friction paint is available commercially and should be used.
- 3.38 Every landing area should be equipped with adequate surface drainage arrangements and a free-flowing collection system that will quickly and safely direct any rainwater, fire fighting media and/or fuel spillage away from the heliport surface to a safe place. Heliports, with a solid plate surface, should be cambered (or laid to a fall) to approximately, and not less than, 1:100. Any distortion of the heliport surface due to, for example, loads from a helicopter at rest should not modify the landing area drainage system to the extent of allowing spilled fuel to remain on the surface. A system of guttering or a slightly raised kerb should be provided around the perimeter to prevent spilled fuel from falling on to other parts of the installation or the building beneath; any spillage should be conducted to an appropriate drainage system. The capacity of the drainage system should be sufficient to contain the maximum likely spillage of fuel on the heliport and be adequate to cope with the largest foreseeable rainfall rate. The calculation of the amount of spillage to be contained should be based on an analysis of helicopter type, fuel capacity, and typical fuel loads. The design of the drainage system should preclude blockage by debris and/or the drainage system should be regularly inspected or tested to ensure that it remains clear. The landing area should be properly sealed so that all spillages will be collected by the drainage system.
- 3.39 The touchdown area should be shown to achieve an overall average surface friction coefficient of not less than 0.60μ and no two adjacent 1m^2 areas should achieve less than 0.60μ as determined by an acceptable test method (see notes below). The use of a landing area net to compensate for insufficient friction is disallowed at hospital landing sites and other sites operated to by skid fitted helicopter types due to the possibility of skids becoming entangled in the net. In

addition, patient trolley access right up to the helicopter will be required at all times at a hospital heliport, which would be compromised by the presence of a landing net. The area outside the TD/PM circle should be shown to achieve an overall average surface friction coefficient of not less than 0.5μ and no two adjacent 1m^2 areas should achieve less than 0.5μ as determined by an acceptable test method (see notes below). It is considered that this value of friction coefficient should provide for the safe movement of personnel, including trolley transfers.

- 3.40 The heliport operator should ensure that the heliport is kept free from oil, grease, ice, snow, excessive surface water or any other contaminant that could degrade the surface friction properties (see also Chapter 6). Assurance should be provided to the helicopter operator that procedures are in place for the removal of contaminants prior to operations. Depending on the type of surface, the average surface friction of the heliport may need to be re-validated at regular intervals to verify a continuing fitness for purpose (a scheme is described in CAP 437).

Note 1: A review of helideck friction measurement techniques has concluded that the test method to be employed for helidecks and heliports, except for those having profiled surfaces, should utilise a friction measuring device that employs the braked wheel technique; is able to control the wetness of the deck during testing; includes electronic data collection, storage and processing; and allows the whole of the deck surface to be covered to a resolution of not less than 1m^2 . An example helideck friction survey test protocol is published in CAP 437, Appendix G.

For heliports with profiled surfaces (whether painted or not), wheeled testers are deemed to be unsuitable as they can only measure friction in the rolling direction of the wheel. In these cases, testing should be conducted in accordance with CAP 437, paragraph 3.43 for heliports commissioned on or after 1 January 2017 and in accordance with CAP 437, paragraph 3.44 for heliports commissioned before 1 January 2017.

Note 2: Friction testing of the yellow TD/PM circle and the area outside the white Cross marking is not required where TD/PM and Cross marking “chevrons” are fitted. The light fittings themselves occupy a significant proportion of the area and are required to be provided with a 0.60μ (minimum) finish. Testing of the remaining small / narrow areas of the paint markings would be impractical, especially around the TD/PM circle as wheeled testers are normally be maintained on a straight course. In addition, the light fittings have been found to disturb friction tester readings as the test wheel passes over their raised profiles.

Helicopter tie-down points

- 3.41 Sufficient flush fitting (when not in use) tie-down points should be provided for securing the maximum sized helicopter for which the heliport is designed. Tie-down points should be located and be of such strength and construction to secure the helicopter when subjected to weather conditions pertinent to the heliport operation.
- 3.42 Tie-down points should be compatible with the dimensions of tie-down strop attachments. Tie-down points and strops should be of such strength and construction so as to secure the helicopter when subjected to weather conditions pertinent to the heliport design considerations. The maximum bar diameter of a tie-down point should match the strop hook dimension of the tie-down strops carried in most helicopters. Advice on recommended safe working load requirements for strop / ring arrangements for specific helicopter types can be obtained from the helicopter operator(s).
- 3.43 An example of a suitable tie-down configuration is shown at Figure 5. The helicopter operator can provide guidance on the configuration of the tie-down points for specific helicopter types.

Figure 4-5: Example of suitable tie-down configuration

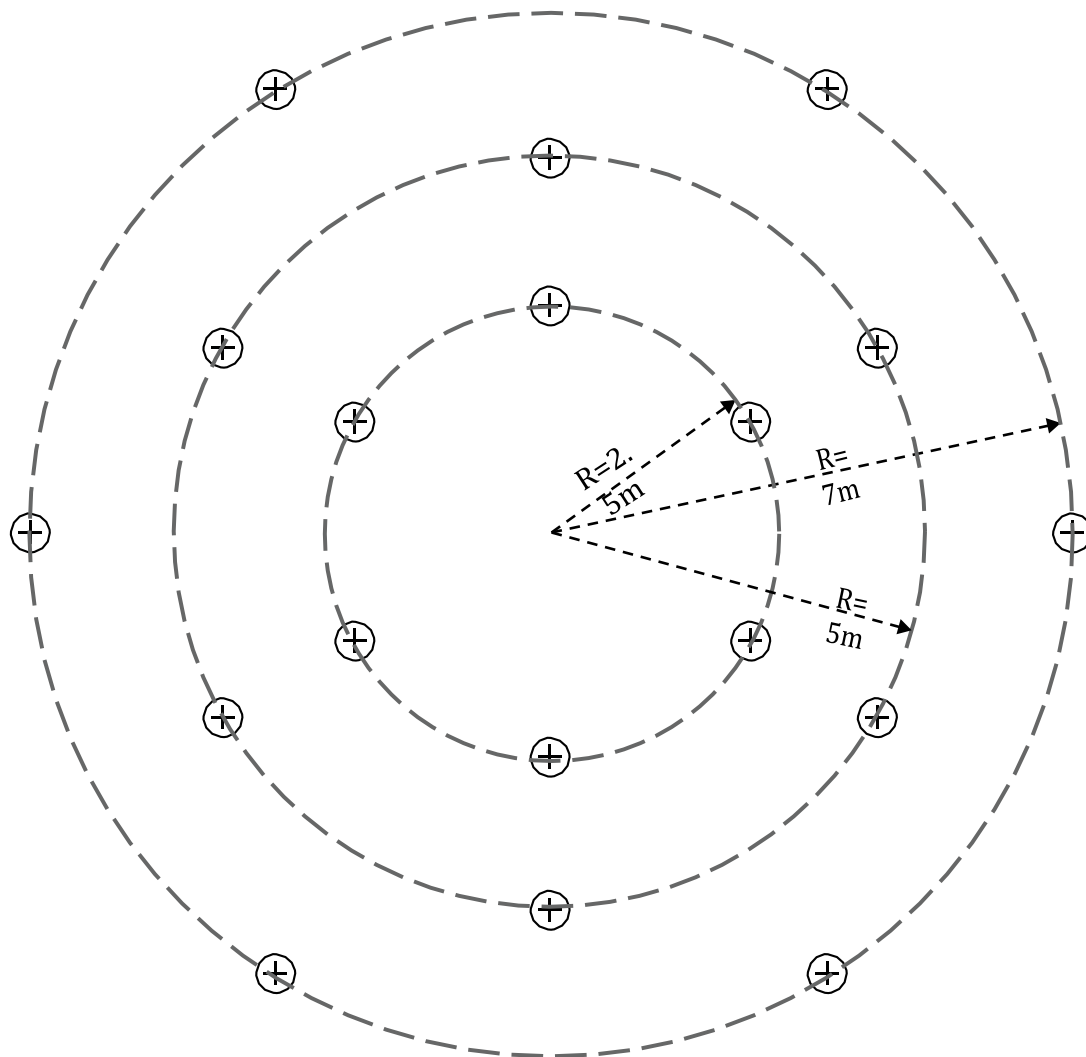

Note 1: The tie-down configuration should be based on the centre of the TD/PM circle.

Note 2: Additional tie-downs will be required for a parking area.

Note 3: The outer circle is not required for helicopters with D-values of less than 22.2m.

Safety net

3.44 Safety nets for personnel protection should be installed around the landing area, in the safety area, except where adequate structural protection against falls exists. The netting used should be of a flexible nature, with the inboard edge fastened just below the edge of the landing area. The net itself should extend at least 1.5 metres in the horizontal plane and be arranged so that the outboard edge does not exceed the level of the landing area and be angled so that it has an upward and outward slope of approximately 10°.

3.45 A safety net designed to meet these criteria should 'contain' personnel falling into it and should not act as a trampoline. Where lateral or longitudinal centre bars are provided to strengthen the net structure they should be arranged and constructed to avoid causing serious injury to persons falling on to them. The ideal design should produce a 'hammock' effect which should securely contain a body falling, rolling or jumping into it, without serious injury. When considering the securing of the net to the structure and the materials used, care should be taken that each segment is fit for purpose. Polypropylene deteriorates over time; various wire meshes have been shown to be suitable if properly installed.

Note 1: It is not within the scope or purpose of this CAP to provide detailed guidance for the design, fabrication and testing of perimeter nets. These specific issues are addressed for netting systems on offshore helidecks (and are equally applicable for onshore heliports) in the Oil and Gas UK Guidelines for the Management of Aviation Operations' Issue 6 April 2011.

Note 2: Perimeter nets may incorporate a hinge arrangement to facilitate the removal of sacrificial panels for testing.

Access points – ramps and stairs

3.46 For reasons of safety it is necessary to ensure that embarking and disembarking medical teams and patients are not required to pass around the helicopter tail rotor, or around the nose of a helicopter having a low profile main rotor, if a 'rotors-running turn-round' is conducted. Many helicopters have personnel access on one side only and the landing orientation of the helicopter in relation to access points is therefore important.

3.47 There should be a minimum of two access / egress routes to and from the heliport preferably diametrically opposite one another. The most efficient, and fail safe, means of moving patients on trolleys to and from an elevated heliport is by use of a short flat ramp linking the heliport to a dedicated lift transfer, from rooftop level, straight down to ED).

3.48 Where a ramp 10m or longer is employed to transfer a patient from heliport level to a lower level lift, the maximum gradient should ideally not exceed 1:20 - or flatter wherever possible. For short sections of ramps a steeper gradient may be acceptable subject to a risk assessment. The ramp design may need to incorporate a waiting area approximately 2m below the level of the heliport on which specialist personnel can congregate with their equipment to observe the arrival and departure of helicopters. It is preferable for the ramp design to run away from the heliport to put distance between congregating personnel and the potential crash location, and also to provide a walkway around the building below heliport level should the need arise to approach the heliport from the opposite side. Ideally two ramps are preferable, but one ramp and one staircase

may be deemed acceptable where both are wide enough for a trolley and/or for a stretcher with attendants. The layout of the ramp / staircase arrangement should be optimised to ensure that, in the event of an accident or incident on the heliport, personnel are able to escape upwind of the helicopter. Adequacy of the emergency escape arrangements from the heliport should be included in any evacuation, escape and rescue analysis for the heliport; the analysis may require that a third escape route be provided.

Note: For discussion on the use of ramps (and the preferred use of dedicated lifts at rooftop level) in the context of the needs of the patient, see Chapter 1.

- 3.49 If a Fixed Monitor System (FMS) is installed in preference to a Deck Integrated Fire-Fighting System (DIFFS) – see Chapter 5 - and foam monitors are co-located on access platforms, care should be taken to ensure that no monitor is so close to an egress point as to risk causing injury to escaping personnel due to the operation of the monitor in an emergency situation.
- 3.50 Where handrails associated with heliport access / escape points exceed the height limitations given in paragraph 3.27 they should be made retractable, collapsible or removable. When retracted or collapsed the rails should not impede safe access / egress. Handrails which are retractable or collapsible may need to be painted in a contrasting colour scheme (see Chapter 4). Procedures should be put in place to retract collapse or remove them prior to a helicopter arrival. Once the helicopter has landed, and the air crew have indicated that passenger movement may commence, the handrails should be raised and locked into position. The handrails should be retracted, collapsed or removed again prior to the helicopter taking off.

Lifts

- 3.51 On a large roof it should be possible to provide a dedicated lift in close proximity for access directly from heliport level to the ED facility. However, if this option is to be realised it is imperative that the lift housing does not compromise the obstacle limitation surfaces established for the heliport by creating a dominant obstacle above the level of the landing area which penetrates an established obstacle limitation surface (a very large structure could also be a source of structure-induced turbulence in addition to compromising helicopter approach and take-off corridors). For this reason the lift-housing should be located outside the 2D safety area, where, provided there are obstructions above heliport level on one side only, there are no formal obstacle limitation surfaces for a visual heliport.

Note: In considering the siting of a lift above heliport level, designers should avoid locations which impact on the preferred approach and/or take-off directions i.e. where the prevailing wind is south-westerly, and airways are

separated by 180 degrees, it is inadvisable to site a lift, rising above heliport level, outside the safety area, in the quadrant west through to south or north through to east.

- 3.52 It is important that any dedicated lift servicing the heliport is immediately available to the heliport 'on demand'. Every effort should be made to install a dedicated lift for heliport use only, but if it is not possible to provide a dedicated lift solely for heliport use, then the next best option will be to commandeer a public lift (prior to the helicopter touching down) and to isolate it for immediate heliport use. In this case an override facility would be required to allow authorised personnel to take control of the lift when the heliport is in use, prior to the helicopter landing.

Note 1: The public should not be able to use the lift to access the heliport areas. Where lift transfer to ED is the preferred option, the risk of possible lift failure at a critical moment should be considered.

Note 2: Where trolley transfer is used a covered location should be identified close to the heliport where a dedicated patient trolley can be stored securely, so one is always available.

Helicopter base facilities for a helicopter emergency medical services (HEMS) operation

- 3.53 Air ambulance helicopters are normally based at a location central to the area they cover, and are not likely to be based at a particular hospital. However, some city-centre hospitals may regard a HEMS helicopter as integral to their pre-hospital care system such that they may require a HEMS helicopter to be based at the hospital either permanently or during operational hours only; in which case additional crew facilities should be considered.
- 3.54 To service a HEMS heliport, helicopter bases require an operations room, a crew room and various support facilities. If the base is to be used for the regular training of paramedics and doctors in the medical and aviation aspects of HEMS operations, additional offices, training rooms and facilities would need to be considered.
- 3.55 For permanently based helicopters, an aircraft hangar should improve the security and serviceability of the helicopter, and provide an environment for minor technical tasks to be undertaken on site. The effect of any hangar arrangement on obstacle protected surfaces and any associated turbulence issues should be fully assessed before committing to the project.
- 3.56 Where RFF personnel are permanently based at a HEMS heliport, there should be provided a heated covered area close to the heliport where personnel can store, layout and don their Personal Protective Equipment (PPE).

Chapter 4

Visual aids

General

- 4.1 A heliport intended for use by day needs only to display appropriate markings, while a heliport intended for use at night will need to display appropriate aeronautical lighting in addition to appropriate markings. The markings described in this chapter are based on specifications included in Annex 14, Volume II (4th Edition, July 2013) and, for heliport lighting, are developed based around the Specification for a helideck lighting scheme published in Appendix C in CAP 437, adapted to support onshore heliport operations conducted by night in visual meteorological conditions (VMC).

Wind direction indicator(s)

- 4.2 The purpose of a wind direction indicator is to display the wind direction and provide an indication of wind speed at the heliport. A facility should be equipped with at least one wind direction indicator to provide a visual indication of the wind conditions prevailing at the heliport during helicopter operations.
- 4.3 The location of the wind direction indicator should be in an undisturbed air stream avoiding any effects caused by nearby structures (see also Section 2 in Chapter 3), and unaffected by rotor downwash from helicopters. The location of the wind direction indicator should not compromise the established obstacle protected surfaces (see Chapter 3). Typically, the primary wind direction indicator will consist of a coloured windsock.
- 4.4 The wind sock should be easy visible to the pilot on the approach (at a height of at least 650ft (200m) on approach to the hover, when landing on the surface of the heliport, and prior to take-off. Where these operational objectives cannot be fully achieved by the use of a single windsock, consideration should be given to siting a second wind sock in the vicinity of the heliport, which may be used to indicate a specific difference between the local wind over the landing area and the free stream wind (which the pilot will need to consider for the approach).
- 4.5 A windsock should be a truncated cone made of a suitable lightweight fabric with a minimum length of at least 1.2m, a diameter at the larger end of at least 0.3m and a diameter at the smaller end of at least 0.15m. The colour should provide a good contrast with the operational background. Ideally a single colour windsock, preferably orange, should be selected. However, where a combination of colours

is found to provide better conspicuity against a changeable operating background, orange and white, red and white or black and white colour schemes could be selected, arranged as five alternate bands with the first and last band being the darker colour (see photo below for a typical example).

- 4.6 If the heliport is intended to be operated at night, the windsock(s) will need to be illuminated. This can be achieved by internal illumination using a floodlight pointing through the wind cone, for example. Alternatively, the windsock can be externally lit using a floodlight. Care should be taken to ensure that any system used to illuminate the windsock highlights the entire cone section while not presenting a source of glare to a pilot operating to the heliport at night.

Figure 4-6: Photograph of windsock - source: Swansea Morrision Hospital



Helicopter landing area markings

Note 1: Aluminium constructions are widely used in the provision of elevated heliports. These tend to be a natural light grey colour and may present painting difficulties. The natural light grey colour of aluminium may be acceptable provided it can be demonstrated that the surface achieves the minimum friction properties specified in Chapter 3, Section 3.39. Where a surface is left unpainted it will normally be necessary to enhance the conspicuity of essential heliport markings by, for example, overlaying markings on a black background or by enhancing the conspicuity of the yellow TD/PM circle, the white cross and the red “H” by outlining them with a thin black line (typically 5-10 cm wide).

Note 2: Guidance on font type, spacing between letters or numerals and between words is given in Annex 14 Volume II, Chapter 5.

- 4.7 Except in the case of note 1 above, the background colour of the heliport should be dark green. The perimeter of the landing area should be clearly marked with a white painted line at least 30 cm wide. Non slip finishes should be used throughout (see Chapter 3).

Figure 4-7: Markings for single main rotor helicopters (hospital)

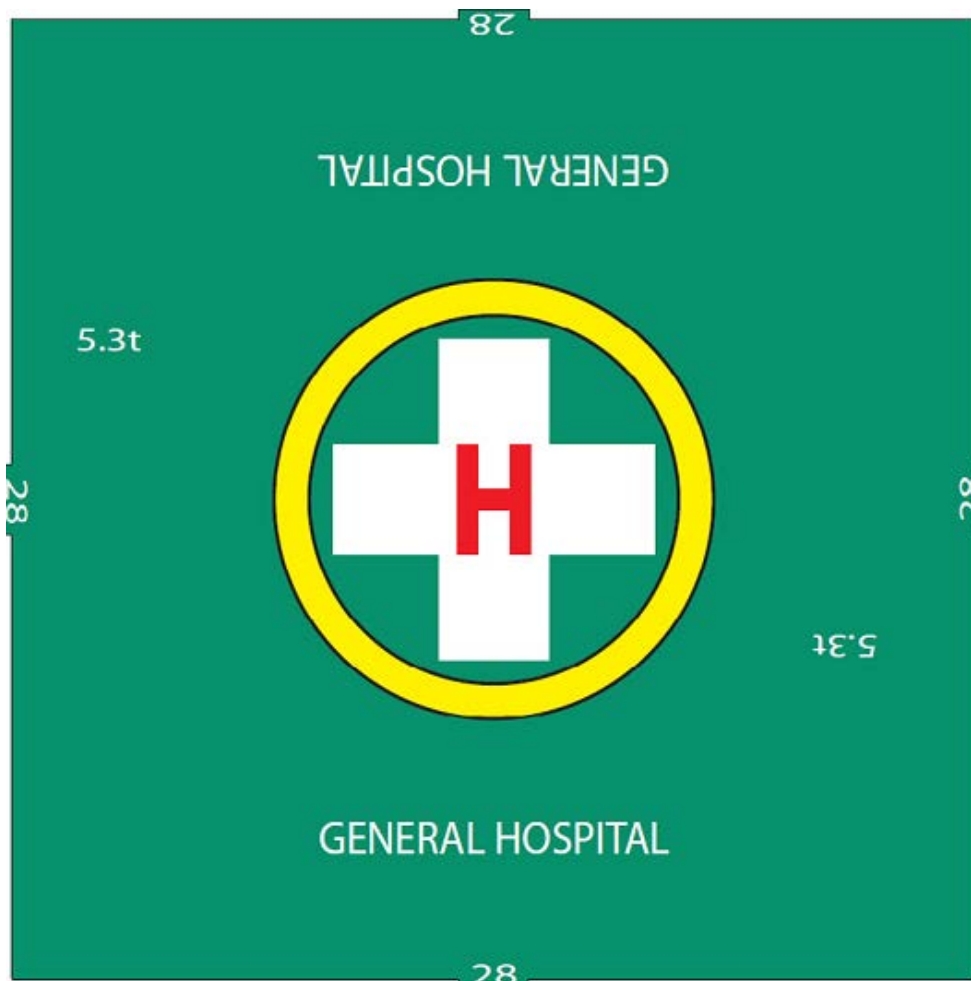

- 4.8 The actual dimensions of the heliport should be marked as a two-digit number within the broken perimeter marking so as to be readable from the preferred final

approach direction(s) in the manner shown in Figure 1 in a contrasting colour (preferably white). The dimensions should be expressed to the nearest whole number with 0.5 rounded down e.g. a square heliport 25.5m x 25.5m should be marked "25m". The characters, to be displayed in two or more locations, should be a minimum height of 90 cm with a line width of approximately 12 cm. However, for large heliports over 30 m, the characters may be increased to a height of not more than 1.5 m with a line width of approximately 20 cm. Where possible the heliport dimension markings should be well separated from other markings such as the heliport identification "H" marking and the maximum allowable mass (t) marking, in order to avoid any confusion with recognition.

- 4.9 A maximum allowable mass marking should be marked on the heliport in two positions readable from the preferred final approach direction(s) adjacent to the perimeter of the landing area in the manner shown in Figure 2. The marking should consist of a two or three-digit number expressed to one decimal place rounded to the nearest 100 kg and suffixed by the letter "t" to indicate the allowable helicopter mass in tonnes (1000 kg) e.g. 5307 kg is expressed "5.3t". The height of the figures should be at least 90 cm, and ideally 1.2m, with a line width of 12-15 cm and be in a colour which contrasts with the heliport surface (preferably white). However, for large heliports over 30 m diameter, characters may be increased to a height of not more than 1.5 m with a line width of approximately 20 cm. Where possible the mass markings should be well separated from other markings such as the heliport name marking, the edge of the TD/PM circle and the heliport dimension markings, in order to avoid confusion with recognition.
- 4.10 A touchdown / positioning marking (TD/PM) circle should be provided and painted in the manner shown in figure 7. The marking, having a width (thickness) of at least 1.0 m (but not greater than 1.1 m), should be a yellow circle with an inner diameter of 10.5m. This is to ensure that the inner edge of the yellow circle surrounds, but does not overlap, the unique hospital heliport white cross marking. The centre of the marking should be located at the centre of the landing area. The location and dimensional characteristics of the TD/PM circle are illustrated in figure 7.
- 4.11 A heliport identification "H" marking should be provided located at the centre of the white cross with the cross bar of the "H" lying perpendicular to the preferred direction of approach (normally based on the prevailing wind direction). For a heliport at a hospital the "H", having dimensions of 3.0m x 2.0m x 0.5m, should be painted in red and superimposed on the white cross, as illustrated in figure 7.
- 4.12 A simple and unique heliport name marking, to facilitate unambiguous communication via an aeronautical radio, should be painted in two locations aligned with the preferred final approach directions in symbols not less than 1.5 m high with a line width of approximately 20 cm and in a colour (normally white)

which contrasts with the heliport surface. Care should be taken to ensure the heliport name markings are distinct and separate from other markings such as the heliport dimension markings and the maximum allowable mass markings; in order to avoid any confusion with recognition. See figure 8.

Figure 4-8: Heliport 'H', white cross and touchdown / positioning marking dimensions

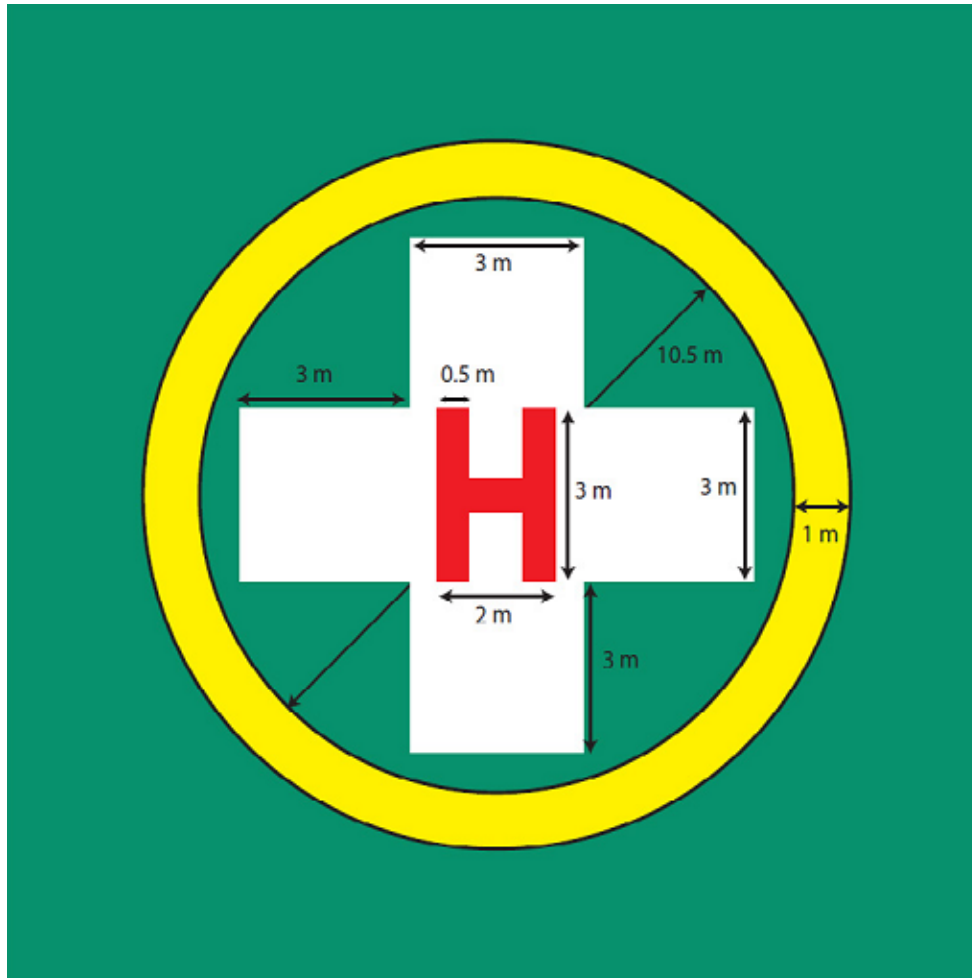

- 4.13 In certain circumstances it may be necessary to protect a helicopter from landing or manoeuvring in close proximity to limiting obstructions, e.g. a marking is applied on the surface to prohibit an otherwise approved back-up procedure in a certain sector, due to obstacles infringing the back-up portion. Where required a prohibited sector is indicated by applying red hatching to the TD/PM, with white and red hatching out to the edge of the landing area. The characteristics for the marking are described fully in [CAP 437: Standards for Offshore Helicopter Landing Areas](#), Chapter 4, section 4.16 and figures 5 and 6.
- 4.14 For certain operational or technical reasons a heliport may have to prohibit helicopter operations. In such circumstances, the 'closed' state of the heliport should be indicated by use of the signal shown in figure 9. This signal is the standard 'landing prohibited' signal given in the Rules of the Air and Air Traffic Control Regulations.

Figure 4-9: Landing prohibited signal for a hospital heliport

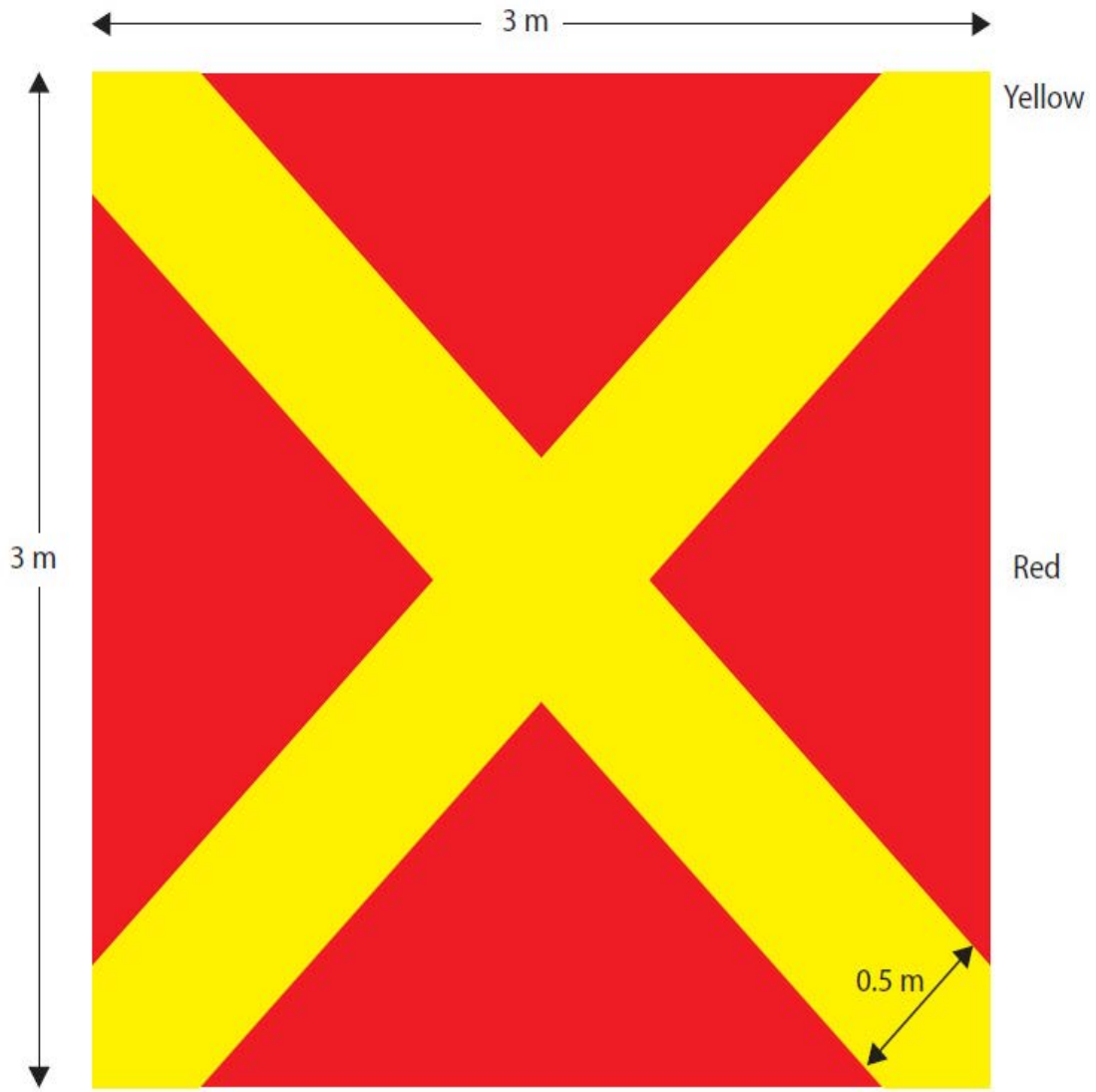

- 4.15 Paint colours should conform to the following BS 381C (1996) standard or equivalent BS 4800 colour. White should conform to RAL charts.

| Colour | Standard |
|------------|---|
| Red | BS 381C:537/ RAL 3001 (Signal Red) BS 4800: 04.E.53/ RAL 2002 (Poppy Red) |
| Yellow | BS 381C:309/ RAL 1018 (Canary Yellow) BS 4800:10.E.53/ RAL 1023 (Sunflower Yellow) |
| Dark Green | BS 381C:267/ RAL 6020 (Deep Chrome Green) BS 4800: 14.C.39 (Holly Green) |
| White | RAL 9010 (Pure White) RAL 9003 (Signal White) |

Helicopter landing area lighting

Note 1: The paragraphs below should be read in conjunction with Appendix D which contains the specification for the full heliport lighting scheme comprising: heliport perimeter lights, lit touchdown / positioning marking and lit green cross (chevron) markings. The specification for each element is fully described in the Appendix with the overall operational requirement detailed in Section 1. The heliport lighting scheme is intended to provide effective visual cues for a pilot throughout the approach and landing manoeuvre at night. No provision is made in the specification for compatibility with night vision enhancing systems e.g. NVIS goggles. Starting with the initial acquisition of the heliport, the lighting should enable a pilot to easily locate the position of the heliport, in an often well-lit congested area of a city or town, at the required range. The lighting should then guide the helicopter to a point above the landing area and provide visual cues to assist with the touchdown.

Note 2: The specification has an in-built assumption that the performance of the lighting system will not be diminished by the presence of any other lighting due to the relative intensity, configuration or colour of other lighting sources on or adjacent to the heliport. Where other non-aeronautical ground lighting under the control of the facility has the

potential to cause confusion or to diminish or prevent the clear interpretation of heliport lighting systems, it will be necessary for the heliport operator to extinguish, screen or otherwise modify these lights to ensure that the effectiveness of the heliport lighting system is not compromised. The CAA recommends that heliport operators give serious consideration to shielding high intensity light sources (e.g. by fitting screens or louvers) from helicopters approaching and landing and maintaining a good colour contrast between the heliport lighting and any surrounding lighting sources. Particular attention should be paid to the areas adjacent to the heliport.

Note 3: All lighting should be fed from a UPS system.

- 4.16 The periphery of the landing area should be delineated by Omni-directional green perimeter lights visible from on and above the landing area. The pattern formed by the lights should not be visible to the pilot from below the elevation of the landing area. Perimeter lights should be mounted above the level of the heliport but should not exceed the height limitations specified in Appendix D, paragraph D14. The lights should be equally spaced at intervals of not more than three metres around the perimeter of the landing area, coincident with the white perimeter marking (see Chapter 4, paragraph 4.7). In the case of square or rectangular decks there should be a minimum of four lights along each side including a light at each corner of the landing area. Flush fitting lights may exceptionally be used at locations along the edge of the landing area where an operational need exists to move items of equipment to and from the landing area, e.g. at the location on the periphery where it is necessary for a stretcher trolley to exit the landing area onto a ramp. Care should be taken to select flush fitting lights that will meet the minimum intensity requirements stated in Appendix D, Table 2.
- 4.17 In order to aid the visual task of final approach and hover and landing it is important that the heliport is adequately illuminated for use at night. In the past this has typically been achieved by providing a system of 8 deck level floodlights mounted around the perimeter of the landing area. Experience has shown, however, that deck level floodlighting systems can adversely affect the visual cueing environment by reducing the conspicuity of green heliport perimeter lights during the approach, and by causing glare and loss of pilots' night vision during the hover and landing. Furthermore, floodlighting systems fail to provide adequate illumination of the centre of the landing area leading to the so called 'black-hole effect'. Even well designed and maintained floodlighting systems do not provide effective visual cueing until within relatively close range of the heliport due to the scale of the visual cues involved.
- 4.18 In view of the well documented weaknesses of heliport floodlighting, the CAA has been seeking to identify better methods for meeting the top-level requirement to provide effective visual cues for night operations, with a particular focus on finding technologies to more adequately highlight the touchdown

markings. Through research programmes initiated in the offshore environment during the 1990's it was demonstrated by a series of dedicated and in-service trials that effective visual cues could be provided by means of a lit touchdown / positioning marking circle and a lit heliport identification "H" marking. This scheme, described in detail in Appendix D, is demonstrated to provide equivalency in the onshore operating environment, usually in a congested area, and has been shown to provide the visual cues required by the pilot earlier on in the approach, and much more effectively than floodlighting and without the disadvantages associated with floodlights such as glare. The CAA believes that the new lighting scheme, first introduced as the offshore variant in [CAP 437](#) Standards for Offshore Helicopter Landing Areas, represents a significant safety enhancement over traditional floodlighting and is seeking every opportunity to actively encourage the onshore industry, to deploy the new lighting scheme in preference to floodlighting. All operators of existing onshore elevated heliports should consider the safety benefits of upgrading their facilities to meet the final specification for a Heliport Lighting System described in Appendix D.

Note: The offshore lighting scheme was developed to be compatible with helicopters having wheeled undercarriages, this being the prevailing configuration on the (offshore) United Kingdom Continental Shelf during the development of the specification. Although compliant with the ICAO maximum obstacle height of 2.5cm and likely to be able to withstand the point loading presented by (typically) lighter skidded aircraft, compatibility when operating skidded helicopters to elevated and raised heliports fitted with the offshore configuration of the lighting cannot be assured. Due to the potential for raised fittings to induce dynamic rollover and/or ground resonance with helicopters equipped with skids, it has been determined that the onshore version of the scheme, often being installed at heliports used by skid-fitted helicopters, should avoid a lit "H" altogether and instead should present green cross markers, which are sufficiently spaced to mitigate any incidence of interaction with skid fitted helicopters. The detail is described in Appendix D, where the height of the system, including any mounting arrangements, should not exceed 2.5 cm above surface level.

- 4.19 The new system described in paragraph 4.18 above, assures that effective visual cueing is provided for the acquisition, approach, hover and landing tasks. In view of the weaknesses described in paragraph 4.17, it is considered that floodlighting systems have proven to be relatively ineffective for these tasks. Their continued use for the provision of primary visual cueing on new build elevated heliports is therefore not supported. However, CAA recognises that in the past, in the absence of any viable alternative, the industry has invested, in good faith, in deck-mounted heliport floodlighting systems. CAA has no objection to these systems conforming to the guidance contained in Appendix H being retained for the purpose of providing a source of illumination for on-deck

operations, such as passenger handling and, where required, for lighting the heliport name marking on the surface or as a back-up to the new lighting. Where the improved lighting system described in Appendix D is retro-fitted at an existing heliport, unless otherwise instructed by aircrew, any floodlights present should be switched off for the entire approach, landing and take-off phases. In addition, particular care should be taken to maintain correct alignment to ensure that floodlights do not cause dazzle or glare to pilots seated in helicopters landed on the heliport. All floodlights should be capable of being switched on and off at the pilot's request.

Obstacles – marking and lighting

- 4.20 Fixed obstacles which present a hazard to helicopters should be readily visible from the air. If a paint scheme is necessary to enhance identification by day, alternate black and white, black and yellow, or red and white bands are recommended, not less than 0.5 metres, or more than six metres wide. The colour scheme should be chosen to contrast with the background to the maximum extent. Paint colours should conform to the references at paragraph 4.15 above.
- 4.21 Omni-directional low intensity steady red obstruction lights conforming to the specifications for low intensity obstacle (Group A) lights described in [CAP 168](#) Licensing of Aerodromes, Chapter 6, Appendix 6D and Table 6A.1, having a minimum intensity of 10 candelas for angles of elevation between 0 degrees and 30 degrees should be fitted at suitable locations to provide the helicopter pilot with visual information on the proximity and height of objects which are higher than the landing area and which are close to it. Objects which are more than 15 metres higher than the landing area should be fitted with intermediate low intensity steady red obstruction lights of the same intensity spaced at 10 metre intervals down to the level of the landing area (except where such lights would be obscured by other objects).
- 4.22 Omni-directional low intensity steady red obstruction lights should be fitted to the highest point of dominant obstacles that are above the landing area. The light should conform to the specifications for a low intensity obstacle (Group B) light described in [CAP 168](#) Licensing of Aerodromes, Chapter 6, Appendix 6D and Table 6A.1, having a minimum intensity of 50 candelas for angles of elevation between 0 and 15 degrees, and a minimum intensity of 200 candelas between 5 and 8 degrees. Where it is not practicable to fit a light to the highest point of a dominant obstacle the light should be fitted as near to the extremity as possible.
- 4.23 Red lights should be arranged so that the locations of the objects which they delineate are visible from all directions of approach above the landing area. Any failures or outages should be reported immediately to the helicopter operator.

- 4.24 For certain obstacles it may be more effective to use floodlighting to illuminate the obstruction rather than fixed red lights. One example could be where it is necessary to highlight trees. The use of floodlighting is permitted provided care is exercised to ensure that lighting used does not present a source of glare to pilots operating to the heliport.
- 4.25 A number of supplementary heliport visual aids are specified by Annex 14 volume II and are commercially available to assist helicopters operating to a heliport located in a congested area by day and/or by night. Additional aids may be provided including a heliport beacon, a visual alignment guidance system and visual approach slope indicator, a lit helicopter aiming point marker, a flight path alignment guidance marking / lighting system and an approach lighting system. These systems are summarised in the table below. Full system specifications are presented in Annex 14 Volume II. See also [CAP 637](#), Visual Aids handbook which provides examples of visual aids peculiar to helicopter operations.

| System name and function | Rationale for recommendation | System description |
|---|---|---|
| Heliport beacon (for heliport acquisition) | Where long range visual guidance is considered necessary and is not provided by other visual means or where identification of the heliport is difficult due to surrounding lights. | A beacon is located on, or adjacent to the heliport preferably at an elevated position. ICAO Annex 14 Volume II reference: Section 5.3.2. |
| Visual alignment guidance system (to assist a helicopter to maintain an 'on track' approach based on the centreline of the FATO) | <p>Provided to serve an approach to a heliport where one or more of the following conditions exist especially at night:</p> <ul style="list-style-type: none"> a) obstacle clearance, noise abatement or ATC procedures require a particular track to be flown; b) the environment of the heliport provides few visual surface cues and; c) it is physically impractical to install an approach lighting system. | Two units located equidistant on either side of the centreline of the FATO at the downwind edge of the FATO, in the safety area and aligned along the preferred approach direction. ICAO Annex 14 Volume II reference: Section 5.3.5. |

| System name and function | Rationale for recommendation | System description |
|--|--|--|
| <p>Visual approach slope indicator</p> <p>(to assist a helicopter to maintain an approach slope which will guide it down to a desired position in the FATO)</p> | <p>Provided to serve an approach to a heliport where one or more of the following conditions exist especially at night:</p> <ul style="list-style-type: none"> a) obstacle clearance, noise abatement or ATC procedures require a particular slope to be flown; b) the environment of the heliport provides few visual surface cues and; c) the characteristics of the helicopter required a stabilised approach. | <p>A unit should be located in the safety area adjacent to the nominal aiming point and aligned in azimuth with the preferred approach direction. ICAO Annex 14 Volume II reference: Section 5.3.6.</p> |
| <p>Approach lighting system</p> <p>(to provide enhanced visual guidance for a straight-in approach in the preferred direction of approach)</p> | <p>An approach lighting system should be provided at a heliport where it is desirable and practicable to indicate a preferred approach direction.</p> | <p>A row of three lights spaced uniformly at 30m intervals in a straight line with a cross bar of 5 lights (18m width) located 90m from the end of the FATO. ICAO Annex 14 Volume II reference: Section 5.3.3.</p> |
| <p>Flight path alignment guidance marking and lighting system</p> <p>(to provide flight path alignment guidance in the direction of approach and/or departure)</p> | <p>Where it is desirable and practicable to indicate available approach and/or departure path directions, but where there is insufficient area to provide a full approach lighting system (see above).</p> | <p>Marking and lighting may be located in the TLOF, FATO or safety area or on any suitable surface in the vicinity.</p> <p>Markings consist of one or more arrows containing three or more lights with 1.5m to 3.0m spacing. ICAO Annex 14 Volume II references: Section 5.2.18 and 5.3.4.</p> |

| System name and function | Rationale for recommendation | System description |
|--|--|--|
| Helicopter aiming point marker lighting (to assist a pilot at night to approach to a hover over a desired position within the FATO) | Applies to a surface level heliport where it is necessary for a pilot to make an approach to a particular point within the FATO before proceeding to a remote TLOF to touchdown. | A 9m x 9m triangle with six lights placed equidistantly within the triangle. ICAO Annex 14 Volume II reference: Section 5.3.8. |

Chapter 5

Helicopter fire-fighting services

Introduction

- 5.1 This chapter presents standards for the appropriate level of fire protection for elevated heliports located within the UK at or above 3m above the surface of the surrounding terrain.
- 5.2 The consequences resulting from post-crash fire following an accident or serious incident on an elevated heliport has been assessed to be potentially catastrophic, while the likelihood of post-crash fire based on an analysis of accidents and incidents for operations to elevated heliports in the UK, has been assessed as improbable. All flights for which Rules of the Air Rule 5 Permissions are necessary will attract a condition that recommended levels of fire fighting protection and response for operations to elevated heliports are in accordance with this chapter (or that an acceptable alternative means of compliance has been applied instead). This condition will be applied to all Rule 5 Permissions whether issued for public transport operations by FOI (H) or for private operations by FOI (GA). The minimum levels of extinguishing agents are listed below in Sections 5.6 to 5.28.
- 5.3 It is foreseeable that an accident could result in a fuel spill with a fire situation which could quickly cut off or reduce the already limited routes of escape to a place of safety for the helicopter occupants. The purpose for providing integrated fire fighting services (FFS) at an elevated heliport is to rapidly suppress any fire that occurs within the confines of the heliport response area (see note 1 in Appendix F) to allow occupants of a helicopter, with assistance, to evacuate to safety and, when appropriate, to protect personnel in the building beneath the heliport from the effects of a helicopter fire situation.
- 5.4 Local fire and rescue authorities should be consulted at the earliest stages of the planning and provision of an elevated heliport to ensure that proper consideration is given to the effect that an accident could have on the structure below, above which the heliport is located. An aviation-related fire and/or fuel spillage poses a risk to the structure below the heliport, which if a building, may have consequences for fire and for the means of escape both from the heliport and from within the building. To protect the occupants of the building, the fire and rescue authorities may require provisions in addition to those requirements set out in this chapter, provided for the initial suppression and control of a fire arising anywhere on the heliport response area.

- 5.5 Furthermore the local fire and rescue authority has to consider its response to the heliport and its tactics. The local fire and rescue authority should be informed immediately of any incident or accident on the heliport to allow post-initial fire and specialist rescue assistance to be provided by them (see section Emergency Response Arrangements). To this end the local fire and rescue authorities should be familiarised with access routes to the heliport and the capabilities of integral on-site FFS. Consequently, taking account the access arrangements to an elevated (rooftop) heliport, the requirement for the amount of extinguishing agent at elevated heliports is based on a fire fighting action which, depending on the design of the surface, may be required to last longer than at a surface level heliport (see Chapter 8). In addition, to achieve a rapid 'knock-down' response the system employed should be capable of providing immediate intervention on the heliport response area while helicopter operations are taking place.

Key design characteristics for the effective application of the principal agent

- 5.6 A key aspect in the successful design for providing an efficient, integrated heliport fire fighting facility is a complete understanding of the circumstances in which it may be expected to operate. A helicopter accident, which results in a fuel spillage with wreckage and/or fire and smoke, has the capability to render some of the equipment unusable or preclude the use of some escape routes.
- 5.7 Delivery of the principal agent to the whole of the landing area at the appropriate application rate should be achieved in the quickest possible time. The CAA recommends that a delay of not more than 15 seconds, measured from the time the system is activated to actual delivery of fire extinguishing media at the required application rate, should be the objective. This objective can be achieved by use of an automatic detection system but, preferably by a single action undertaken by a Responsible Person (RP) trained for the task. The operational objective then is to sufficiently suppress, so as to bring under control the fire, ideally within 30 seconds of initial application.
- 5.8 FFS provision at elevated heliports should take into consideration the particular difficulties that may be encountered should an incident or accident occur during operations. One such difficulty may be the confined and restricted space available on an elevated heliport. Foam-making equipment and the capability of the fire pump(s) should be of adequate performance in terms of application rate, and discharge area and duration, and be suitably located to ensure an effective application of foam to any part of the landing area, irrespective of the wind strength / direction or accident / incident location. All equipment should be

regularly inspected and tested to ensure it operates in accordance with its design specifications

- 5.9 To achieve the objectives of 5.7 and 5.8 in an efficient and effective manner, heliport operators are strongly encouraged to consider the provision of a deck integrated fire-fighting system (DIFFS), whether capable of foam discharge on a standard solid plate deck, or providing a water-only DIFFS capability when used in tandem with a passive fire-retarding surface (see paragraph 5.12). These systems typically consist of a series of 'pop-up' nozzles, with both a horizontal and vertical component, designed to provide an effective dispersed pattern spray distribution of foam or water to the whole of the landing area and therefore provide protection for the helicopter for the range of weather conditions prevalent at the heliport. A DIFFS provision on a standard purpose-built (solid plate) heliport should be capable of supplying ICAO Performance Level B or Level C foam solution, to bring under control a fire associated with a crashed helicopter to achieve the operational objective described in paragraph 5.7. In order to meet the operational objective in all weather conditions, consideration should be given to achieving an average (theoretical) application rate over the entire landing area of 5.5 litres per square metre per minute for Level B foams (or, when applicable, water – see paragraph 5.12) and 3.75 litres per square metre per minute for Level C foams, for a duration, which at least meets the minimum requirements stated in paragraph 5.17 below.

Note: For some systems fixed nozzles (typically referred to as 'non-pop up') may sit very slightly proud of the surrounding deck surface prior to activation, making it unnecessary for them to physically 'pop-up' on activation of the system.

- 5.10 The precise number and lay out of pop-up nozzles will be dependent on the specific heliport design, particularly the shape and overall dimensions of the landing area – the objective is to ensure that the pattern of pop-up nozzles will allow foam (or water) to be distributed to all parts of the response area as defined in Appendix F note 1. However, pop-up nozzles should not be located in close proximity of heliport access / egress points as this may hamper quick access to the heliport by trained local authority rescue crews and responsible person(s) and/or impede occupants of the helicopter escaping to a safe place beyond the heliport response area - by presenting a potential obstacle near to an access location. Notwithstanding this, the number and lay out of nozzles should be sufficient to provide an effective spray distribution of firefighting media over the entire FATO with a suitable overlap of the horizontal spray component from each nozzle assuming calm wind conditions. It is recognised, in seeking to meet the objective for an average (theoretical) application rate specified for Performance Level B or C foams (or water) to all parts of a potentially large heliport, there will be areas of the FATO where the application rate in practice may fall below the average (theoretical) application rate specified in 5.9. This is acceptable provided that the actual application rate achieved for any portion of

the FATO does not fall below two-thirds of the rate specified for the critical area calculation.

- 5.11 To provide responding local authority fire fighters with a fire fighting capability at heliport level, it is recommended to supply a hand controlled branch pipe(s) with a minimum discharge rate of 225 L/min. Where provided a hand controlled branch pipe(s) should be sited in an easily accessible upwind location close to primary and secondary access points and, for standard solid plate heliports, branch pipes should have the capability of delivering aspirated foam. When used in tandem with a passive fire-retarding surface the delivery of water-only is permitted.
- 5.12 Where a DIFFS is used in tandem with a passive fire-retarding system, consisting in a perforated / grated surface, which, in the event of a fuel spill from a ruptured aircraft tank, has been demonstrated to be capable of removing significant quantities of unburned fuel from the surface of the heliport, a water-only DIFFS to deal with any residual fuel burn may be considered in lieu of a foam system. A water-only DIFFS, removing the need for periodic foam quality testing, should meet the same average (theoretical) application rate and duration as specified in paragraph 5.9 and 5.15 for a performance Level B foam DIFFS.
- Note:** When considering the option for a passive fire retarding system typically constructed in the form of a perforated surface or grating, it is important to fully evaluate the surface design (i.e. the size and shape of the holes) to ensure it does not promote a reduction in beneficial ground 'cushion' effect, and so adversely affect the performance of any helicopter types that are likely to use the heliport.
- 5.13 The required minimum capacity of the foam production (or water-only) system will therefore be predicated on the overall area of the heliport, the required foam application rate, discharge rates of installed equipment and the expected duration of application. It is important that the capacity of the main heliport fire pump is sufficient to ensure that foam solution, can be applied at the appropriate induction ratio and application rate, for the minimum duration, to the whole of the FATO, when all components of the DIFFS are operating in accordance with the manufacturer's technical specifications for the equipment. Formulae for the calculation of application rate, discharge duration and minimum operational stocks, based on the assumption that Performance Level C foam is used, are presented in the following paragraphs using a worked example which assumes the application of a Level C foam applied to a typical 25 m x 25 m elevated heliport laid out as a square.
- 5.14 Level C foams should be applied at a minimum application rate of 3.75 litres per square metre per minute based on the overall area of the FATO, which for the purposes of the following illustration, is assumed to be a 25 m x 25 m FATO, suitable for operation of the AW 189.

- 5.15 A 25 m x 25 m FATO assumes a total area of required coverage of 625 m². Based on an application rate of 3.75 litres per square metre per minute the application rate per minute is $625 \times 3.75 = 2344$ litres.
- 5.16 Given the difficulties in quickly accessing an elevated heliport from ground level it is necessary to assume that no assistance will be available from external trained sources during the initial suppression, control and evacuation phases. Therefore the overall capacity of the foam system should comfortably exceed that necessary for initial control and suppression of a fire plus a quantity available, held-back for a second 'attack' should the original foam blanket, when applied on a solid plate heliport, subsequently break down, causing a previously suppressed fire to re-ignite. In consideration of this, three minutes' discharge capability is generally seen by the CAA to be reasonable.
- 5.17 Calculation of total foam discharge and minimum operational stocks:
- 5.18 Using the 25 m x 25 m worked example shown in paragraph 5.15 above, the total required discharge for Level C foam, assuming three minutes' discharge duration, is $2344 \times 3 = 7,032$ litres.
- 5.19 A 3% performance Level C foam solution discharged over three minutes at the minimum application rate will require the following stock of foam concentrate (based on a standard 3% solution):
- 5.20 $2,344 \times 3\% \times 3 = 211$ litres of foam concentrate.

Note 1: Sufficient reserve foam stocks to allow for replenishment as a result of operation of the system during an incident or following training or testing, should also be considered.

Note 2: From time-to-time new technologies will come to market which, providing they are demonstrated by rigorous testing to be at least as effective as solutions described elsewhere in this chapter, may be considered as an acceptable alternative means of compliance (AltMoC) for the provision of heliport fire-fighting at new build installations. For example, a further reduction in foam capacity requirements may be considered with the use of compressed air foam systems (CAFS) with foam distributed through a DIFFS. CAFS has the ability to inject compressed air into foam to generate an effective solution to attack and suppress a heliport fire. This type of foam has a tighter, denser bubble structure than standard foams which in theory allows it to penetrate deeper into the fire before the bubbles are broken down. CAFS has added potential to address all sides of the fire triangle by smothering the fire (preventing oxygen from combining with the fuel), diminishing the heat using trapped air within the bubble structure, and disrupting the chemical reaction required for a fire to continue. Hence the provision of a DIFFS using an ICAO performance level B compressed air foam has potential to reduce the application rate still further. Consistent with

Chapter 5 of CAP 437, the application rate for an ICAO Performance Level B compressed air foam is three litres per square metre per minute.

Any CAFS solution considered will need to take full account of the (windy) weather conditions usually prevalent on rooftop elevated heliports.

- 5.21 For a solid plate heliport, a three minute foam discharge capability is generally considered to be reasonable. In the case of a passive fire-retarding surface with a water-only DIFFS, the discharge duration may be reduced to no less than two (2) minutes, with the calculations above in paragraphs 5.18 to 5.20, adjusted accordingly.

Complementary media

- 5.22 While foam is considered the principal medium for dealing with fires involving fuel spillages, other fire incidents that may be encountered during helicopter operations – e.g. engine, avionic bays, transmission areas, hydraulics – may require the provision of complementary agent. Dry powder and gaseous agents are generally considered acceptable for this task. The complementary agents selected should comply with the appropriate specifications of the International Organisation for Standardisation (ISO). Extinguishers should be capable of delivering the agents through equipment which will ensure its effective application.
- 5.23 The minimum total capacity of Dry Powder should be 45 kg of dry chemical powder, delivered from one, or preferably two, extinguishers. The dry powder system should have the capability to deliver the agent anywhere on the landing area and the discharge rate of the agent used should be selected for optimum effectiveness.
- 5.24 The CAA recommends that the heliport operator considers the use of a gaseous agent, in addition to the use of dry powder, as a secondary complementary agent. Therefore, in addition to dry powder specified at paragraph 5.23 operators should consider a quantity of gaseous agent provided with a suitable applicator for use on engine fires. The appropriate minimum quantity delivered from one, or preferably two, extinguishers is 18 kg. The discharge rate of the agent should be selected for optimum effectiveness of the agent. Due regard should be paid to the requirement to deliver gaseous agent to the seat of the fire at the recommended discharge rate. Because of the weather conditions prevalent on rooftop elevated heliports, complementary agents can be adversely affected during application and training evolutions, and this should be taken into account.
- 5.25 All helicopters have integral engine fire protection systems (predominantly Halon) and it is therefore considered, for a solid plate heliport, that provision of

foam as the principal agent plus sufficient levels of dry powder will form the core of the fire extinguishing system.

- 5.26 Dry powder should be of the 'foam compatible' type (but not essential where a water-only DIFFS is used).
- 5.27 The dry powder and gaseous agents should be sited so that they are readily available at all times and capable of being transported by one or two responsible persons.
- 5.28 Reserve stocks of complementary agents to allow for replenishment as a result of activation during an incident, or following training or testing, should be considered .
- 5.29 Complementary agents should be subject to annual visual inspection by a competent person and pressure testing in accordance with manufacturers' recommendations.

Note: Halon extinguishing agents are no longer specified for new installations. Gaseous agents, including CO₂, have replaced them. The effectiveness of CO₂ is accepted as being half that of Halon.

The management and maintenance of media stocks

- 5.30 Consignments of extinguishing media should be used in delivery order to prevent deterioration in quality by prolonged storage.
- 5.31 The mixing of different types of foam concentrate may cause serious sludging and possible malfunctioning of foam production systems. Unless evidence to the contrary is available, it should be assumed that different types are incompatible. In these circumstances it is essential that the tank(s), pipe work and pump (if fitted) are thoroughly cleaned and flushed prior to the new concentrate being introduced.
- 5.32 It is important to ensure that foam containers and tanks are correctly labelled.
- 5.33 Induction equipment ensures that water and foam concentrate are mixed in the correct proportions. Settings of adjustable inductors, if installed, should correspond with the strength of concentrate in use.
- 5.34 All parts of the foam production system, including the finished foam, where applicable, should be tested by a competent person on commissioning and periodically thereafter. The duration of tests should be long enough to assess the performance of the system against original design expectations while ensuring compliance with any relevant pollution regulations.

Equipment

- 5.35 Consideration should be given to the effects of the weather on static equipment. All equipment forming part of the facility should be designed to withstand protracted exposure to the elements or be protected from them. Where protection is the chosen option, it should be securely fitted but not prevent the equipment being brought into use quickly and effectively. The effects of condensation on stored equipment should be considered.
- 5.36 For night operations sufficient illumination of an incident should be provided.

Life-saving equipment

- 5.37 A first aid kit together with a seat belt cutter should be available in the vicinity of the landing area and signposted if necessary.

Emergency planning arrangements

- 5.38 The objective of the emergency plan is to anticipate the affects that a helicopter emergency might have on life, property, and operations, and to prepare a course, or courses, of action to minimise those effects, particularly in respect of preserving lives.
- 5.39 The emergency plan should provide for the co-ordination of the actions to be taken in an emergency occurring at the heliport or in its vicinity.
- 5.40 Emergency instructions should provide details to individuals, or to departments, of the actions required to initiate the emergency plan.
- 5.41 The plan should co-ordinate the response or participation of all existing agencies, which, in the opinion of the Trust / Board and the appropriate local fire authority, could be of assistance in responding to an emergency.
- 5.42 The plan should consider the likely delay of responding emergency services arriving at the heliport response area, and the arrangements to ensure fire suppression, the resources needed for casualty extraction and the administering of first aid to casualties.
- 5.43 The emergency plan should include procedures for assisting passengers escaping the helicopter, leading them to secure areas away from the scene of an incident.
- 5.44 Equipment should be available to ensure that all agencies can effectively communicate with each other during an emergency, the provision of a control centre within the building should be considered to coordinate the plan.

- 5.45 The emergency plan should be tested prior to the initial operation of the heliport and biennially thereafter.

Further advice

- 5.46 Advice is available from the CAA's Aerodrome Standards Department regarding the choice and specification of fire extinguishing agents and the development of an emergency plan.
- 5.47 In certain circumstances (see also Appendix F) alternative firefighting equipment, such as fixed monitors, may be appropriate however this will involve the provision of trained staff to operate the equipment. A ring-main system (RMS) may be considered for a heliport with a diameter of less than 20.00 m.
- 5.48 As fixed monitor systems deliver primary media in a solid stream, rather than a dispersed pattern as for DIFFS, the calculation for the amount of primary media (i.e. level B or C foam) for a solid plate surface is predicated on a critical area which considers the fuselage dimensions for a range of helicopters, categorised between H0 and H3, and assumes a discharge duration, in all cases, of 5 minutes. These assumptions, and the resultant usable amounts of extinguishing agents, are summarised in the following tables:

Note: A given helicopter has to be within the limits for both parameters, fuselage length and fuselage width, to take advantage of a particular FFS category. If either dimension is exceeded, that type should apply assumptions for the higher FFS category.

Table 5-1: Heliport firefighting category

| Heliport firefighting category | Maximum fuselage length | Maximum fuselage width |
|--------------------------------|--|------------------------|
| H0 | up to but not including 8 m | 1.5 m |
| H1 | from 8 m up to but not including 12 m | 2 m |
| H2 | from 12 m up to but not including 16 m | 2.5 m |
| H3 | from 16 m up to 20 m | 3 m |

Table 5-2: Minimum usable amounts of extinguishing agents for elevated heliports

| Category | Foam meeting performance level B | | Foam meeting performance level C | | Complementary agents | |
|----------|----------------------------------|---|----------------------------------|---|--------------------------|--------------------|
| | Water (L) | Discharge rate foam solution/minute (L) | Water (L) | Discharge rate foam solution/minute (L) | Dry chemical powder (kg) | Gaseous media (kg) |
| (1) | (2) | (3) | (4) | (5) | (6) | (7) |
| H 0 | 1 250 | 250 | 825 | 165 | 23 | 9 |
| H 1 | 2 000 | 400 | 1 350 | 270 | 45 | 18 |
| H 2 | 3 000 | 600 | 2 000 | 400 | 45 | 18 |
| H 3 | 4 000 | 800 | 2 750 | 550 | 90 | 36 |

5.49 For further guidance on Initial emergency response requirements for elevated heliports, refer to Appendix F.

Chapter 6

Miscellaneous operational standards

General precautions

- 6.1 Whenever a helicopter is stationary on board an elevated heliport with its rotors turning, except in cases of emergency, no person should enter upon or move about the helicopter landing area otherwise than within the view of a helicopter flight crew member, and at a safe distance from the engine exhausts and tail rotor of the helicopter. It may also be dangerous to pass under the main rotor disc in front of a helicopter which has a low main rotor profile.
- 6.2 The practical implementation of paragraph 6.1 is best served through consultation with the helicopter operator for a clear understanding of the approach paths approved for personnel and danger areas associated with a rotors-running helicopter. These areas are type specific, but in general, the approved routes to and from the helicopter are at the 2-4 o'clock and 8-10 o'clock positions. Avoidance of the 12 o'clock (low main rotor profile helicopters) and the 6 o'clock (tail rotor) danger area positions should be maintained at all times.
- 6.3 Personnel should not approach the helicopter while the helicopter anti-collision (rotating / flashing) beacons are operating.

Helicopter operations support equipment

- 6.4 Provision should be made for equipment needed for use in connection with helicopter operations including:
- a) Chocks and tie-down strops and;
 - b) Equipment for clearing the helicopter landing area of snow and ice and of other contaminants

Note: Anti-icing and de-icing agents for heliports may be sourced from products that are commercially available for use at aerodromes. Typically, these products are based on Urea, Glycol or Potassium, and the criteria for the selection of the most appropriate liquid-form agent, will depend on surface type, intended use, effectiveness and environmental impact. The requirement for clearance of snow or ice may be minimised by equipping a purpose-built heliport with a heat tracing system - see Chapter 1, Section 1.32.

- 6.5 Provision of a suitable power source for starting helicopters should be considered if helicopter shut-down is seen to be an operational requirement
- 6.6 Chocks should be compatible with helicopter undercarriage / wheel configurations. Several types are commonly available: the 'NATO sandbag' type, a 'rubber triangular' or 'single piece fore and aft' type chock may be used as long as they are suited to all helicopters likely to operate to the heliport.
- 6.7 For securing helicopters to tie-down points on the heliport surface it is recommended that adjustable tie-down strops are used in preference to ropes. Specifications for tie-downs should be agreed with helicopter operator(s).

Chapter 7

Heliports located on raised structures

Concept and definition

- 7.1 For new build installations at UK hospitals there is an increasing demand to specify heliports located on raised structures which due of their elevation above surface (ground) level (by definition less than 3m above the surrounding terrain on at least two sides) are categorised neither as elevated heliports nor as heliports at surface (ground) level. It becomes necessary therefore to provide both a stand-alone definition and additional good practice guidance for heliports located on low level raised structures. The guidance set out in the following chapter should be read, as appropriate, in conjunction with chapters 1 through to 6.
- 7.2 In the glossary of terms and abbreviations a Heliport on a raised structure is defined as a heliport located on a raised structure which is less than 3m above the surrounding terrain. Typically such arrangements consist in a purpose built helicopter landing area located on top of a single storey building or structure, which invariably will make use of the area beneath the heliport for non-aviation purposes such as for hospital car parking. See Figure 1 below.

Figure 1: A heliport on a raised structure over a car park



Introduction

- 7.3 According to Table 1 in Chapter 1 which provides a subjective comparison of heliport facilities based at ground level, mounded, raised structure and elevated (rooftop) sites, for most aspects of the design and operation of a heliport located on a raised structure the ease or difficulty of meeting each of the listed criterion is comparatively determined as “amber” i.e. moderate. However, when it comes to building costs, especially if addressing a case for a deck integrated fire fighting service (DIFFS) the colour coded ‘rating’ would advance to “red”. In practice the case for an integrated FFS will be dependent on the outcome of a risk assessment conducted by the heliport operator – see Appendix I for guidance. Where the outcome of the risk assessment determines that an integrated FFS is deemed necessary, it is expected the assumptions used to determine the key design characteristics / performance of the DIFFS will be the same as for an elevated heliport. For a heliport on a raised structure, the FFS provision is further discussed in Section 6 of this chapter (and in Chapter 5 for elevated heliports).
- 7.4 Although the building costs are likely to be in a similar ballpark to those where the specification is for a rooftop structure, depending on the fire fighting strategy / philosophy, the overall costs of a raised heliport may be lower than for a rooftop facility. However, when it comes to the preservation of unobstructed flight paths to and from the heliport, and the mitigation of rotor downwash effects, a raised heliport has more in common with a surface (ground) level heliport than with a rooftop heliport, particularly if the latter is located multiple storeys above the level of the surrounding surface. Therefore, for a raised heliport care needs to be exercised to ensure unobstructed flight paths are not encroached upon / compromised by other developments, which may grow up in the vicinity of the heliport, especially if siting a new structure more than a single storey above the surface. Unless future developments at the hospital is strictly controlled and limited, with the growth of obstacles it is possible in time that an operation to a raised heliport will be compromised and become restricted, or in the worst case, the heliport may become unusable due to obstructions around the heliport. Further guidance on safeguarding an HLS is provided in CAP 738.
- 7.5 In addition to the impact of obstacles, designers need to be aware of the effects caused by helicopter rotor downwash and blade tip vortices on persons and property (particularly loose objects) that may be present in the vicinity of, and below, the heliport. As with a surface level heliport, it is strongly recommended to establish a downwash zone around the touchdown and lift-off area which during helicopter operations is kept clear of people and loose articles (e.g. light and insecure objects) to avoid injuries and damage from any debris that might be disturbed as a result of downwash or blade tip vortices. For small to medium air ambulance helicopters a 30m downwash zone is recommended. For large

helicopters such as are operated in the SAR role, and for military helicopters, an extended downwash zone should be provided which is typically 50m – 65m beyond the centre of the touchdown and lift-off area.

Helicopter performance considerations

- 7.6 Consistent with the concept and definition for a raised heliport (see Section 1) unless specifically stated otherwise by the Rotorcraft Flight Manual (RFM), the dimensional requirements published in the RFM applicable for the ground level (PC1) helipad procedure should be assumed for operations to a raised heliport.
- 7.7 An approved 'helipad' take-off profile for a surface level heliport often entails an upwards and rearwards (or sideways) manoeuvre or a vertical lift, all to a pre-determined point called the take-off decision point (TDP), whereupon if all is well, the helicopter will transition into forward flight. Should the engine fail while the helicopter is climbing initially to TDP, using the available visual references provided at the heliport, a pilot is able to land safely back on the surface (hence a need for dimensions that incorporate a rejected take-off area and for load bearing capabilities of the surface that will accommodate a 'one-engine-inoperative' emergency landing). For the take-off manoeuvre, if an engine should fail after the initiation of transition into forward flight, at or beyond TDP, the pilot is able to swap height for speed and continue his departure manoeuvre from the heliport avoiding all obstacles on the surface by a vertical margin of not less than 35'. For the landing manoeuvre, if an engine should fail at any point at, or before, the landing decision point (LDP), it is possible either to land and stop within the available landing area or to perform a baulked landing and clear all obstacles in the flight path by a vertical margin of 35'.
- 7.8 Where an upwards and rearwards profile is flown according to approved techniques in the RFM, it will be necessary to consider and account for obstacles that may be present underneath the flight path during a helicopter's back-up manoeuvre to take-off decision point. An illustration of this concept is shown in Appendix C for a helicopter that utilises an upwards and backwards manoeuvre (e.g. EC 135); and illustrates the prescribed limitation surfaces imposed for the restriction of obstacles permitted to be present on the surface beneath the back-up portion of the profile flown. This basic generic illustration is extracted from EASA Acceptable Means of Compliance and Guidance Material to Part-CAT (AMC1 CAT.POL.H.205 (e)). CAT.POL.H.205 (e) requires that for a take-off using a backup or lateral transition procedure, with the critical engine failure recognition at or before the TDP, all obstacles in the back-up or lateral transition area should be cleared by an adequate margin.

Note: Where large or very large helicopters are required to operate to a heliport it is important to consider the third-party risk posed to persons and property on

the ground, in particular as a result of the downwash effect generated. Where effects are pronounced the provision of a raised heliport, being only within 3m of the surrounding surface, may not be the appropriate option; in this case a better option could be to provide an elevated heliport located above the tallest building within the hospital complex, or, to cater for large or very large helicopters, a surface level HLS located well away from the environment of the congested hospital (e.g. in a near-by playing field).

Physical characteristics

- 7.9 Designers of heliports on raised structures when considering the physical characteristics of the facility should pay careful attention to Chapter 3 of this CAP. In particular, wherever practical, the heliport design considerations in relation to environmental effects including mitigation of turbulence and thermal effects should make use of the same good design practices applied for purpose-built elevated (roof top) heliports; and the environmental criteria within Section 2 of Chapter 3 should be adopted. The heliport structural design requirements of Section 3 are also pertinent to a purpose-built raised structure. The basic size and obstacle requirements for the heliport, the characteristics of the surface, the tie-down arrangement, the safety netting and access / egress arrangements will be very similar, if not identical, to best practice applied for a rooftop elevated heliport. Even the provision of a lift or a dedicated ramp may be an important design feature for a raised heliport.

Visual aids

- 7.10 The marking and lighting requirements for a raised heliport are considered identical to those specified in Chapter 4 and Appendix D for a rooftop (elevated) heliport. The process for assessment of obstacle markings and, in particular, for obstacle lighting may be more demanding for a raised heliport due to the relatively lower elevation of the landing area in relation to dominant obstructions; generally much lower in elevation than for a rooftop heliport. Consequently there could be more dominant obstacles (buildings etc) in the vicinity of a raised heliport for which full consideration of obstacle lighting and marking needs to be given.
- 7.11 In respect to wind direction indicator(s), it is recommended that at least one wind sock be located in clean air at heliport level. Consideration should be given to increasing the dimensions of the windsock to be compatible with the 'sock specified for a surface level heliport i.e. 2.4m in length with a 0.6m diameter cone at the larger end and a 0.3m diameter cone at the smaller end. For other marking requirements follow Chapter 4, Section 1.

- 7.12 For advice and guidance on the specifications for helicopter ground and air taxiways and helicopter stands in support of a raised heliport refer to Appendix E.

Heliport Rescue and Fire Fighting Services (RFFS)

- 7.13 For heliports located less than 3m above the surrounding terrain that are not arranged over an occupied building, the provision of integral on-site Fire Fighting Services (FFS) is not considered mandatory provided it can be demonstrated through a risk analysis that any additional risks that arise due to the location and/or elevation of the heliport are fully mitigated (see Appendix I). However, if the opportunities for saving lives is to be maximised an essential element of a risk analysis is the requirement to ensure an effective fire-fighting intervention (e.g. by Local Authority Fire and Rescue Appliances) that guarantees rapid, unimpeded access to any location on the landing area to address all reasonably foreseeable helicopter fire scenarios that may occur on the heliport. Where the level of risk is deemed to support an immediate dedicated response capability, guidance to select an appropriate standard is provided in Chapter 5 of CAP 1264. For the design and provision of a deck integrated fire fighting system, to provide a rapid knock down and suppression of a heliport fire (e.g. worse case helicopter crash and burn), Chapter 5 of this CAP may be similarly applied to a raised heliport.

Miscellaneous operational standards

- 7.14 Operators of heliports on raised structures should follow the best practice in Chapter 6, General Precautions (Sections 6.1 to 6.3) and Helicopter Operations Support Equipment (Sections 6.4 to 6.6).

Chapter 8

Surface level and mounded heliports

Concept and definition

- 8.1 For new build installations at UK hospitals, often the most cost efficient and simplest solution for the siting of a heliport is to provide a dedicated facility at surface (ground) level. On occasions, to achieve adequate clearance from obstacles that may be situated on the ground around a heliport, but protrude above protected surfaces, it may be possible to improve the obstacle environment by providing a mounded heliport suitably landscaped to rise above obstacles on the adjacent surrounding surface. Philosophically this is still regarded as a surface level heliport but is somewhat different from a heliport that is provided on flat ground at surface level. The two arrangements are illustrated at Figure 1 (surface level heliport) and Figure 2 (mounded heliport) below. Since each variation is distinct from a heliport on a raised structure (see Chapter 7) or an elevated heliport on a rooftop (see Chapter 1-6), it is necessary to provide both a definition and some additional good practice guidance for heliports designed at surface level; whether or not forming a mounded arrangement. Supplementary guidance is set out in the following chapter which should be read, as appropriate, in conjunction with chapters 1 through to 6.
- 8.2 According to the glossary of terms and abbreviations a Surface Level heliport includes a heliport located on the ground which when specifically prepared and landscaped, may exist as a mounded heliport. See Figures 1 and 2 below.

Figure 1: A heliport at surface (ground) level (Romford Hospital helipad)



Figure 2: A mounded heliport at surface level (Ospedale Negrar)

Introduction

- 8.3 According to Table 1 in Chapter 1 comparing the design and construction of heliport facilities at ground level, mounded, raised and elevated (rooftop) sites, for the cost element of the design and for the operation of a ground level heliport, the ease or difficulty of meeting each criterion is comparatively gauged as “green” i.e. easiest. However, while a facility located at ground level is likely to be least expensive to construct and to operate, it is also the most difficult to provide (and to maintain) clear and unobstructed flight paths to and from the heliport and is also much more prone to the adverse effects of rotor downwash in the vicinity of the heliport. Given also the general scarcity of available real estate at hospitals, it is likely to be a significant challenge to locate a surface level heliport that is both within easy access of ED but sufficiently remote to ensure rotor downwash effects do not have a detrimental impact on persons and property around the heliport. To mitigate the potential adverse effects of rotor downwash, for small-medium air ambulance helicopters, it is recommended that

a 30m downwash zone be established all around the touchdown and lift-off area which, during helicopter operations, is kept clear of people and loose articles or light or insecure objects, to avoid injuries and damage from debris that might be disturbed by the mass downwash effect and/or by vortices generated at the blade tips. For large and very large helicopters, where the effects of rotor downwash are likely to be even more pronounced, an appreciably larger downwash zone should be considered; typically a 50m – 65m zone should be provided and measured from the centre of the touchdown and lift-off area.

- 8.4 Also unless future development at the hospital is strictly controlled and limited, it is possible, in time, that the operation of a ground level site will become restricted or even unusable where the environment around the heliport is compromised due to other developments (this has been the experience at several surface level heliports in the UK where uncontrolled development around the heliport has forced helicopter operations to cease). Further guidance on safeguarding an HLS is provided in [CAP 738](#).
- 8.5 The overall cost of providing a surface level heliport, whether or not on a mound, will be significantly impacted by the decision whether or not to provide an integral Fire Fighting Service (FFS) at the heliport (effectively mandated for an elevated heliport – see Chapter 5). For heliports at surface level this is further discussed in section 8.19 of this chapter.

Helicopter performance considerations

- 8.6 For heliports that are specifically located on the surface (i.e. at ground level) according to the Rotorcraft Flight Manual (RFM), the performance requirements and handling techniques may involve either a 'clear area' procedure, a 'short-field' procedure or similar 'helipad' profiles and techniques as are utilised for an elevated or raised heliport (see Chapters 3 and 7 and Appendix C).
- 8.7 A helicopter performing a clear area procedure at a surface level site such as in a large field is optimised for take-off by accelerating from a low hover, and remaining close to the surface until the helicopter achieves a safe single engine climb-out speed; typically about 30 to 40 kts. If an engine fails during the acceleration phase the take-off can be aborted and a safe forced landing performed in an obstacle free area having a surface capable of accommodating loads generated by a rejected take-off. The amount of clear area required for a typical air ambulance helicopter is in the order of 250 to 300 metres. A clear area procedure will generate the best pay-load but requires the most ground space to complete the manoeuvre safely.
- 8.8 A compromise between a clear area procedure and a vertical take-off and landing profile is a short field procedure. This profile applies some characteristics

from both the clear area and the vertical procedure, generating reasonable pay loads by utilising a technique that requires less ground space than for a clear area procedure.

- 8.9 Another approved take-off profile for a surface heliport entails an upwards and rearwards manoeuvre or a vertical lift, to a pre-determined point called the take-off decision point (TDP), whereupon if all is well the helicopter will transition into forward flight. Should the engine fail while the helicopter is climbing initially to TDP, the pilot is able to land safely back on the heliport (hence the need for added dimensions which incorporate a rejected take-off area and for load bearing characteristics on the surface which accommodate a 'one-engine-inoperative' emergency landing). If an engine should fail after initiating the transition into forward flight, at or beyond TDP, the pilot is able to swap height for speed and, in accordance with performance class one procedures, continue his take-off and departure manoeuvre from the heliport avoiding all obstacles on the ground by a vertical margin of not less than 35 feet. (The surfaces prescribed for heliports designed for helicopters operated in performance class one are addressed in Chapter 3, Table 4-1).
- 8.10 Where an upwards and rearwards profile is flown according to approved techniques in the RFM, it will be necessary to consider, and account for, obstacles that may be present underneath the flight path during a helicopter's rearward manoeuvre up to take-off decision point. An illustration of concept is shown in Appendix C which illustrates typical prescribed limitation surfaces imposed for the restriction of obstacles permitted to be on the surface beneath the back-up portion of the profile flown. Designers of heliports should be aware that Appendix C is for illustration of concept purposes only and where profiles are to be operated using these techniques, reference to up-to-date type-specific RFM data will need to be applied. The illustration in Appendix C is extracted from EASA Acceptable Means of Compliance and Guidance Material to Part-CAT (AMC1 CAT.POL.H.205 (e)).

Note: Where large or very large helicopters are required to operate to a hospital it is important to consider the third-party risk posed to persons and property on the ground, in particular as a result of the significant downwash generated by large and very large helicopters (see section 8.3 above regarding the provision of a minimum 50m – 65m downwash zone). In this case the provision of a dedicated surface level or mounded heliport within the hospital complex may not be an appropriate option; a better option could be to identify an additional HLS well away from the congested hospital environment which may be operated by large or very large helicopters (e.g. in near-by playing fields).

Physical characteristics

- 8.11 Designers of heliports at surface level, when considering the physical characteristics of the FATO, should pay careful attention to Chapter 3 of this CAP. In particular, wherever practical, the heliport design considerations in relation to environmental effects including mitigation of turbulence and temperature effects should make use of the good design practices applied to purpose-built structures and the relevant 'environmental' criteria within section 2 of Chapter 3. The heliport structural design requirements of the ICAO Heliport Manual are applied for a surface level heliport noting that as designs have to accommodate helicopters operating in performance class 1, the surface should be capable of withstanding a rejected take-off, which may well equate to an emergency landing. Therefore, in accordance with the ICAO Heliport Manual, the bearing strength of the FATO, incorporating the rejected take-off area, should cover an emergency landing with a rate of descent of 3.6 m/s. The design load in this case should be taken as 1.66 times the maximum take-off mass of the heaviest helicopter for which the FATO is intended.
- 8.12 In accordance with Annex 14 Volume II (section 3.1), the FATO should provide rapid drainage with a mean slope in any direction not exceeding 3%. No portion of the FATO should have a local slope exceeding 5%. In addition the surface of the FATO should be resistant to the effects of rotor downwash and be free of irregularities that would adversely affect the take-off or landing of helicopters operated in performance class 1.
- 8.13 The touchdown and lift-off area (the TLOF) will normally be located within the FATO. The TLOF should be a minimum of 1D, and be dynamic load bearing, with a mean slope not exceeding 2%; but sufficient slope to prevent the accumulation of water.
- 8.14 Surrounding the FATO will be a safety area out to an overall dimension of at least 2D. (See Figure 3 below) The surface of the safety area abutting the FATO should be continuous with the FATO, and when solid should not exceed an upward slope of 4% outwards from the edge of the FATO. Objects located around the edge of the FATO, such as perimeter lighting, should be located in the safety area and should not penetrate a plane originating at a height of 25 cm above the plane of the FATO (minimum distance of essential objects from the centre of the FATO should be 0.75D). The surface of the safety area should be treated to prevent flying debris caused by rotor downwash.

Note: There should be a protected side slope rising at 45 degrees from the edge of the safety area to a distance of 10m whose surface should not be penetrated by obstacles, except that when obstacles are located to one side of the FATO only, they may be permitted to penetrate the side slope surface.

Figure 3 FATO and associated safety area

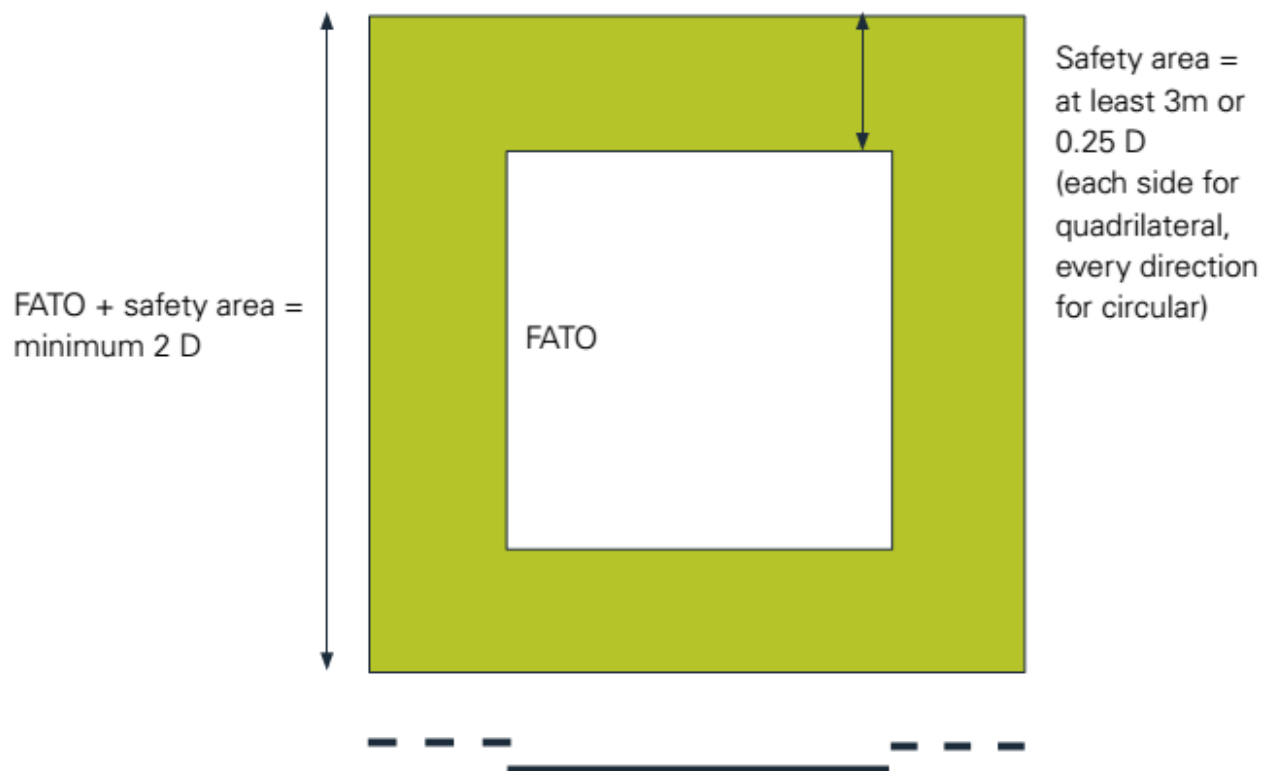

- 8.15 For helicopter operations in PC1 a helicopter clearway would need to be considered and, where provided, located beyond the end of the FATO. The width of the clearway should not be less than that of the associated FATO plus safety area and the ground should not project above a plane having an upward slope of 3% (the lower limit of this plane is located on the periphery of the FATO). Any objects situated within the helicopter clearway, which may endanger helicopters in the air, should be regarded as obstacles and therefore removed. The definition for a helicopter clearway is provided in the glossary of terms and abbreviations.
- 8.16 The design requirements for helicopter ground and air taxiways and helicopter stands provided in support of surface level heliports are addressed in detail in Appendix E.

Visual aids

- 8.17 In respect to wind direction indicator(s), it is recommended that at least one windsock is located in clean air above surface level. The dimensions of the 'sock should be compatible with that provided in Annex 14 Volume II for surface level heliports i.e. 2.4m in length with a 0.6m diameter cone at the larger end and a

0.3m diameter cone at the smaller end. For heliport marking requirements surface level heliports should follow Chapter 4 except that the background colour of the heliport may be left unpainted, provided that good conspicuity with the immediate surrounding terrain is maintained (note: it would be unhelpful to paint the background dark green if the adjacent area is grass – See Figure 1. For heliport lighting arrangements, where these are required to be displayed for operations at night, surface level heliports may continue to follow the good practice disseminated in CAA's letter to industry dated 16 February 2007 reference: 10A/254/24. This letter is available on request from CAA, Future Safety's Policy section. Alternatively, heliport lighting systems incorporating a lit green "cross" and yellow touchdown / positioning marking circle may be provided as described in detail in Appendix D.

- 8.18 The marking and lighting requirements for helicopter ground and air taxiways and helicopter stands provided in support of surface level heliports are addressed in detail in Appendix E.

Heliport Rescue and Fire Fighting Services (RFFS)

- 8.19 For heliports located at surface level or mounded heliport sites that are assumed to have access to Local Authority Fire and Rescue Appliances, the provision of on-site Fire Fighting Services (FFS) is not considered mandatory provided it can be demonstrated through a risk analysis that any additional risks that arise due to the location and/or elevation of the heliport are fully mitigated (see sample Risk Assessment in Appendix I). However, if the opportunities for saving lives are to be maximised an essential component of any risk analysis is a requirement to ensure an effective fire-fighting intervention (e.g. by Local Authority Fire and Rescue Appliances) that guarantees rapid, unimpeded access to any location on the heliport to address all reasonably foreseeable helicopter fire scenarios that may occur on the heliport. Where the level of risk is deemed to support an immediate dedicated response capability (see Appendix I), guidance on the selection of an appropriate standard is provided in CAP 789, Annex 3 to Chapter 21.

Miscellaneous operational standards

- 8.20 Operators of surface level heliports should follow the best practice in Chapter 6, section 1 'General Precautions' and section 2 'Helicopter Operations Support Equipment'.

Appendix A

Heliport checklist

Example of core items checklist

AERODROME: <Insert Name> Hospital Helicopter Landing Site

| Core items | |
|------------|---|
| 1 | Helideck dimensions |
| 2 | Surface landing area (elevated helipad) |
| 3 | Helideck lighting |
| 4 | Helideck environment |
| 5 | Visual aids |
| 6 | Obstacle protected surfaces |
| 7 | Rescue and fire service provisions |
| 8 | Extinguishing media |
| 9 | Platform facility |
| 10 | Personal protective equipment |
| 11 | Media discharge test |
| 12 | Fire-fighter accommodation |
| 13 | Personal protective equipment |
| 14 | Fire fighter staffing and competency |

Inspection of <Insert Name> Hospital Helicopter Landing Site

Following satisfactory review of final helipad drawings and feasibility study report by XXXXX and XXXXX, a site visit and inspection was undertaken on <insert date>, in accordance with

International Civil Aviation Organisation International Standards and Recommended Practices (Annex 14

Volume II), HBN 15:03, UK Air Navigation Order and Rules of Air Regulations, European Aviation Safety Agency (Air Operations Regulations), operational, maintenance and training regulations which may affect the future operation of the heliport.

On meeting the relevant criteria, CAAi will issue Certificate of Completion to certify that the helipad is ready for flight operations.

The following persons were present during the site visit and inspection:

<List names and organisations of those present> This document forms the outcome of the site visit and inspection including detail of actions required.

Report produced by: XXXX and XXXX For CAA International Ltd

Date: <insert date>

| 1 | Helideck Dimensions | | Action |
|----------|--|--|---------------|
| 1.1 | Helideck dimensions (length and width, or diameter) in metres | | |
| 1.2 | Deck shape (circular, square, octagonal, other) | | |
| 1.3 | Load bearing category (limit in metric tonnes to 1 decimal place) | | |
| 1.4 | Scale drawings of helipad arrangements including helipad as marked drawing | | |

| 2 | Surface Landing Area Conditions (Elevated Helipad) | | Action |
|----------|--|--|---------------|
| 2.1 | Type of Surface, condition, friction characteristics (aggregate added to paint for markings, friction test to validate), markings contaminant free | | |
| 2.2 | Perimeter safety netting (not less than 1.5m wide and not more than 2.0m wide (drop test certificate by supplier. No hazardous gaps in all round defence). | | |
| 2.3 | Tie-down points (recessed into surface, for pattern see CAP 437, Chapter 3, Figure 3) | | |
| 2.4 | Helideck – Leak test | | |
| 2.5 | Bolting Control Report | | |

| 3 | Helideck Lighting | | Action |
|----------|---|--|---------------|
| 3.1 | Helideck lighting design | | |
| 3.2 | Night Lighting Test | | |
| 3.3 | Conditions and security of ramp, safety netting, handrails, surface and operational and associated domestic lighting (that it does not present a glare issue for the pilot) | | |
| 3.4 | Standby generator | | |

| 4 | Environment | | Action |
|----------|---|--|---------------|
| 4.1 | Has the heliport been subjected to appropriate wind tunnel testing or CFD analysis | | |
| 4.2 | Minimum 3m air-gap beneath the helipad | | |
| 4.3 | Turbulence generators, Flues and other exhausts | | |
| 4.4 | Adjacent fixed, mobile, structures and turbulence generators | | |
| 4.5 | Choice of preferred approach departure flight paths to optimise wind and noise, nuisance considerations (at least two approach and take-off climb surfaces present) | | |

| 5 | Obstacle Protected Surfaces (minima) | | Action |
|-----|--|--|--------|
| 5.1 | Obstacle-free sectors, 2 flight paths ideally separated by 180 degrees | | |
| 5.2 | No obstacles on the operational surface of the helipad (within the perimeter white lines) exceeding 25mm and no essential obstacles around the landing area surface or in the surrounding Safety Area higher than 250mm. (includes helipad lighting, foam monitors, any handrails) | | |

| 6 | Visual Aids | | Action |
|-----|---|--|--------|
| 6.1 | Markings, friction characteristics when dry and wet; (brushed concrete, metal ribbed, sand blasted or epoxy resin painted finish) | | |
| 6.2 | General condition, good contrasting colour and dimensions of painted markings; (non slip paint, not thermoplastic types) | | |

| | | | |
|------|---|--|--|
| 6.3 | Location / colour of H (red, 3m x 1.8m x 0.4m minimum, set over a white cross) | | |
| 6.4 | Touchdown and lift-off circle, width and diameter (surrounding white cross) | | |
| 6.5 | D-value marked in two locations within perimeter line (elevated helipads only) | | |
| 6.6 | Maximum allowable mass marking to one decimal place e.g. 9.3t (elevated helipads only) | | |
| 6.7 | Illuminated wind indicator, size / colour of wind sleeve, location, lighting and access for servicing | | |
| 6.8 | Perimeter lighting (colour- green, condition and operational spaced every 3m) | | |
| 6.9 | Floodlighting (type, numbers, condition, adjustment and operation) | | |
| 6.10 | Obstruction lighting (location, accessibility, condition and operation) | | |

| | | | |
|------|--|--|--|
| 6.11 | Marking of dominant obstacles close to heliport / helipad, prohibited landing approach sectors (as required) | | |
| 6.12 | CCTV | | |
| 6.12 | Anemometer / wind speed | | |
| 6.13 | Helideck de-icing facility | | |
| 6.14 | Shielding of ambient / domestic lighting sources from helipad operations | | |
| 6.15 | Glide slope indicator (HAPI) if provided | | |
| 6.16 | Heliport Beacon, if provided | | |
| 6.17 | Other lighting aids (e.g. flight path alignment guidance lighting) , if provided | | |

| RFFS Provisions | | | |
|------------------------|-------------------------------------|--|---------------|
| 7 | Minimum Scale of Service | | Action |
| 7.1 | RFFS Protection (H1 or H2) Elevated | | |
| 7.2 | Day or Night or both | | |
| 7.3 | Refuelling | | |

| 8 | Extinguishing Equipment & Media | | Action |
|----------|--|--|---------------|
| 8.1 | Fire Protection and Completion Certificate | | |
| 8.2 | Principal Fire fighting agent Type and Certificate of Conformity | | |
| 8.3 | • Location | | |
| 8.4 | • Quantity | | |
| 8.5 | • Shelf life | | |
| 8.6 | Foam Monitor | | |

| 9 | Extinguishing Media (Water) | | Action |
|----------|------------------------------------|--|---------------|
| 9.1 | Water supply (500ltr/1 min) | | |

| 10 | Platform | | Action |
|-----------|---|--|---------------|
| 10.1 | • Access | | |
| 10.2 | • Fire fighting platform | | |
| 10.3 | • Emergency egress | | |
| 10.4 | • Waterproof storage cabinets | | |
| 10.5 | • Rescue equipment as per CAP 437 (branch pipe, hose, rescue equipment) | | |
| 10.6 | Drainage | | |

| 11 | Discharge test | | Action |
|-----------|--|--|---------------|
| 11.1 | Water & foam discharge output test. | | |
| 11.2 | Isolate each monitor | | |
| | <p>Full coverage of the helipad in moderate wind conditions (15knts) should be demonstrated by each monitor or by 1 monitor and hand line prepositioned upwind.</p> <ul style="list-style-type: none"> • Jet range • Spray pattern | | |
| 11.3 | Operate the hose line to reach all parts of the deck | | |
| 11.4 | Refill Test | | |
| 11.5 | Foam Sample Test | | |
| a | • Induction | | |
| b | • Expansion | | |
| c | • Drainage | | |
| 11.6 | Flush system | | |
| 11.7 | Replenish | | |

| 12 | RFFS Domestic Accommodation Facility | | Action |
|-----------|---|--|---------------|
| 12.1 | Accommodation facility | | |

| 13 | Fire-fighters PPE | | Action |
|-----------|---|--|---------------|
| 13.1 | Helmet, flashood, tunic, leggings, boots, gloves, RPE | | |

| 14 | Staffing Levels and Emergency Procedures | | Action |
|-------|---|--|--------|
| 14.1 | Normal and emergency access / egress points to and from helipad and fire fighting platforms | | |
| 14.2 | Building / LFB alert system and access to helipad through building fire core or external RFFS staircase | | |
| 14.3 | Helipad, normal and emergency communication system | | |
| 14.4 | Check warning notice on access approach routes to helipad | | |
| 14.5 | Check availability of helipad operational / no fly flag (yellow cross on red background) | | |
| 14.6 | Provision of a Helipad operating manual | | |
| 14.7 | RFFS crewing level | | |
| 14.8 | RFFS training, competence, qualification | | |
| 14.9 | RFFS Rescue equipment | | |
| 14.10 | Medical equipment | | |
| 14.11 | Emergency planning arrangements | | |
| 14.12 | Arrangements for LAFRS to familiarise with the location and access routes | | |

| | | | |
|-------|--|--|--|
| 14.13 | Off helipad incident response capability | | |
| 14.14 | Bird scaring mechanism | | |

Notes

Issue of Certificate: Yes / No

Items detailed with actions will need to be addressed satisfactorily to meet the relevant criteria.

Appendix B Bibliography

Civil Aviation Authority – CAPs and research papers

| | |
|-----------------------------------|--|
| CAP 168 | Licensing of Aerodromes |
| CAP 437 | Standards for Offshore Helicopter Landing Areas (8th Edition, AL2018-01) |
| CAP 452 | Aeronautical Radio Station Operator's Guide |
| CAP 637 | Visual Aids Handbook |
| CAP 738 | Safeguarding of Aerodromes |
| CAP 748 | Aircraft Fuelling and Fuel Installation Management |
| CAP 789 | Requirements and Guidance Material for Operators |
| CAP 793 | Operating Practices at Unlicensed Aerodromes |
| CAA Paper 98002 | Friction Characteristics of Helidecks on Offshore Fixed-Manned Installations |
| CAA Paper 2007/02 | Visualisation of Offshore Gas Turbine Exhaust Plumes |
| CAA Paper 2008/03 | Helideck Design Considerations: Environmental Effects |

International Civil Aviation Organisation (ICAO) and European Aviation Safety Agency (EASA)

| | |
|--|--|
| ICAO Annex 14 Volume II | Heliports (4th Edition, July 2013) |
| ICAO Doc 9261/AN 903 | Heliport Manual (1995) |
| ICAO Annex 6 Part III | International Operations – Helicopters |
| EASA Requirements for Air Operators, Operational Requirements Part-OPS, Annex IV Part-CAT or Annex VI Part-SPA | |

Other publications

| | |
|--|--|
| BHA Helicopter site keepers guidance... | www.britishhelicopterassociation.org |
| The Health and Safety at Work etc Act 1974 HMSO 1974 | |

Oil and Gas UK Guidelines for the Management of Aviation Operations Issue 6 April 2011

Department of Health, Health Building Note 15:03: Hospital helipads (2008) – now withdrawn

Association of Air Ambulances – Rotor Aircraft Landing Facilities, Light / Medium Aircraft Report December 2014

Appendix C

An illustration of obstacle clearances in the backup area

Obstacle clearances in the backup area

- C1 The requirements in CAT.POL.H.205(e) has been established in order to take into account the following factors:
1. in the backup: the pilot has few visual cues and has only to rely on the altimeter and sight picture through the front window (if flight path guidance is not provided) to achieve an accurate rearward flight path;
 2. in the rejected take-off: the pilot has to be able to manage the descent against a varying forward speed whilst still ensuring an adequate clearance from obstacles until the helicopter gets in close proximity for landing on the FATO; and
 3. in the continued take-off: the pilot has to be able to accelerate to V_{TOSS} (take-off safety speed for Category A helicopters) whilst ensuring an adequate clearance from obstacles
- C2 The requirements of CAT.POL.H.205(e) may be achieved by establishing that:
1. in the backup area no obstacles are located within the safety zone below the rearward flight path when described in the AFM (see Figure 1, in the absence of such data in the AFM, the operator should contact the manufacturer in order to define a safety zone); or
 2. during the backup, the rejected take-off and the continued take-off manoeuvres, obstacles clearance is demonstrated to the competent authority.

Figure C-1: Rearward flight path

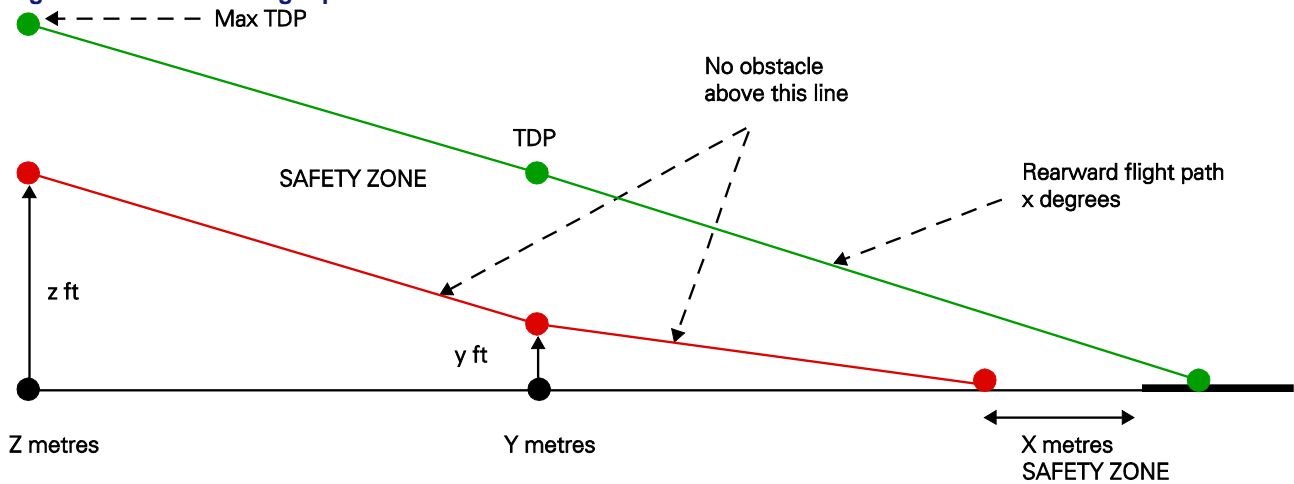

- C3 An obstacle, in the backup area, is considered if its lateral distance from the nearest point on the surface below the intended flight path is not further than:
1. half of the minimum FATO (or the equivalent term used in the AFM) width defined in the AFM (or, when no width is defined 0.75 D, where D is the largest dimension of the helicopter when the rotors are turning); plus
 2. 0.25 times D (or 3m, whichever is greater); plus
 3. 0.10 for VFR day, or 0.15 for VFR night, of the distance travelled from the back of the FATO (see Figure C-2).

Figure C-2: Obstacle accountability

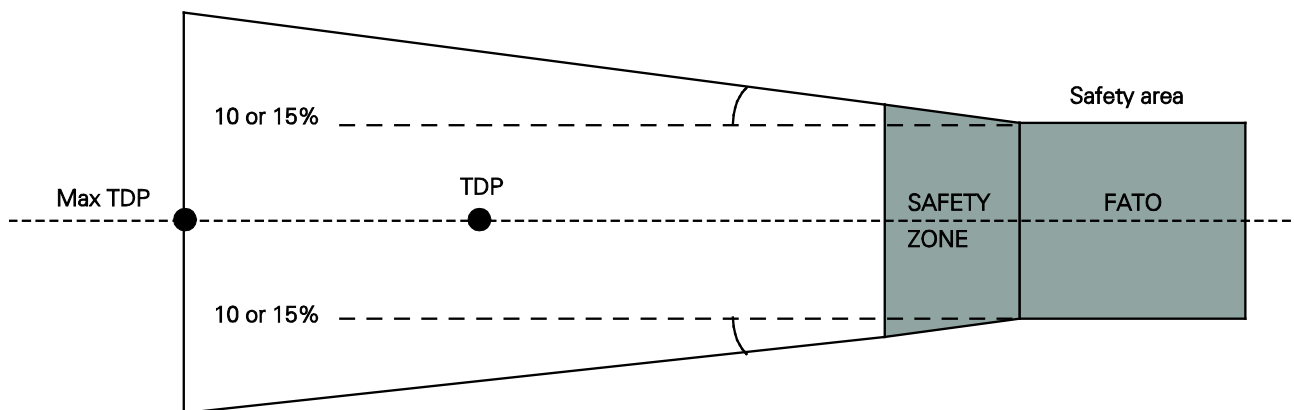

Appendix D

Specification for Heliport Lighting Scheme: Comprising Perimeter Lights, Lit Touchdown/Positioning Marking and Lit Cross Marking

Overall Operational Requirement

- D1 The whole lighting configuration should be visible over a range of 360° in azimuth.
- D2 The visibility of the lighting configuration should be compatible with operations in a meteorological visibility of 3000 m.
- D3 The purpose of the lighting configuration is to aid the helicopter pilot perform the necessary visual tasks during approach and landing as detailed in Table D-1.

Table D-1: Visual Tasks During Approach and Landing

| Phase of Approach | Visual Task | Visual Cues/ Aids | Desired Range (NM) |
|--------------------------------------|---|---|--------------------|
| | | | 3000m met. vis. |
| Heliport Location and Identification | Search for heliport within the hospital complex. | Shape of heliport, colour of heliport, luminance of heliport, perimeter lighting. | 1.1 (2km) |
| Final Approach | Detect helicopter position in three axes. Detect rate of change of position. | Apparent size / shape and change of size / shape of heliport. Orientation and change of orientation of known features/ markings/ lights. | 0.75 (1.4 km) |

| | | | |
|-------------------|--|---|--------------------|
| Hover and Landing | Detect helicopter attitude position and rate of change of position in three axes (six degrees of freedom). | Known features/ markings/ lights. Heliport texture. | 0.03 (50 m) |
|-------------------|--|---|--------------------|

- D4 The minimum intensities of the lighting configuration should be adequate to ensure that, for a minimum Meteorological Visibility (Met. Vis.) of 3000 m and an illuminance threshold of $10^{-6.1}$ lux, each feature of the system is visible and useable at night from ranges in accordance with D5, D6 and D7 (below).
- D5 The Perimeter Lights are to be visible and usable at night from a minimum range of 1.1 NM.
- D6 The Touchdown/Positioning Marking (TD/PM) circle on the heliport is to be visible and usable at night from a range of 0.75 NM.
- D7 The cross marking is to be visible and usable at night from a range of 0.375 NM.
- D8 The design of the Perimeter Lights, TD/PM circle and cross marking should be such that the luminance of the Perimeter Lights is equal to or greater than that of the TD/PM circle segments, and the luminance of the TD/PM circle segments equal to or greater than that of the cross marking.

Definitions

The following definitions should apply.

Lighting element

- D9 A lighting element is a light source within a segment or sub-section and may be discrete (e.g. a Light Emitting Diode (LED)) or continuous (e.g. fibre optic cable, electro luminescent panel). An individual lighting element may consist of a single light source or multiple light sources arranged in a group or cluster and may include a lens/diffuser.

Segment

- D10 A segment is a section of the TD/PM circle lighting. For the purposes of this specification, the dimensions of a segment are the length and width of the smallest possible rectangular area that is defined by the outer edges of the lighting elements, including any lenses/diffusers.

Sub-section

D11 A sub-section is an individual section of the cross marking lighting. For the purposes of this specification, the dimensions of a sub-section are the length and width of the smallest possible rectangular area that is defined by the outer edges of the lighting elements, including any lenses/diffusers.

The perimeter light requirement

Configuration

D12 Perimeter lights, spaced at intervals of not more than 3 m, should be fitted around the perimeter of the landing area of the heliport as described in Section 3 of Chapter 4.

Mechanical constraints

D13 The perimeter lights should not exceed a height of 25 cm above the surface of the heliport.

Light intensity

D14 The minimum light intensity profile is given in Table D-2 below:

Table D-2: Minimum Light Intensity Profile for Perimeter Lights

| Elevation | Azimuth | Intensity (min) |
|--------------|----------------|-----------------|
| 0° to 10° | -180° to +180° | 30 cd |
| >10° to 20° | -180° to +180° | 15 cd |
| > 20° to 90° | -180° to +180° | 3 cd |

D15 No perimeter light should have an intensity of greater than 60 cd at any angle of elevation. Note that the design of the perimeter lights should be such that the luminance of the perimeter lights is equal to or greater than that of the TD/PM circle segments.

Colour

D16 The colour of the light emitted by the perimeter lights should be green, as defined in ICAO Annex 14 Volume 1 Appendix 1, paragraph 2.3.1(c), whose chromaticity lies within the following boundaries:

Yellow boundary $x = 0.310$

White boundary $x = 0.625y - 0.041$

Blue boundary $y = 0.400$

Note: The above assumes that solid state light sources are used. ICAO Annex 14 Volume 1 Appendix 1, paragraph 2.1.1(c) should be applied if filament light sources are used.

Serviceability

D17 The perimeter lighting is considered serviceable provided that at least 90% of the lights are serviceable, and providing that no two adjacent lights are unserviceable.

The touchdown / positioning marking circle requirement

Configuration

D18 The lit TD/PM circle should be superimposed on the yellow painted marking such that it is concentric with the painted circle and contained within it. It should comprise one or more concentric circles of at least 16 discrete lighting segments, of at least 40 mm minimum width. A single circle should be positioned such that the radius of the circle formed by the centreline of the lighting segments is within 10 cm of the mean radius of the painted circle. For an onshore hospital which has to display a 9 m x 9 m white cross, the inner diameter of the TD/PM circle is fixed at 10.5 m. Therefore, the centreline of the circle should always be at a radius of 5.75 m. Four gaps of between 1.5 m and 2.0 m, aligned with the 'arms' of the white cross should be provided to permit stretcher trolley access. The lighting segments should be of such a length as to provide coverage of between 50% and 75% of the circumference populated by lighting segments (i.e. the four 1.5 to 2 m access gaps are to be excluded from this calculation), and be equidistantly placed with the gaps between them not less than 0.5 m. The mechanical housing should be coloured yellow - see Chapter 4 paragraph 4.15.

Mechanical constraints

D19 The height of the lit TD/PM circle fixtures (e.g. segments) and any associated cabling should be as low as possible and should not exceed 25 mm above the surface of the heliport when fitted. So as not to present a trip hazard, the segments should not present any vertical outside edge greater than 6 mm without chamfering at an angle not exceeding 30° from the horizontal.

The overall effect of the lighting segments and cabling on deck friction should be minimised. Wherever practical, the surfaces of the lighting segments should meet the minimum deck friction limit coefficient (μ) of 0.6, e.g. on non-illuminated surfaces.

The TD/PM circle lighting components, fitments and cabling should be able to withstand a pressure of at least 2,280 kPa (331 lbs/in²), without damage.

Intensity

D20 The light intensity for each of the lighting segments, when viewed at angles of azimuth over the range + 80° to -80° from the normal to the longitudinal axis of the strip (see Figure D-1), should be as defined in Table D-3.

For the remaining angles of azimuth on either side of the longitudinal axis of the segment, the maximum intensity should be as defined in Table D-3; the minimum intensity values are not applicable.

Note that the intensity of each lighting segment should be nominally symmetrical about its longitudinal axis.

Note also that the design of the TD/PM circle should be such that the luminance of the TD/PM circle segments is equal to or greater than those of the cross chevrons.

Table D-3: Light Intensity for TD/PM Circle Lighting Segments

| Elevation | Intensity | |
|-------------|--|-------|
| | Min | Max |
| 0° to 10° | As a function of segment length as defined in Figure 2 | 60 cd |
| >10° to 20° | 25% of min intensity >0° to 10° | 45 cd |
| >20° to 90° | 5% of min intensity >0° to 10° | 15 cd |

Figure D-1: TD/PM Segment Measurement Axis System

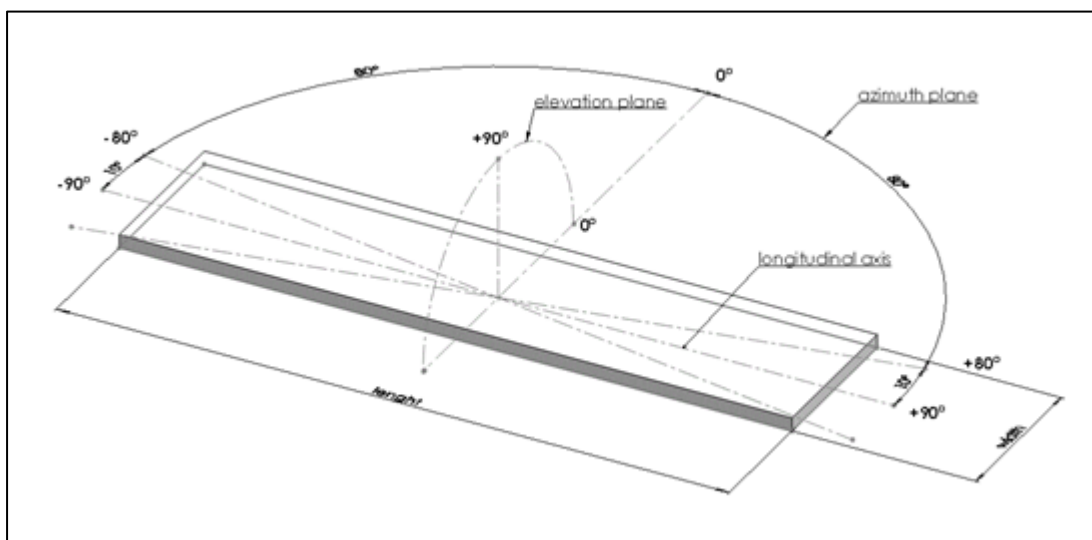
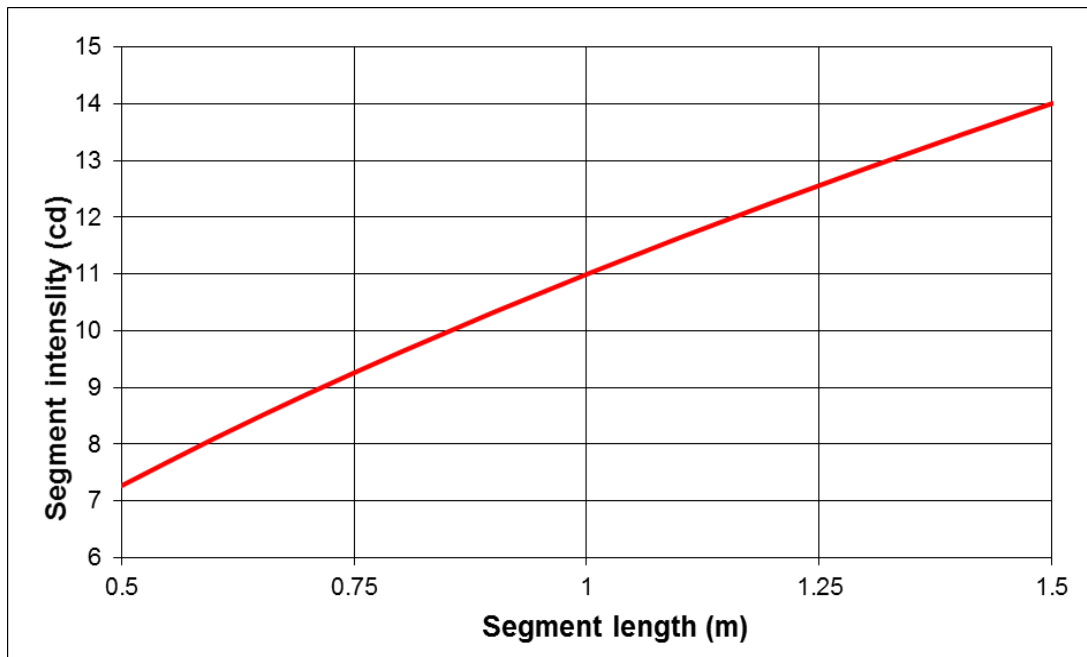

Figure D-2: TD/PM segment intensity versus segment length



Note: Given the minimum gap size of 0.5 m and the minimum coverage of 50%, the minimum segment length is 0.5 m. The maximum segment length is given by selecting the minimum number of segments (16), the minimum access gap size (1.5 m) and the maximum coverage (75%), resulting in a maximum segment length of 1.5 m for the 11.5 m standard TD/PM circle diameter.

- D21 If a segment is made up of a number of individual lighting elements (e.g. LED's) then they should be of the same nominal performance (i.e. within manufacturing tolerances) and be equidistantly spaced throughout the segment to aid textural cueing. Minimum spacing between the illuminated areas of the lighting elements should be 3 cm and maximum spacing 10 cm.

On the assumption that the intensities of the lighting elements will add linearly at longer viewing ranges where intensity is important the minimum intensity of each lighting element (i) should be given by the formula:

$$i = I / n$$

where: I = required minimum intensity of segment at the 'look down' (elevation) angle (see Table D-3).

n = the number of lighting elements within the segment.

Note: The maximum intensity of a lighting element at each angle of elevation should also be divided by the number of lighting elements within the segment.

- D22 If the segment comprises a continuous lighting element (e.g. fibre optic cable, electro luminescent panel), then to achieve textural cueing at short range, the element should be masked at 3.0 cm intervals on a 1:1 mark-space ratio.

Colour

D23 The colour of the light emitted by the TD/PM circle should be yellow, as defined in ICAO Annex 14 Volume 1 Appendix 1, paragraph 2.3.1(b), whose chromaticity is within the following boundaries:

Red boundary $y = 0.387$

White boundary $y = 0.908 - x$

Green boundary $y = 0.727x + 0.054$

Note: The above assumes that solid state light sources are used. ICAO Annex 14 Volume 1 Appendix 1, paragraph 2.1.1(b) should be applied if filament light sources are used.

Serviceability

D24 At least 90% of the lighting elements should be operating for the TD/PM circle to be considered serviceable.

The cross marking requirement

Configuration

D25 The white cross marking should be lit using green right-angled lit chevron markings located adjacent to each of the four internal corners of the 9 m x 9 m white cross. Each chevron should be 1.5 to 1.6 m x 1.5 to 1.6 m in size and be spaced by 4.0 m to 4.5 m as shown in Figure D-3.

Figure D-3: Configuration and dimensions of heliport cross marking

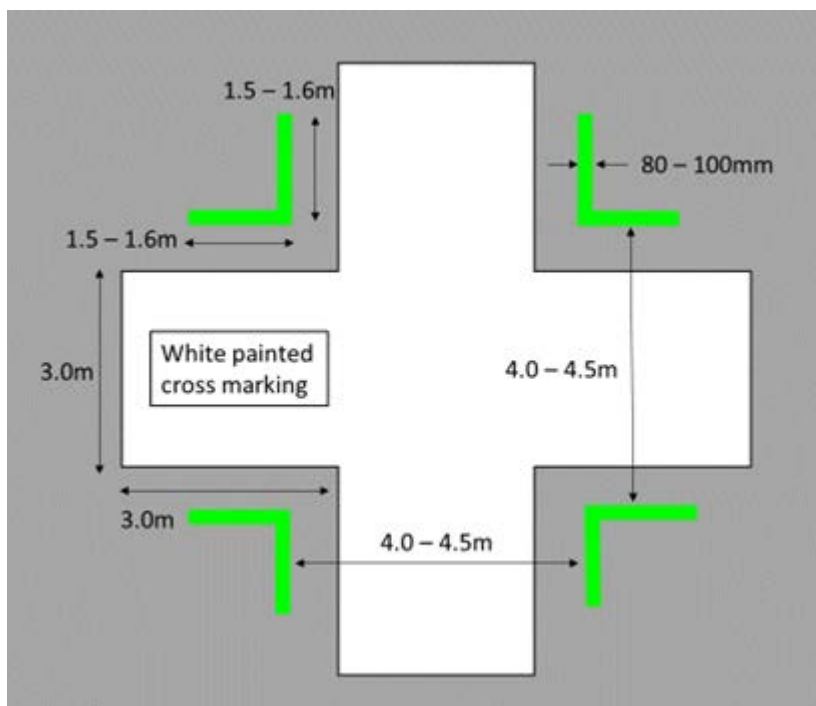

The cross marking should comprise sub-sections of between 80 mm and 100 mm wide. There are no restrictions on the length of the sub-sections, up to a maximum of 1.6 m but, where applicable, the gaps between them should not be greater than 10 cm. The mechanical housing should be coloured white - see Chapter 4 paragraph 4.15.

Mechanical Constraints

- D26 The height of the cross fixtures (e.g. sub-sections) and any associated cabling should be as low as possible and should not exceed 25 mm above the surface of the heliport when fitted. So as not to present a trip hazard, the lighting strips should not present any vertical outside edge greater than 6 mm without chamfering at an angle not exceeding 30° from the horizontal.
- D27 The overall effect of the lighting sub-sections and cabling on deck friction should be minimised. Wherever practical, the surfaces of the lighting sub-sections should meet the minimum deck friction limit coefficient (μ) of 0.6, e.g. on non-illuminated surfaces.
- D28 The cross lighting components, fitments and cabling should be able to withstand a pressure of 2,280 kPa (331 lb/in²), without damage.

Light Intensity

- D29 The intensity of the lighting for each 1.5 m limb of each chevron over all angles of azimuth is given in Table D-4 below.

Note that, for the purposes of demonstrating compliance with this specification, a sub-section of the lighting forming the cross chevrons may be used. The minimum length of the sub-section should be 0.5 m.

Table D-4 Light intensity of the 1.5 m limb of each cross chevron

| Elevation | Intensity | |
|-------------|-----------|-------|
| | Min | Max |
| 2° to 12° | 2 cd | 30 cd |
| >12° to 20° | 0.25 cd | 15 cd |
| >20° to 90° | 0.1 cd | 5 cd |

- D30 The cross chevrons should consist of the same sub-sections throughout.
- D31 If a sub-section of the cross chevrons is made up of individual lighting elements (e.g. LEDs) then they should be of nominally identical performance (i.e. within manufacturing tolerances) and be equidistantly spaced within the sub-section to aid textural cueing. Minimum spacing between the illuminated areas of the lighting elements should be 3 cm and maximum spacing 10 cm.

- D32 Due to the shorter viewing ranges for the cross and the lower intensities involved the minimum intensity of each lighting element (i) for all angles of elevation (0° to 90°) should be given by the formula:

$$i = I / n$$

where I = required minimum intensity of the sub-section at the 'look down' (elevation) angle between 2° and 12° (see Table D-4).

n = the number of lighting elements within the sub-section.

Note: The maximum intensity of each lighting element at any angle of elevation should be the maximum between 2° and 12° (see Table D-4) divided by the number of lighting elements within the sub-section.

- D33 If the cross chevrons are constructed from a continuous light element (e.g. ELP panels or fibre optic cables or panels), the luminance (B) of the 1.5 m arms of the chevrons should be given by the formula:

$$B = I / A$$

where I = intensity of the limb (see Table D-4).

A = the projected lit area at the 'look down' (elevation) angle.

- D34 If the sub-section comprises a continuous lighting element (e.g. ELP, fibre-optic cable), then to achieve textual cueing at short range, the element should be masked at 3.0 cm intervals on a 1:1 mark-space ratio.

Colour

- D35 The colour of the cross chevrons should be green, as defined in ICAO Annex 14 Volume 1 Appendix 1, paragraph 2.3.1(c), whose chromaticity is within the following boundaries:

Yellow boundary $x = 0.310$

White boundary $x = 0.625y - 0.041$

Blue boundary $y = 0.400$

Note: The above assumes that solid state light sources are used. ICAO Annex 14 Volume 1 Appendix 1, paragraph 2.1.1(c) should be applied if filament light sources are used.

Serviceability

- D36 At least 90% of the lighting elements in each of the four chevron markings should be operating for the cross marking to be considered serviceable.

General characteristics

Requirements

The following items are fully defined and form firm requirements.

D37 All lighting components should be tested by an independent test house. The photometrical and colour measurements performed in the optical department of this test house should be accredited according to the version of EN ISO/IEC 17025 current at the time of testing. The angular sampling intervals should be: every 10° in azimuth; every 1° from 0° to 10°, every 2° from 10° to 20° and every 5° from 20° to 90° in elevation.

D38 As regards the attachment of the TD/PM Circle and cross chevrons to the heliport, the failure mode requiring consideration is detachment of elements of the TD/PM circle and cross lighting due to shear loads generated during helicopter landings. The maximum horizontal load may be assumed to be that defined in Chapter 3, Case A, paragraph d i.e. the maximum take-off mass (MTOM) of the largest helicopter for which the heliport is designed multiplied by 0.5, distributed equally between the main undercarriage legs. The requirement applies to components of the circle and cross lighting having an installed height greater than 6mm and a plan view area greater than, or equal to, 200cm². Recessed fittings should be used wherever possible. Use of raised fittings (e.g. domed nuts) should be minimised and, in any event, should not protrude by more than 6mm above the surrounding surface without chamfering at an angle not exceeding 30° from the horizontal.

Note 1: Example – for a helicopter MTOM of 14,600kg, a horizontal load of 35.8kN should be assumed.

Note 2: For components having plan areas up to and including 1,000 cm², the horizontal load may be assumed to be shared equally by all fasteners provided that they are approximately equally spaced. For larger components, the distribution of the horizontal loads should be considered.

D39 Provision should be included in the design and installation of the system to allow for the effective drainage of the heliport areas inside the TD/PM circle and the cross lighting (see Chapter 3 paragraph 3.38). The design of the lighting and its installation should be such that the residual fluid retained by the circle and cross lighting when mounted on a smooth flat plate with a slope of 1:100, a fluid spill of 200 litres at the centre of the helipad will drain from the circle within 2 minutes. The maximum drainage time applies primarily to aviation fuel, but water may be used for test purposes. The maximum drainage time does not apply to fire-fighting agents.

Note: Drainage may be demonstrated using a mock-up of a one quarter segment of a helipad of D-value of at least 20m, configured as shown in Figure

D-4, and a fluid quantity of 100 litres. The surface of the test helipad should have a white or light-coloured finish and the water (or other fluid used for the test) should be of a contrasting colour (e.g. by use of a suitable dye) to assist the detection of fluid remaining after 2 minutes.

Figure D-4: Configuration of quarter segment drainage test mock up

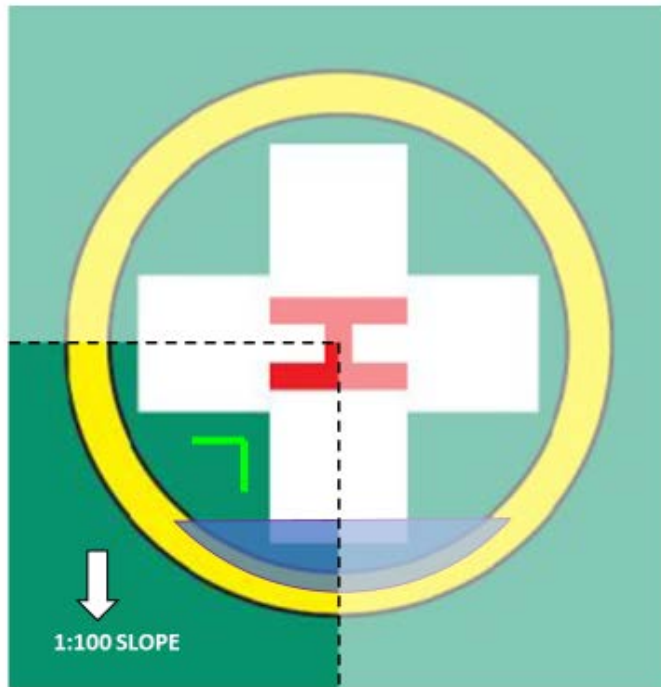

Other considerations

The considerations detailed in this section are presented to make equipment designers aware of the operating environment and customer expectations during the design of products /systems. They do not constitute formal requirements but are desirable design considerations of a good lighting system.

- D40 All lighting components and fitments should meet safety regulations relevant to a heliport environment such as flammability and be tested by a notified body in accordance with applicable directives.
- D41 All lighting components and fitments installed on the surface of the heliport should be resistant to attack by fluids such as: fuel, hydraulic fluid, helicopter engine and gearbox oils; those used for de-icing, cleaning and fire-fighting; any fluids used in the assembly or installation of the lighting, e.g. thread locking fluid. In addition, they should be resistant to UV light, rain, snow and ice. Components should be immersed in each of the fluids individually for a period representative of the likely exposure in-service and then checked to ensure no degradation of mechanical properties (i.e. surface friction and resistance to contact pressure), any discolouration or any clouding of lenses / diffusers. Any other substances that may come into contact with the system that may cause damage should be identified in installation and maintenance documentation.

- D42 All lighting components and fitments that are mounted on the surface of the heliport should be able to operate within a temperature range appropriate for the local ambient conditions.
- D43 All cabling should utilise low smoke/toxicity, flame retardant cable. Any through-the-deck cable routing and connections should use sealed glands, type approved for heliport use.
- D44 All lighting components and fitments should meet IEC International Protection (IP) standards according to IEC 60529 appropriate to their location, use and recommended cleaning procedures. The intent is that the equipment should be compatible with deck cleaning activities using pressure washers and local flooding (i.e. puddling) on the surface of the heliport. It is expected that this will entail meeting at least IP66 (dust tight and resistant to powerful water jetting). IP67 (dust tight and temporary submersion in water) and/or IP69 (dust tight and resistant to close -range high pressure, high temperature jetting) should also be considered and applied where appropriate.
- Note:** Except where flush mounted (e.g. where used to delineate the landing area from an adjacent parking area), perimeter lights need only meet IP66. Lighting equipment mounted on the surface of the heliport (e.g. circle and cross lighting) should also meet IP67. Any lighting equipment that is to be subject to high pressure cleaning (i.e. lighting mounted on the surface of the heliport such as the circle and cross lighting) should also meet IP69.
- D45 Control panels that may be required for heliport lighting systems are not covered in this document. It is the responsibility of the Duty Holder / engineering contractor to select and integrate control panels into the installation safety and control systems, and to ensure that all such equipment complies with the relevant engineering standards for design and operation.

Appendix E

Specifications for helicopter taxiways, taxi-routes and stands at surface level heliports

The following requirements for taxiways / taxi-routes and helicopter stands for provision at surface level heliports are based on amendment 7 of the 4th Edition Annex 14 Volume II (Heliports). The numbering system has been amended to provide sequential references for Appendix E. Future Safety Policy section should be contacted for advice on specifications relating to taxiways / taxi- routes and helicopter stands at elevated heliports:

Helicopter ground taxiways and helicopter ground taxi-routes

Note: A helicopter ground taxiway is intended to permit the surface movement of a wheeled helicopter under its own power.

- E1 The width of a helicopter ground taxiway should not be less than 1.5 times the largest width of the undercarriage (UCW) of the helicopters the helicopter ground taxiway is intended to serve.
- E2 The longitudinal slope of a helicopter ground taxiway should not exceed 3 per cent and the transverse slope should not exceed 2 per cent.
- E3 A helicopter ground taxiway should be capable of withstanding the traffic of the helicopters the helicopter ground taxiway is intended to serve.
- E4 A helicopter ground taxiway should be centred on a ground taxi-route extending symmetrically on each side of the centre line for at least 0.75 times the largest overall width of the helicopters it is intended to serve. (See Figure E-1).

Figure E-1: Helicopter ground taxi-route / taxiway

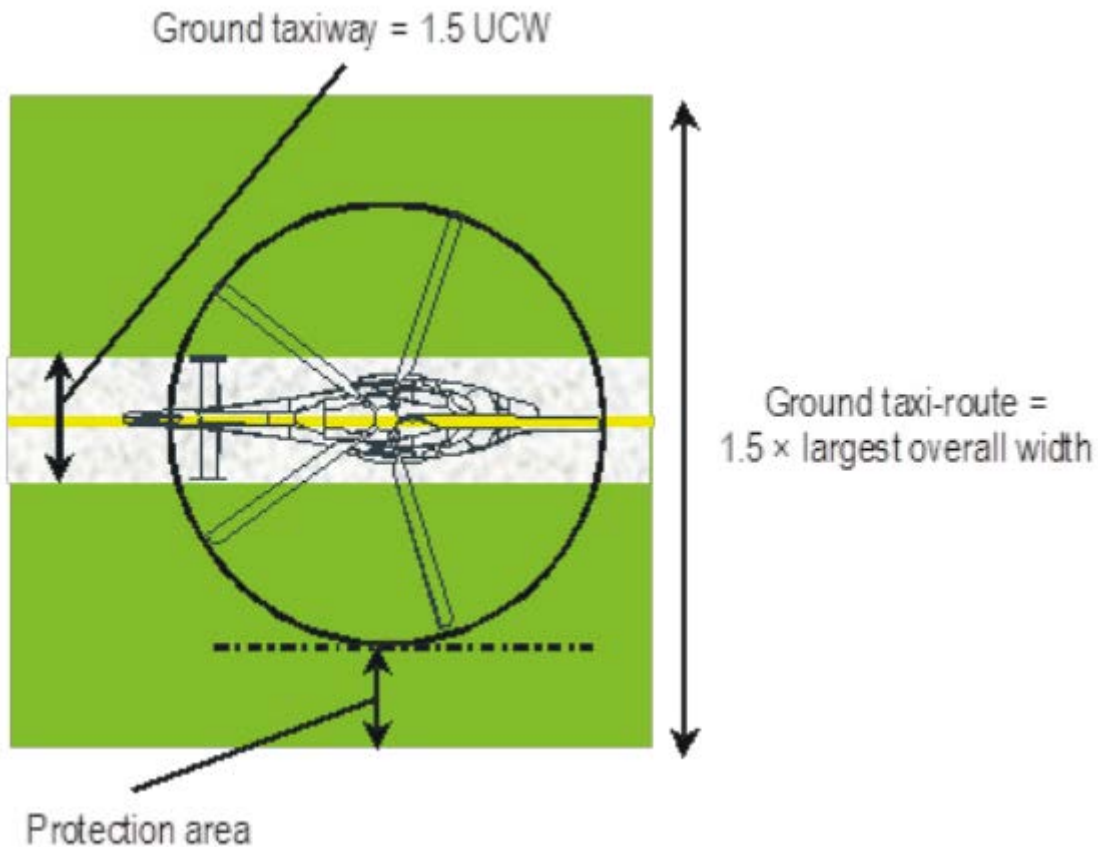

Note: The part of the helicopter ground taxi-route that extends symmetrically on each side of the centre line from 0.5 times the largest overall width of the helicopters it is intended to serve to the outermost limit of the helicopter ground taxi-route is its protection area.

- E5 No fixed object should be permitted above the surface of the ground on a helicopter ground taxi-route, except for objects, which, because of their function, must be located thereon. No mobile object should be permitted on a ground taxi-route during helicopter movements.
- E6 Objects whose function requires them to be located on a helicopter ground taxi-route should not be located at a distance of less than 50 cm from the edge of the helicopter ground taxiway; whereupon objects should not penetrate a plane originating at a height of 25 cm above the surface of the helicopter ground taxiway, at a distance of 50 cm from the edge of the helicopter ground taxiway and sloping upwards and outwards at a gradient of 5 per cent.
- E7 The helicopter ground taxiway and the helicopter ground taxi-route should provide rapid drainage. The surface of a helicopter ground taxi-route should be resistant to the effect of rotor downwash.
- E8 For simultaneous operations, helicopter ground taxi-routes should not overlap.

Helicopter air taxiways and helicopter air taxi-routes

Note: A helicopter air taxiway is intended to permit the movement of a helicopter above the surface at a height normally associated with ground effect and at ground speed less of than 37km/h (20 kt).

- E9 The width of a helicopter air taxiway should be at least two times the largest width of the undercarriage (UCW) of the helicopters that the helicopter air taxiway is intended to serve.
- E10 The slopes of the surface of a helicopter air taxiway should not exceed the slope landing limitations of the helicopters the air taxiway is intended to serve. In any event the transverse slope should not exceed 10 per cent and the longitudinal slope should not exceed 7 per cent.
- E11 A helicopter air taxiway should be centred on an air taxi-route, extending symmetrically on each side of the centre line for a distance at least equal to the largest overall width of the helicopters it is intended to serve. (See Figure E-2)
- E12 No fixed object should be permitted above the surface of the ground on an air taxi-route, except for objects, which, because of their function, must be located thereon. No mobile object should be permitted on an air taxi-route during helicopter movements.
- E13 Objects above ground level whose function requires them to be located on a helicopter air taxi-route should not be located at a distance of less than 1 m from the edge of the helicopter air taxiway; whereupon objects should not penetrate a plane originating at a height of 25 cm above the plane of the helicopter air taxiway, at a distance of 1 m from the edge of the helicopter air taxiway and sloping upwards and outwards at a gradient of 5 per cent.
- E14 The surface of a helicopter air taxi-route should be resistant to the effect of rotor downwash and provide ground effect.
- E15 For simultaneous operations, the helicopter air taxi-routes should not overlap.

Figure E-2: Helicopter air taxi-route / taxiway

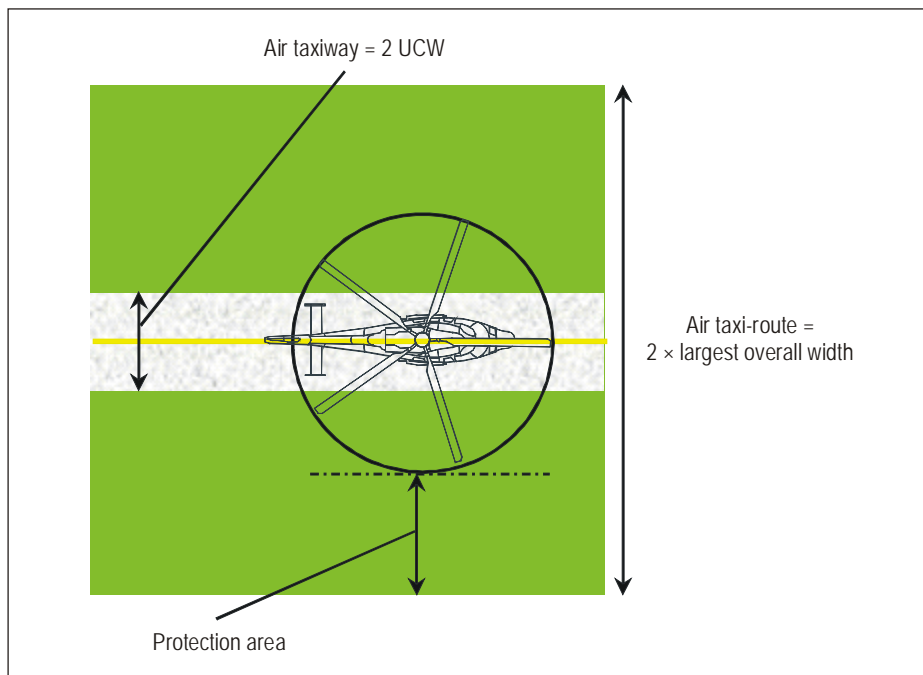

Note: The part of the helicopter air taxi-route that extends symmetrically on each side of the centre line from 0.5 times the largest overall width of the helicopters it is intended to serve to the outermost limit of the helicopter air taxi-route is its protection area.

Helicopter stands

Note 1: The provisions of this section do not specify the location for helicopter stands but allow a high degree of flexibility in the overall design of the heliport. However, it is not considered good practice to locate helicopter stands under a flight path.

Note 2: The requirements on the dimensions of helicopter stands assume the helicopter will turn in a hover when operating over a stand. For a helicopter stand intended to be used for turning on the ground by wheeled helicopters, the dimension of the helicopter stand, including the dimension of the central zone, would need to be significantly increased.

- E16 A helicopter stand intended to be used by helicopters turning in a hover should be of sufficient size to contain a circle of diameter of at least 1.2 D of the largest helicopter the stand is intended to serve. (See Figure E-3).
- E17 Where a helicopter stand is intended to be used for turning in a hover, it should be surrounded by a protection area which extends for a distance of 0.4 D from the edge of the helicopter stand. Therefore the minimum dimension of the stand and protection area should not be less than 2 D.

Figure E-3: Helicopter stand and associated protection area

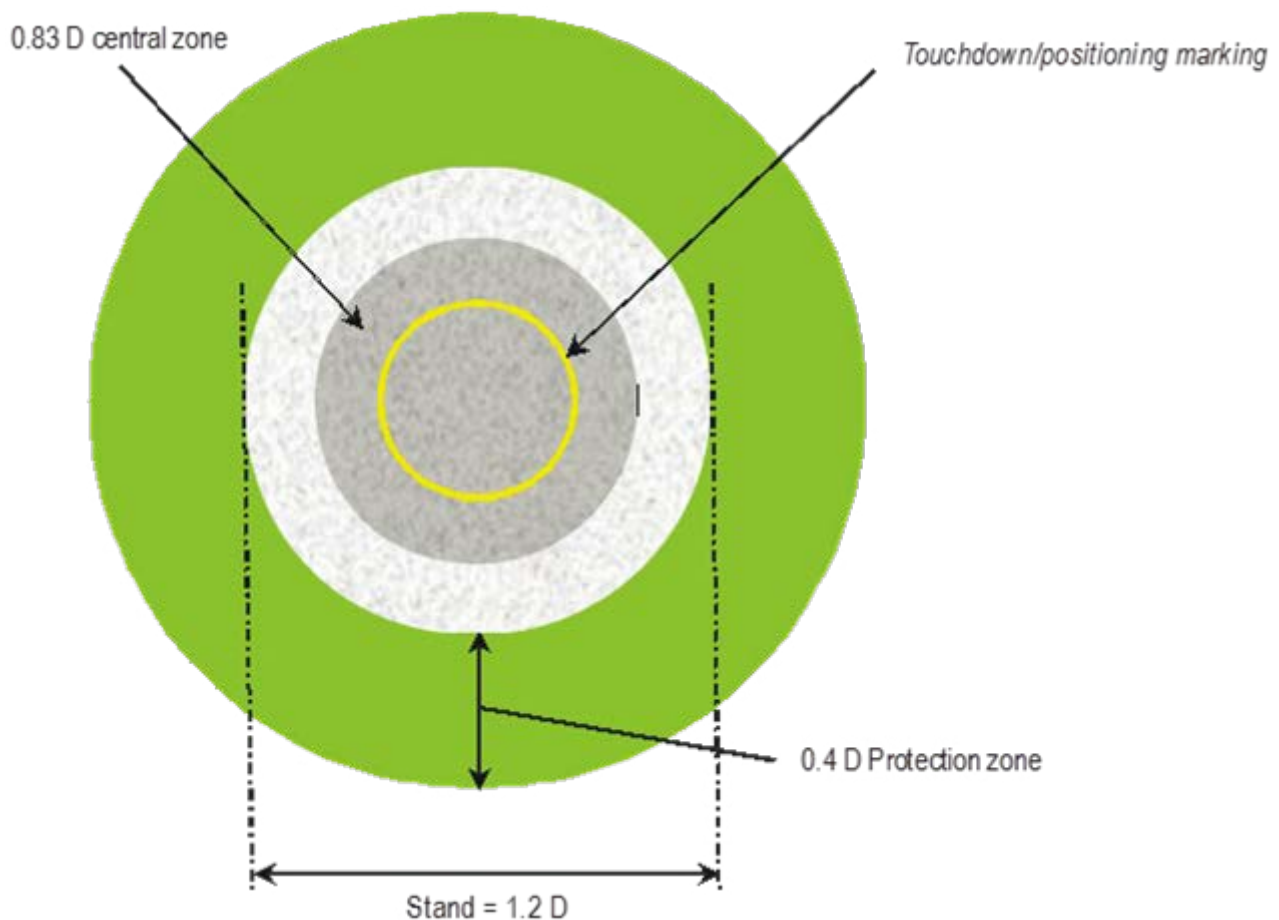

- E18 Where a helicopter stand is intended to be used for taxi-through where the helicopter using the stand is not required to turn, the minimum width of the stand and associated protection area should be that of the taxi-route.
- E19 The helicopter stand should provide rapid drainage but the slope in any direction should not exceed 2 per cent. A helicopter stand and associated protection area intended to be used for air taxiing should provide ground effect.
- E20 No fixed object should be permitted above the surface of the ground on a helicopter stand. No fixed object should be permitted above the surface of the ground in the protection area around a helicopter stand except for objects, which because of their function, must be located there. No mobile object should be permitted on a helicopter stand and the associated protection area during helicopter movements.
- E21 Objects whose function requires them to be located in the protection area should not:
- a) if located at a distance of less than $0.75 D$ from the centre of the helicopter stand, penetrate a plane at a height of 5 cm above the plane of the central zone; and

- b) if located at a distance of $0.75 D$ or more from the centre of the helicopter stand, penetrate a plane at a height of 25 cm above the plane of the central zone and sloping upwards and outwards at a gradient of 5 per cent.

E22 For simultaneous helicopter operations, the protection areas of stands and their associated taxi-routes should not overlap. (See Figure E-4) Where only non-simultaneous operations are envisaged, the protection areas of helicopter stands and their associated taxi-routes may overlap. (See Figure E-5)

Note: When a TLOF is collocated with a helicopter stand, the protection area of the stand should not overlap the protection area of any other helicopter stand or associated taxi route.

E23 The central zone of a helicopter stand should be capable of withstanding the traffic of helicopters it is intended to serve and have a static load-bearing area: a) of diameter not less than $0.83 D$ of the largest helicopter it is intended to serve; or b) for a helicopter stand intended to be used for taxi-through, and where the helicopter using the stand is not required to turn, the same width as the helicopter ground taxiway.

Figure E-4: Helicopter stands for hover turns with air taxi-routes / taxiways - non-simultaneous operations

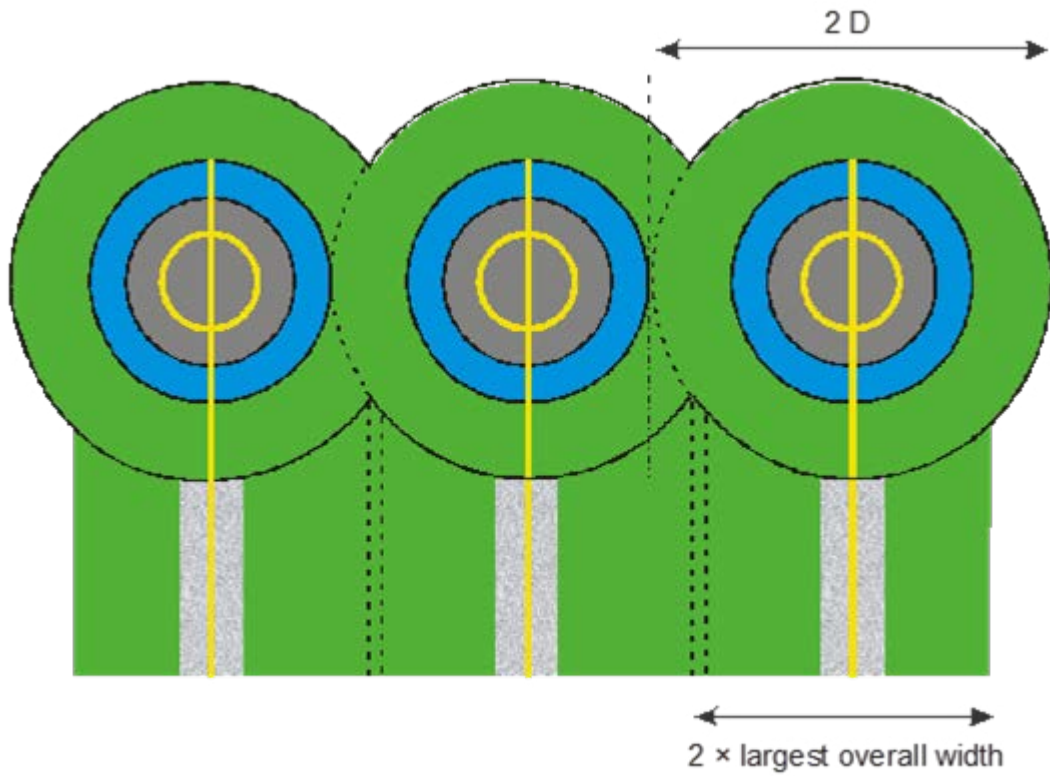
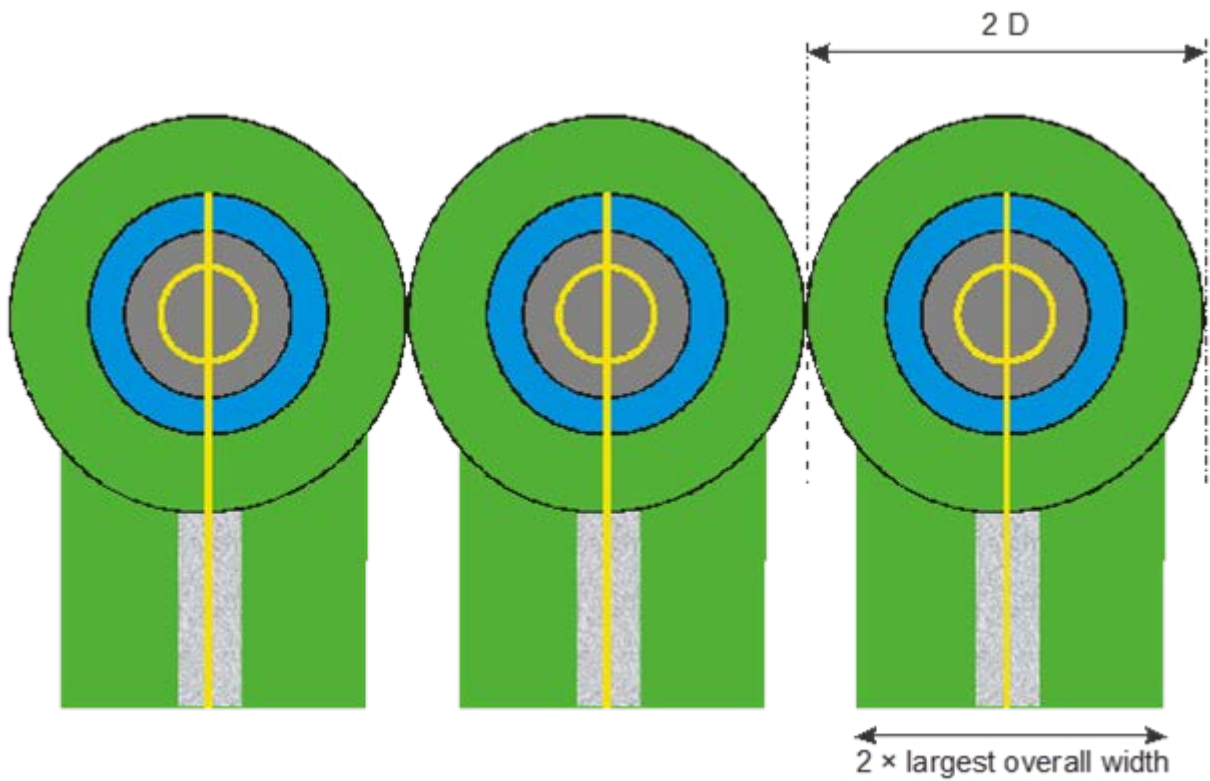

Figure E-5: Helicopter stands for hover turns with air taxi-routes / taxiways - simultaneous operations



Helicopter ground taxiway markings and markers

Note: Ground taxi-routes are not required to be marked.

- E24 The centre line of a helicopter ground taxiway should be identified with a marking, and the edges of a helicopter ground taxiway, if not self-evident, should be identified with markers or markings. Helicopter ground taxiway markings should be along the centre line and, if required, along the edges of a helicopter ground taxiway.
- E25 A helicopter ground taxiway centre line marking should be a continuous yellow line 15 cm in width. Helicopter ground taxiway edge markings should be a continuous double yellow line, each 15 cm in width, and spaced 15 cm apart (nearest edge to nearest edge).
- E26 Helicopter ground taxiway edge markers, where provided, should be frangible and located at a distance of 0.5 m to 3 m beyond the edge of the helicopter ground taxiway and spaced at intervals of not more than 15 m on each side of straight sections and 7.5 m on each side of curved sections with a minimum of four equally spaced markers per section. A helicopter ground taxiway edge marker should be blue.
- E27 A helicopter ground taxiway edge marker should not exceed a plane originating at a height of 25 cm above the plane of the helicopter ground taxiway, at a distance of 0.5 m from the edge of the helicopter ground taxiway and sloping upwards and outwards at a gradient of 5 per cent to a distance of 3 m beyond the edge of the helicopter ground taxiway.
- E28 If the helicopter ground taxiway is to be used at night, the edge markers should be internally illuminated or retro-reflective.

Helicopter air taxiway markings and markers

Note: Air taxi-routes are not required to be marked. Where there is potential for a helicopter air taxiway to be confused with a helicopter ground taxiway, signage may be required to indicate the mode of taxi operations that are permitted.

- E29 The centre line of a helicopter air taxiway or, if not self-evident, the edges of a helicopter air taxiway should be identified with markers or markings.
- E30 A helicopter air taxiway centre line marking or flush in-ground centre line markers should be located along the centre line of the helicopter air taxiway. Helicopter air taxiway edge markings should be located along the edges of a helicopter air taxiway.
- E31 Helicopter air taxiway edge markers, where provided, should be located at a distance of 1 m to 3 m beyond the edge of the helicopter air taxiway.
- E32 A helicopter air taxiway centre line, when on a paved surface, should be marked with a continuous yellow line 15 cm in width.

- E33 The edges of a helicopter air taxiway, when on a paved surface, should be marked with continuous double yellow lines each 15 cm in width, and spaced 15 cm apart (nearest edge to nearest edge).
- E34 A helicopter air taxiway centre line, when on an unpaved surface that will not accommodate painted markings, should be marked with flush in-ground 15 cm wide and approximately 1.5 m in length yellow markers, spaced at intervals of not more than 30 m on straight sections and not more than 15 m on curves, with a minimum of four equally spaced markers per section.
- E35 Helicopter air taxiway edge markers, where provided, should be spaced at intervals of not more than 30 m on each side of straight sections and not more than 15 m on each side of curves, with a minimum of four equally spaced markers per section.
- E36 Helicopter air taxiway edge markers should not penetrate a plane originating at a height of 25 cm above the plane of the helicopter air taxiway, at a distance of 1 m from the edge of the helicopter air taxiway and sloping upwards and outwards at a gradient of 5 per cent to a distance of 3 m beyond the edge of the helicopter air taxiway.
- E37 A helicopter air taxiway edge marker should be of colour(s) that contrast effectively against the operating background. The colour red should not be used for markers.
- E38 If the helicopter air taxiway is to be used at night, helicopter air taxiway edge markers should be either internally illuminated or retro-reflective.

Helicopter stand markings

Note: Helicopter stand identification markings may be provided where there is a need to identify individual stands. Additional markings relating to stand size may be provided. Alignment lines and lead-in / lead-out lines may be provided on a helicopter stand.

- E39 A helicopter stand perimeter marking should be provided on a helicopter stand designed for turning. If a helicopter stand perimeter marking is not practicable, a central zone perimeter marking should be provided instead.
- E40 For a helicopter stand intended to be used for taxi-through and which does not allow the helicopter to turn, a stop line should be provided.
- E41 A helicopter stand perimeter marking on a helicopter stand designed for turning or, a central zone perimeter marking, should be concentric with the central zone of the stand.
- E42 For a helicopter stand intended to be used for taxi-through and which does not allow the helicopter to turn, a stop line should be located on the helicopter ground taxiway axis at right angles to the centre line.

- E43 Alignment lines and lead-in / lead-out lines, where provided, should be located as shown in Figure E-6.

Figure E-6: Helicopter stand markings

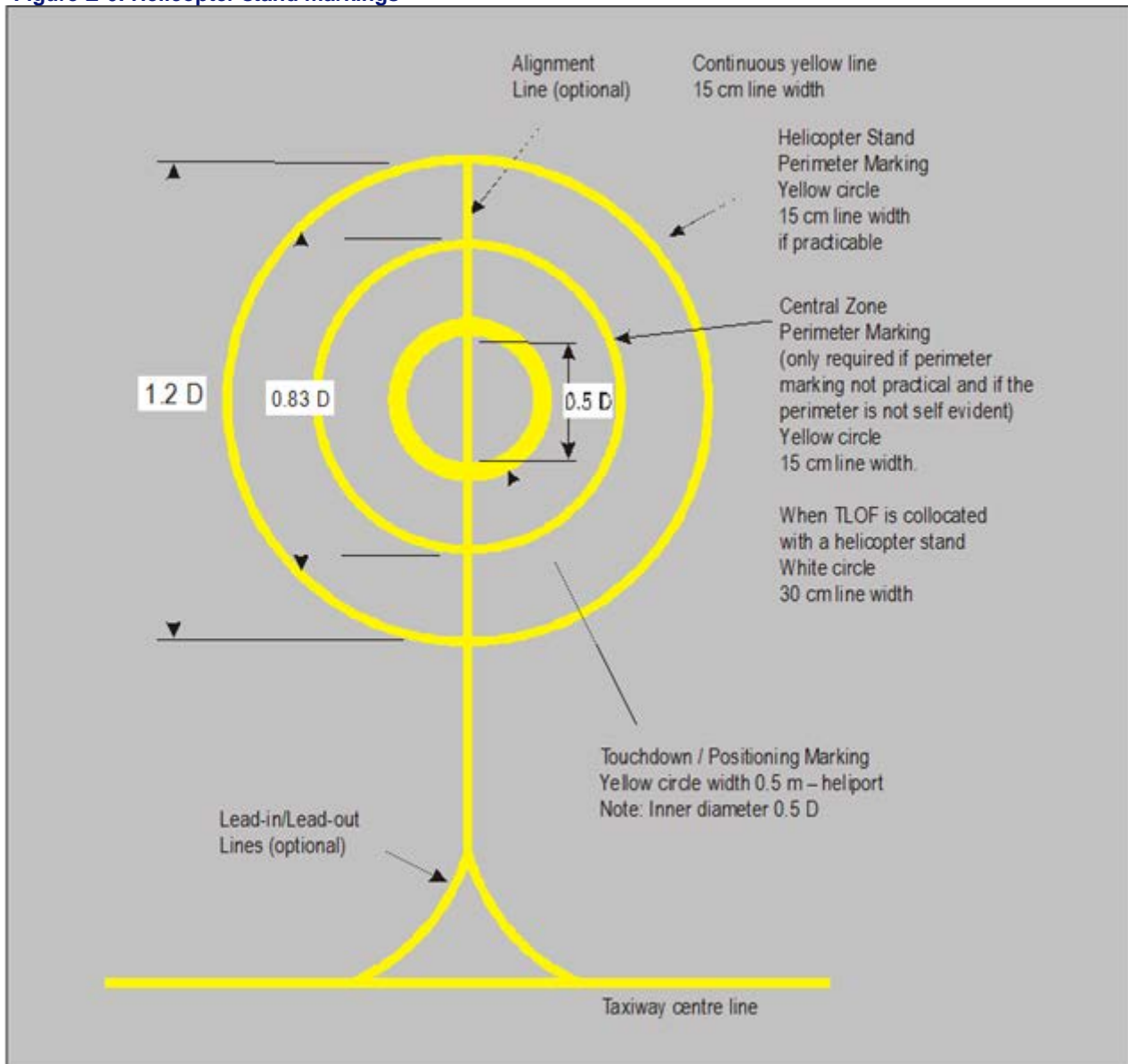

- E44 A helicopter stand perimeter marking or a central zone perimeter marking should be a yellow circle and have a line width of 15 cm.
- E45 For a helicopter stand intended to be used for taxi-through and which does not allow the helicopter to turn, a yellow stop line should not be less than the width of the helicopter ground taxiway and have a line thickness of 50 cm.
- E46 Alignment lines and lead-in / lead-out lines, where provided, should be continuous yellow lines and have a width of 15 cm. Curved portions of alignment lines and lead-in / lead-out lines should have radii appropriate to the most demanding helicopter type the helicopter stand is intended to serve.

- E47 Stand identification markings, where provided, should be marked in a contrasting colour so as to be easily readable.

Appendix F

Initial Emergency Response Requirements for elevated heliports – duties of Responsible Persons

Introduction

- F1 The consequence from fire following an accident or serious incident on an elevated heliport has been assessed as being potentially catastrophic and although the likelihood of a post-crash fire, based on available accident and incident data for operations to elevated (rooftop) heliports in the UK, is assessed as “improbable” (i.e. very unlikely to occur (not known to have occurred)), the overall risk tolerability rating (based on both the likelihood and the consequence) requires that operators of elevated heliports put in place appropriate measures to mitigate the reasonably foreseeable risk of a crash and burn.
- F2 CAA considers that the fire-fighting service (FFS) arrangements described in Chapter 5 of this document provides an adequate mitigation for the improbable, but potentially catastrophic worst-case event; a helicopter accident resulting in post-crash fire. Therefore, the objective for providing integral fire-fighting services (FFS) at an elevated heliport is to rapidly suppress, and bring under control, any fire that occurs within the confines of the heliport response area² to allow occupants of a helicopter an opportunity to escape to safety and to protect people in the building beneath the heliport from the catastrophic consequences of a fire; by ensuring, for a post-crash fire occurring within the response area, that the fire is contained on the heliport and is rapidly suppressed, so it doesn't spread to other parts of the building.
- F3 In the past it was effectively a mandated requirement for an elevated heliport to provide a team of dedicated appropriately trained and equipped fire fighters to ensure an assisted rescue takes place immediately after a post-crash fire has been brought under control– through operating a system of fixed foam monitors and/or of hand-lines provided. This model (see Note below), which invariably requires a significant number of appropriately trained and equipped fire fighters to be ‘on staff’ (whether or not employed by the hospital), when assessed against the risk tolerability rating cannot be automatically justified going forward; based on a full appreciation of the overall risk picture (where robust threat controls³ are

² [CAP 789](#), Annex 3 to Chapter 21 sub-paragraph 12.4 defines the response area as all areas used for manoeuvring, landing, take-off, rejected take-off, (ground) taxiing, air taxiing and parking of helicopters.

³ Threat controls include, but may not be limited to, helicopter operations always conducted to the highest performance standards (PC1), heliport lighting systems installed which provide air crew with the most

introduced to further reduce the likelihood of an accident leading to post-crash fire occurring in the first place).

Note: In the past personnel requirements for an assisted rescue have dictated that a minimum of two trained fire fighters be in attendance for an H1 helicopter movement (up to overall length of 15.0m) and three trained fire fighters be in attendance for an H2 helicopter movement (above 15.0m but not exceeding an overall length of 24.0m), and given the expectation on dedicated trained personnel to fully engage in the rescue of the occupants from a crashed helicopter, which may, or may not, have been on fire, trained fire fighters were required to be appropriately equipped to undertake the task through the provision of rescue equipment and personal protective equipment (PPE) and by the completion of regular periodic (initial and recurrent) training and testing.

- F4 By specifying the use of more effective, higher performing systems and mindful that any response strategy employed has to be proportionate to the overall risk analysis, except for cases where a helicopter is based on the rooftop (e.g. a HEMS operation), or where more than one helicopter is operating to the helipad at the same time, there is a justifiable shift in philosophy away from a purely “assisted rescue” model, so that in the improbable event of a crash and burn incident or accident occurring on an elevated (rooftop) heliport, an expectation is placed upon occupants of the helicopter to escape clear; without having initial assistance from dedicated heliport personnel. Once clear of the immediate incident area there is the possibility for Responsible Persons (RP) to assist casualties and to administer basic first aid and/or for waiting medical teams to remove casualties to a safe place offering immediate medical assistance, which, at a hospital is likely to involve a transfer straight down to the emergency department (ED).
- F5 Through the activation of the Emergency Response Plan (ERP) the local fire and rescue authority should be immediately informed by a Responsible Person of an incident or accident occurring on the heliport, to allow, as necessary, post-initial fire and specialist rescue assistance to be provided by them. To this end the local fire and rescue authorities should be familiarised with access routes to the heliport and with the capabilities of the integral on-site primary fire-fighting system. As a consequence of the expectation that the Responsible Persons present will not of necessity be trained or equipped to engage directly in the rescue of casualties following a crash and burn, it will be for local fire and rescue authorities, following the activation of the heliport’s Emergency Response Plan, to attend the incident and to provide any specialist back-up equipment required for an extricated rescue and/or for the release and removal of the fatally injured. To assist local rescue and

effective visual cues and a requirement introduced in CAP 1264 to predict the flow field around a heliport by conducting wind tunnel testing or CFD methods, thereby controlling the incidence of unwanted environmental (turbulence) effects at the heliport.

fire-fighting authority personnel to perform these tasks, it is prudent for the heliport to consider providing a fully equipped crash equipment box at, or near, rooftop level with an inventory of rescue equipment that is appropriate to helicopter operations (see CAP 437, Chapter 5, Table 1). This inventory is in addition to the requirement in Chapter 5 that hand-controlled water branch pipes be provided for local authority fire fighters at both accesses.

- F6 In determining a policy that is an appropriately risk-based and proportionate response to rescue and fire-fighting arrangements applied at an elevated heliport, it is important to also consider the scope and complexity of the operation at a helicopter landing site and to take account of additional risks that may be present; such as where an elevated heliport is capable of accommodating more than one helicopter (in the case where there are one or more parking spots servicing the landing area) and/or where a helicopter is based on a rooftop heliport during operating hours – an example of this is a HEMS operating base. In the event of having helicopters parked and/or a helicopter based at a heliport, now on the basis of higher exposure to an accident with post-crash fire occurring, there is a stronger case for maintaining a dedicated and appropriately trained rescue and fire-fighting capability during operating hours. Guidance on the provision of rescue and medical equipment, personnel protective equipment and training and manning are provided in [CAP 437](#) and [CAP 789](#), Annex 3 to Chapter 21.

Responsible person(s) – duties to perform including following an incident or accident

- F7 A minimum of one, but preferably two, Responsible Person(s) should be in attendance during each helicopter movement. One RP will usually double-up as the Heliport Manager, and another as a deputy, who between them are responsible for the day-to-day running of the heliport operation. For guidance on daily checks and duties see Appendix A.
- F8 In addition to the daily checks and duties highlighted in Appendix A material (and promulgated in a Heliport Operations Manual), tasks for Responsible Person(s) will include the following responsibilities in respect to the heliport emergency procedures:
1. An RP should be assigned to promulgate and publish a set of clear and concise emergency procedures as part of an Emergency Response Plan (see Chapter 5).
 2. The Emergency Response Plan (Orders), which may form part of the Heliport Operations Manual, should include arrangements for alerting personnel and for summoning externally-based emergency services. These orders should detail procedures for anticipated emergency situations including accidents

and incidents that occur anywhere on the roof of the building where the heliport is located – including the heliport structure.

3. Responsible Person(s) (RP) should be competent in at least the following:
 - have a detailed knowledge of the heliport and the immediate surrounding environment at rooftop level;
 - Instigating procedures to invoke the heliport emergency response plan to deal with the types of emergencies appropriate to the operation, hazards and risks;
 - The procedure and action for activating and de-activating the primary Fixed Foam Application System (i.e. DIFFS) achieving a response as expediently as possible;
 - Be periodically trained in the use of complementary media from hand-held dispensers;
 - Initial Emergency Medical Aid (IEMA) and casualty handling;
 - Maintenance of equipment (usually arranged through the maintenance department)
 - For HEMS operating bases and/or for elevated heliports designed to accommodate more than one helicopter, personnel will need to be fully trained and equipped to operate all the additional equipment provided for a dedicated Rescue and Fire-fighting response at the heliport. Guidance on minimum trained personnel levels is given in CAP 789, Annex 3 to Chapter 21.

Addressing a helicopter crash which does not result in post-crash fire

F9 The primary purpose of Chapter 5 is to provide specifications for an effective integrated heliport fire-fighting system capable of addressing a range of fire situations that may occur on the heliport including a worst-case helicopter crash and burn. However, for modern helicopters designed to meet all the latest certification specifications (in CS29), the likelihood of a fire following a crash landing is reduced, with the prospects of occupants surviving the crash increased, by adopting the latest certification specifications which ensure the following:

- a method to minimize fuel egress from helicopter vents;
- crash resistant fuel tanks;
- self-sealing couplings;
- and energy attenuating seats.

Moreover, occupant survivability is further improved by adopting the latest certification standards for structural crashworthiness and for seat / occupant restraints.

As many of the newer types operating in the HEMS / air ambulance roles have been (or are being) certificated to meet the latest CS-29 standards, it is reasonable to conclude that for a survivable incident or accident occurring anywhere on the heliport response area, the likelihood of a post-crash fire developing following an emergency or crash landing has receded. Section F10, therefore, addresses the incidence of a helicopter crash with no subsequent burn.

- F10 Following a helicopter crash on a rooftop heliport, with no subsequent fire, Responsible Person(s) in attendance may be able to render assistance to occupants of the crashed helicopter to allow them to escape clear of the aircraft and to dispense any immediate first aid, before occupants are transferred to the emergency department using the resources of attending medical teams. In the event of a crash but with no burn, the Emergency Response Plan should be immediately initiated. Seat belt cutters are provided for the use of RPs.

Appendix G

Guidance for floodlighting systems at elevated heliports and heliports on raised structures

Introduction

- G1 Chapter 4, section 4.16 onwards (and Appendix D) sets out the best practice requirements for helideck lighting systems consisting of green perimeter lighting, a yellow lit touchdown / positioning marking circle and red lit heliport identification “H” marking. The statement is made within this section that going into the future reliance on helideck floodlighting as a provision of primary visual cueing is no longer supported. However, CAA has no objection to systems conforming to the guidance contained in this Appendix being used for the purpose of providing a source of illumination for on-deck operations, such as passenger handling (i.e. patient transfer), and where required for lighting the heliport name on the surface.
- G2 In addition floodlights may be retained on existing heliport installations as a back-up for the Circle and “H” lighting.

General considerations for helideck floodlighting

- G3 The whole of the landing area should be adequately illuminated if intended for night use. Experience has shown that floodlighting systems, even when properly aligned, can adversely affect the visual cueing environment by reducing the conspicuity of heliport perimeter lights during the approach, and by causing glare and loss of pilots’ night vision during the hover and landing. Furthermore, floodlighting systems often fail to provide adequate illumination of the centre of the landing area leading to the so called ‘black-hole effect’. It is essential, therefore, that any floodlighting arrangements take full account of these problems. Further guidance on suitable arrangements is provided (below) in section 3 “Improved Floodlighting System”, extracted from a further interim guidance letter issued by CAA to the offshore industry on 9 March 2006 and now updated for this Appendix.
- G4 Although the modified floodlighting schemes described will provide useful illumination of the landing area without significantly affecting the conspicuity of the perimeter lighting and will minimise glare, trials in the offshore environment have demonstrated that neither they nor any other floodlighting system is capable of providing the quality of visual cueing available by illuminating the TD/PM Circle and ‘H’ (see Chapter 4, section 4.16 onwards). These modified floodlighting solutions should therefore be regarded as temporary arrangements

only. It is essential that interim floodlighting solutions are considered in collaboration with the helicopter operator who will wish to fly a non-revenue approach to the heliport at night before confirming the final configuration.

- G5 The floodlighting should be arranged so as not to dazzle the pilot and, if elevated and located off the landing area, the system should not present an obstacle to helicopters landing or taking off from the heliport. All floodlights should be capable of being switched on and off at the pilot's request. Setting up of lights should be undertaken with care to ensure that the issues of adequate illumination and glare are properly addressed and regularly checked.

Improved floodlighting system – (a modified extract from CAA's letter to the offshore industry dated 9 March 2006)

- G6 For heliports located where there are sufficiently high levels of illumination from cultural lighting, the need for any additional floodlighting provision may be reviewed with the helicopter operator(s). This concession assumes that the level of illumination from cultural lighting is also sufficiently high to facilitate deck operations such as unloading the helicopter and the movement of passengers by trolley or stretcher.

- G7 In the absence of sufficient cultural lighting, CAA recommends that heliport operators consider a deck level floodlighting system consisting of between 6 to 8 deck level xenon floodlights (or equivalent) equally spaced along the perimeter of the heliport. In considering this solution, installation owners should ensure that deck level xenon units do not present a source of glare or loss of pilots' night vision on the heliport, and do not hamper the ability of pilots to easily determine the location of the heliport within the hospital complex. It is therefore essential that all lights are maintained in correct alignment. It is also desirable to position the lights such that no light is pointing directly away from the prevailing wind. Floodlights located on the upwind (for the prevailing wind direction) side of the heliport should ideally be mounted so that the centreline of the floodlight beam is at an angle of 45° to the reciprocal of the prevailing wind direction. This will minimise any glare or disruption to the pattern formed by the green perimeter lights for the majority of approaches.

Note: For most hospital heliports it will usually be necessary to fit at least 6 deck level xenon floodlights, but this should be carefully considered in conjunction with the helicopter operator giving due regard to the issues of glare and any loss of definition of the heliport perimeter before further deck level units are procured. The CAA does not recommend more than 8 units even on the largest heliports.

Appendix H

Guidance on airflow testing of onshore elevated helipads

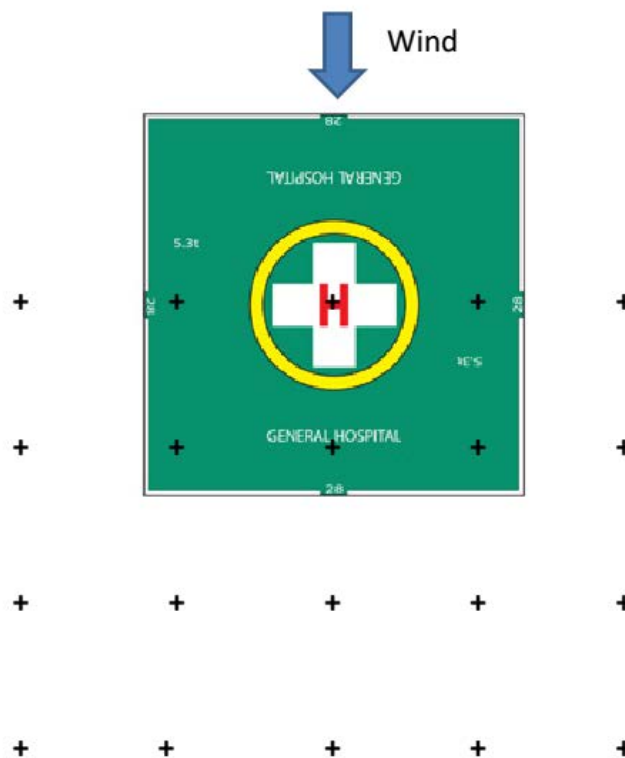
**Notes:**

1. Horizontal spacing (along-wind and cross-wind) between measurement points = 10m.
2. Measurements to be made at all points at 5, 10, 20 and 30m above helipad height.
3. Measurement pattern shown to be repeated for wind speeds and directions commensurate with the ambient wind environment.
4. Wind sector widths should be no greater than 30deg; untested wind sectors should be clearly defined and stated.
5. Wind speed increments should be no greater than 5m/s; the maximum wind speed tested for each wind direction should be clearly stated.
6. Operations should not be conducted in any wind direction more than 15deg. from a tested direction.
7. Operations should not take place at any wind speed greater than the maximum tested wind speed for the corresponding sector.

Appendix I

Risk assessment to determine the need for a dedicated heliport rescue and fire-fighting service (RFFS) at a surface level, mounded or raised HLS

The following factors need to be considered in any risk assessment.:

- The number of movements planned / unplanned.
- The frequency of movements.
- The total number of helicopters in use at the site during peak periods.
- Type of movements i.e. whether conducting commercial passenger operations (CPO) and/or general aviation (GA).
- The number of passengers.
- The types of helicopters in use and their performance characteristics.
- The size and complexity of the response area e.g. other helicopters' present in apron area?
- The nature of the terrain e.g. located near water or swampy areas.
- Whether the heliport is 'elevated' or at surface level.
- Whether the heliport is in a congested or non-congested environment.
- The availability of the local fire and rescue services i.e. how rapidly can they respond to an incident on the heliport?
- The types of helicopters and specific hazards e.g. construction materials used in airframes such as composites i.e. Man-Made Mineral Fibres (MMMF).
- Whether or not an emergency plan has been established.
- Whether or not, for a raised heliport, the structure beneath is occupied or unoccupied

There are a number of systems and features, linked to the certification standards of a helicopter that, if provided, can potentially limit the likelihood of a post-crash fire (PCF) and influence the outcome of a heavy impact or emergency landing e.g. by increasing occupant survivability.

- Seat design to ensure slower deceleration loads on occupants i.e. energy attenuation seats CS29.562 (b)
- Occupant restraints
- Crash Resistant Fuel Systems (CRFS) e.g. compliant with CS29.952 (a).
- Methods to minimise fuel egress through fuel tank vent e.g. seal-sealing fuel lines CS29.952 (c) and CS29.975 (a).
- Fuel lines that are designed, installed and constructed to be crash resistant CS29.952 (f).